

## High Performance Schottky Rectifier, 2 x 10 A

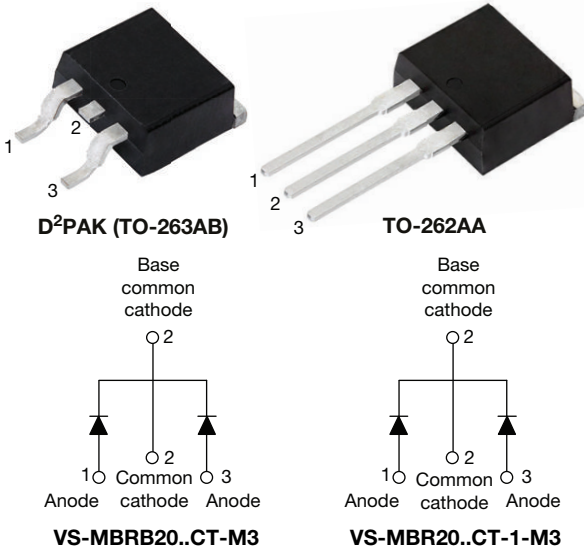

### FEATURES

- 150 °C T<sub>J</sub> operation
- Low forward voltage drop
- High frequency operation
- Center tap D<sup>2</sup>PAK (TO-263 AB) and TO-262AA packages
- High purity, high temperature epoxy encapsulation for enhanced mechanical strength and moisture resistance
- Guard ring for enhanced ruggedness and long term reliability
- Meets MSL level 1, per J-STD-020, LF maximum peak of 245 °C
- Designed and qualified according to JEDEC®-JESD 47
- Material categorization: for definitions of compliance please see [www.vishay.com/doc?99912](http://www.vishay.com/doc?99912)



**RoHS**  
COMPLIANT  
HALOGEN  
**FREE**

### DESCRIPTION

This center tap Schottky rectifier has been optimized for low reverse leakage at high temperature. The proprietary barrier technology allows for reliable operation up to 150 °C junction temperature. Typical applications are in switching power supplies, converters, freewheeling diodes, and reverse battery protection.

### PRIMARY CHARACTERISTICS

I <sub>F(AV)</sub>	2 x 10 A
V <sub>R</sub>	80 V, 90 V, 100 V
V <sub>F</sub> at I <sub>F</sub>	0.70 V
I <sub>RM</sub> max.	6 mA at 125 °C
T <sub>J</sub> max.	150 °C
E <sub>AS</sub>	7 mJ
Package	D <sup>2</sup> PAK (TO-263AB), TO-262AA
Circuit configuration	Common cathode

### MAJOR RATINGS AND CHARACTERISTICS

SYMBOL	CHARACTERISTICS	VALUES	UNITS
I <sub>F(AV)</sub>	Rectangular waveform (per device)	20	A
I <sub>FRM</sub>	T <sub>C</sub> = 133 °C (per leg)	20	
V <sub>R</sub>		80 to 100	V
I <sub>FSM</sub>	t <sub>p</sub> = 5 μs sine	850	A
V <sub>F</sub>	10 A <sub>pk</sub> , T <sub>J</sub> = 125 °C	0.70	V
T <sub>J</sub>	Range	-65 to +150	°C

### VOLTAGE RATINGS

PARAMETER	SYMBOL	VS-MBRB2080CT-M3 VS-MBR2080CT-1-M3	VS-MBRB2090CT-M3 VS-MBR2090CT-1-M3	VS-MBRB20100CT-M3 VS-MBR20100CT-1-M3	UNITS
Maximum DC reverse voltage	V <sub>R</sub>	80	90	100	V
Maximum working peak reverse voltage	V <sub>RWM</sub>				



ABSOLUTE MAXIMUM RATINGS					
PARAMETER	SYMBOL	TEST CONDITIONS		VALUES	UNITS
Maximum average forward current	$I_{F(AV)}$	$T_C = 133\text{ }^\circ\text{C}$ , rated $V_R$	per leg	10	A
			per device	20	
Peak repetitive forward current per leg	$I_{FRM}$	Rated $V_R$ , square wave, 20 kHz, $T_C = 133\text{ }^\circ\text{C}$		20	
Non-repetitive peak surge current	$I_{FSM}$	5 $\mu\text{s}$ sine or 3 $\mu\text{s}$ rect. pulse	Following any rated load condition and with rated $V_{RRM}$ applied	850	
		Surge applied at rated load conditions halfwave, single phase, 60 Hz		150	
Peak repetitive reverse surge current	$I_{RRM}$	2.0 $\mu\text{s}$ , 1.0 kHz		0.5	
Non-repetitive avalanche energy per leg	$E_{AS}$	$T_J = 25\text{ }^\circ\text{C}$ , $I_{AS} = 2\text{ A}$ , $L = 12\text{ mH}$		24	mJ

ELECTRICAL SPECIFICATIONS					
PARAMETER	SYMBOL	TEST CONDITIONS		VALUES	UNITS
Maximum forward voltage drop	$V_{FM}^{(1)}$	10 A	$T_J = 25\text{ }^\circ\text{C}$	0.80	V
		20 A		0.95	
		10 A	$T_J = 125\text{ }^\circ\text{C}$	0.70	
		20 A		0.85	
Maximum instantaneous reverse current	$I_{RM}^{(1)}$	$T_J = 25\text{ }^\circ\text{C}$	Rated DC voltage	0.10	mA
		$T_J = 125\text{ }^\circ\text{C}$		6	
Threshold voltage	$V_{F(TO)}$	$T_J = T_J$ maximum		0.433	V
Forward slope resistance	$r_f$			15.8	m $\Omega$
Maximum junction capacitance	$C_T$	$V_R = 5\text{ V}_{DC}$ (test signal range 100 kHz to 1 MHz), $25\text{ }^\circ\text{C}$		400	pF
Typical series inductance	$L_S$	Measured from top of terminal to mounting plane		8.0	nH
Maximum voltage rate of change	dV/dt	Rated $V_R$		10 000	V/ $\mu\text{s}$

**Note**

(1) Pulse width < 300  $\mu\text{s}$ , duty cycle < 2 %

THERMAL - MECHANICAL SPECIFICATIONS					
PARAMETER	SYMBOL	TEST CONDITIONS		VALUES	UNITS
Maximum junction temperature range	$T_J$			-65 to 150	$^\circ\text{C}$
Maximum storage temperature range	$T_{Stg}$			-65 to 175	
Maximum thermal resistance, junction to case per leg	$R_{thJC}$	DC operation		2.0	$^\circ\text{C/W}$
Typical thermal resistance, case to heatsink	$R_{thCS}$	Mounting surface, smooth and greased		0.50	
Maximum thermal resistance, junction to ambient	$R_{thJA}$	DC operation		50	
Approximate weight				2	g
				0.07	oz.
Mounting torque	minimum maximum	Non-lubricated threads		6 (5)	kgf · cm (lbf · in)
				12 (10)	
Marking device		Case style D <sup>2</sup> PAK (TO-263AB)		MBRB2080CT MBRB2090CT MBRB20100CT	
		Case style TO-262AA		MBR2080CT-1 MBR2090CT-1 MBR20100CT-1	

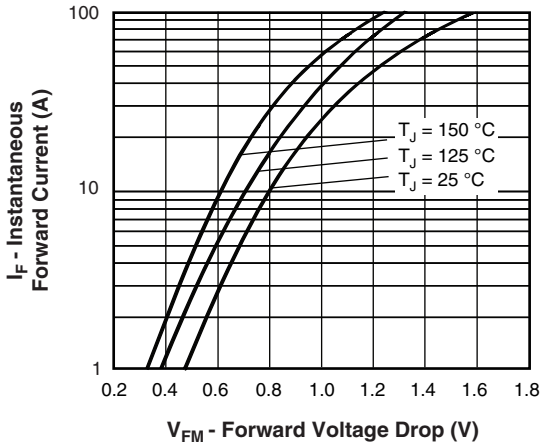

Fig. 1 - Maximum Forward Voltage Drop Characteristics (Per Leg)

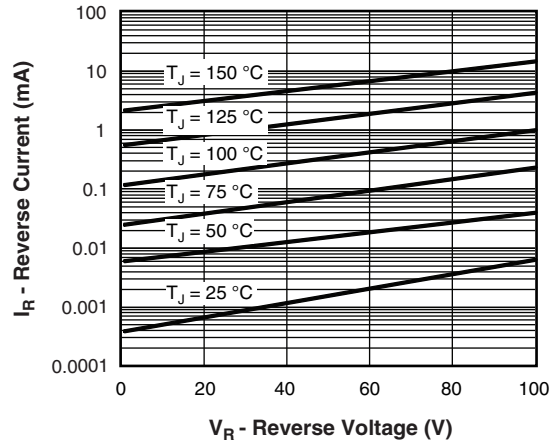

Fig. 2 - Typical Values of Reverse Current vs. Reverse Voltage (Per Leg)

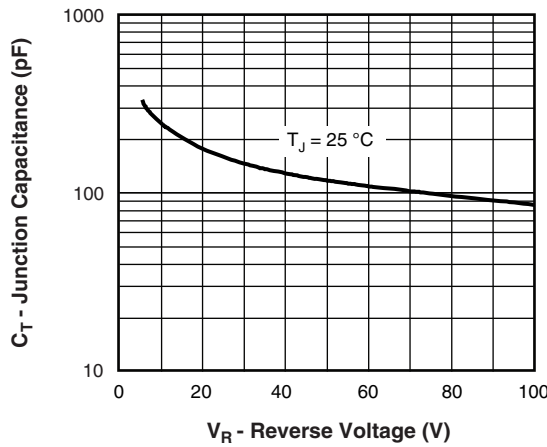

Fig. 3 - Typical Junction Capacitance vs. Reverse Voltage (Per Leg)

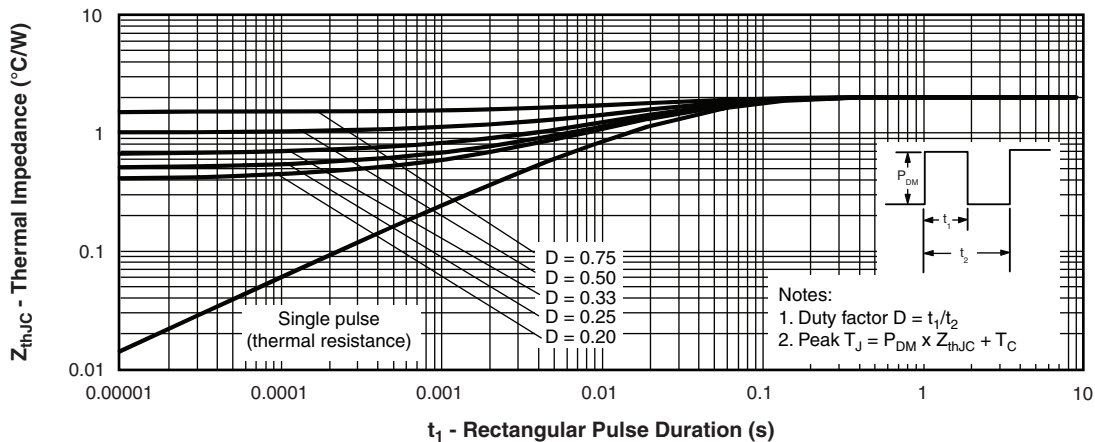

Fig. 4 - Maximum Thermal Impedance  $Z_{thJC}$  Characteristics (Per Leg)

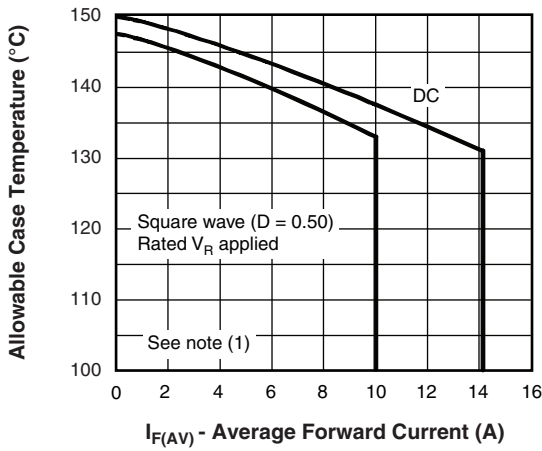

Fig. 5 - Maximum Allowable Case Temperature vs. Average Forward Current (Per Leg)

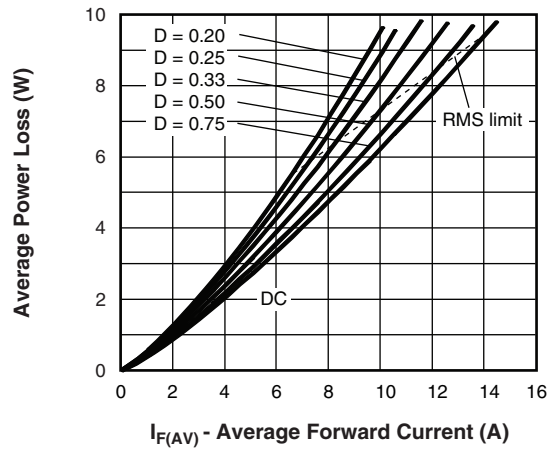

Fig. 6 - Forward Power Loss Characteristics (Per Leg)

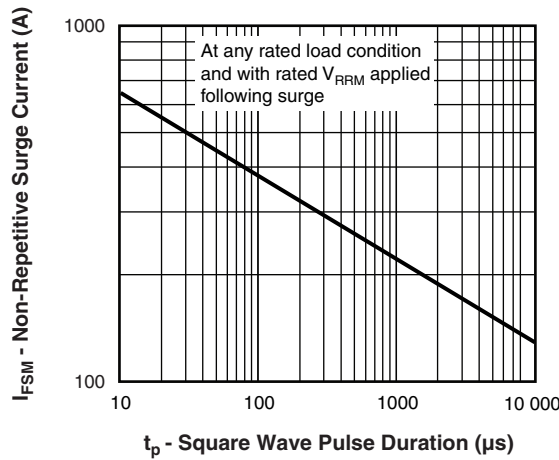

Fig. 7 - Maximum Non-Repetitive Surge Current (Per Leg)

**Note**

- (1) Formula used:  $T_C = T_J - (Pd + Pd_{REV}) \times R_{thJC}$ ;  
 $Pd$  = forward power loss =  $I_{F(AV)} \times V_{FM}$  at  $(I_{F(AV)}/D)$  (see fig. 6);  
 $Pd_{REV}$  = inverse power loss =  $V_{R1} \times I_R (1 - D)$ ;  $I_R$  at  $V_{R1}$  = rated  $V_R$



**ORDERING INFORMATION TABLE**

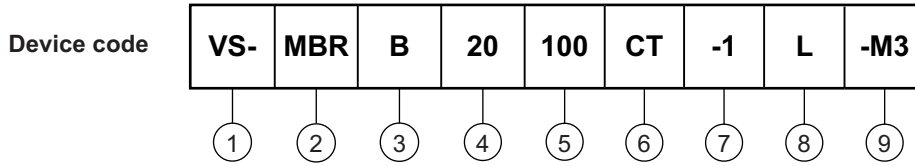

- 1** - Vishay Semiconductors product
- 2** - Essential part number
- 3** -
  - B = D<sup>2</sup>PAK (TO-263AB)      **7** None
  - None = TO-262AA                **7** = -1
- 4** - Current rating (20 = 20 A)      

80 = 80 V
90 = 90 V
100 = 100 V
- 5** - Voltage ratings
- 6** - CT = essential part number
- 7** -
  - None = D<sup>2</sup>PAK (TO-263AB)      **3** = B
  - -1 = TO-262AA                      **3** None
- 8** -
  - None = tube (50 pieces)
  - L = tape and reel (left oriented - for D<sup>2</sup>PAK (TO-263AB) only)
  - R = tape and reel (right oriented - for D<sup>2</sup>PAK (TO-263AB) only)
- 9** - -M3 = halogen-free, RoHS-compliant, and termination lead (Pb)-free

ORDERING INFORMATION		
PREFERRED P/N	BASE QUANTITY	PACKAGING DESCRIPTION
VS-MBRB20100CTL-M3	800	13" diameter plastic tape and reel
VS-MBRB20100CT-M3	50	Antistatic plastic tubes
VS-MBRB20100CTR-M3	800	13" diameter plastic tape and reel
VS-MBRB2080CTL-M3	800	13" diameter plastic tape and reel
VS-MBRB2080CT-M3	50	Antistatic plastic tubes
VS-MBRB2080CTR-M3	800	13" diameter plastic tape and reel
VS-MBRB2090CT-M3	50	Antistatic plastic tubes
VS-MBR20100CT-1-M3	50	Antistatic plastic tubes
VS-MBR2080CT-1-M3	50	Antistatic plastic tubes
VS-MBR2090CT-1-M3	50	Antistatic plastic tubes

LINKS TO RELATED DOCUMENTS		
Dimensions	D <sup>2</sup> PAK (TO-263AB)	<a href="http://www.vishay.com/doc?96164">www.vishay.com/doc?96164</a>
Dimensions	TO-262AA	<a href="http://www.vishay.com/doc?96165">www.vishay.com/doc?96165</a>
Part marking information	D <sup>2</sup> PAK (TO-263AB)	<a href="http://www.vishay.com/doc?95444">www.vishay.com/doc?95444</a>
Part marking information	TO-262AA	<a href="http://www.vishay.com/doc?95443">www.vishay.com/doc?95443</a>
Packaging information		<a href="http://www.vishay.com/doc?96424">www.vishay.com/doc?96424</a>



# D<sup>2</sup>PAK

**DIMENSIONS** in millimeters and inches

Conforms to JEDEC® outline D<sup>2</sup>PAK (SMD-220)



SYMBOL	MILLIMETERS		INCHES		NOTES	SYMBOL	MILLIMETERS		INCHES		NOTES
	MIN.	MAX.	MIN.	MAX.			MIN.	MAX.	MIN.	MAX.	
A	4.06	4.83	0.160	0.190		D1	6.86	8.00	0.270	0.315	3
A1	0.00	0.254	0.000	0.010		E	9.65	10.67	0.380	0.420	2, 3
b	0.51	0.99	0.020	0.039		E1	7.90	8.80	0.311	0.346	3
b1	0.51	0.89	0.020	0.035	4	e	2.54 BSC		0.100 BSC		
b2	1.14	1.78	0.045	0.070		H	14.61	15.88	0.575	0.625	
b3	1.14	1.73	0.045	0.068	4	L	1.78	2.79	0.070	0.110	
c	0.38	0.74	0.015	0.029		L1	-	1.65	-	0.066	3
c1	0.38	0.58	0.015	0.023	4	L2	1.27	1.78	0.050	0.070	
c2	1.14	1.65	0.045	0.065		L3	0.25 BSC		0.010 BSC		
D	8.51	9.65	0.335	0.380	2	L4	4.78	5.28	0.188	0.208	

**Notes**

- (1) Dimensioning and tolerancing per ASME Y14.5 M-1994
- (2) Dimension D and E do not include mold flash. Mold flash shall not exceed 0.127 mm (0.005") per side. These dimensions are measured at the outmost extremes of the plastic body
- (3) Thermal pad contour optional within dimension E, L1, D1 and E1
- (4) Dimension b1 and c1 apply to base metal only
- (5) Datum A and B to be determined at datum plane H
- (6) Controlling dimension: inches
- (7) Outline conforms to JEDEC® outline TO-263AB

## TO-262AA

**DIMENSIONS** in millimeters and inches

Modified JEDEC® outline TO-262



SYMBOL	MILLIMETERS		INCHES		NOTES
	MIN.	MAX.	MIN.	MAX.	
A	4.06	4.83	0.160	0.190	
A1	2.03	3.02	0.080	0.119	
b	0.51	0.99	0.020	0.039	
b1	0.51	0.89	0.020	0.035	4
b2	1.14	1.78	0.045	0.070	
b3	1.14	1.73	0.045	0.068	4
c	0.38	0.74	0.015	0.029	
c1	0.38	0.58	0.015	0.023	4
c2	1.14	1.65	0.045	0.065	
D	8.51	9.65	0.335	0.380	2
D1	6.86	8.00	0.270	0.315	3
E	9.65	10.67	0.380	0.420	2, 3
E1	7.90	8.80	0.311	0.346	3
e	2.54 BSC		0.100 BSC		
L	13.46	14.10	0.530	0.555	
L1	-	1.65	-	0.065	3
L2	3.56	3.71	0.140	0.146	

**Notes**

- (1) Dimensioning and tolerancing as per ASME Y14.5M-1994
- (2) Dimension D and E do not include mold flash. Mold flash shall not exceed 0.127 mm (0.005") per side. These dimensions are measured at the outmost extremes of the plastic body
- (3) Thermal pad contour optional within dimension E, L1, D1 and E1
- (4) Dimension b1 and c1 apply to base metal only
- (5) Controlling dimension: inches
- (6) Outline conform to JEDEC® TO-262 except A1 (max.), b (min., max.), b1 (min.), b2 (max.), c (min.), c1(min.), c2 (max.), D (min.), E (max.), L1 (max.), L2 (min., max.)



## Disclaimer

ALL PRODUCT, PRODUCT SPECIFICATIONS AND DATA ARE SUBJECT TO CHANGE WITHOUT NOTICE TO IMPROVE RELIABILITY, FUNCTION OR DESIGN OR OTHERWISE.

Vishay Intertechnology, Inc., its affiliates, agents, and employees, and all persons acting on its or their behalf (collectively, "Vishay"), disclaim any and all liability for any errors, inaccuracies or incompleteness contained in any datasheet or in any other disclosure relating to any product.

Vishay makes no warranty, representation or guarantee regarding the suitability of the products for any particular purpose or the continuing production of any product. To the maximum extent permitted by applicable law, Vishay disclaims (i) any and all liability arising out of the application or use of any product, (ii) any and all liability, including without limitation special, consequential or incidental damages, and (iii) any and all implied warranties, including warranties of fitness for particular purpose, non-infringement and merchantability.

Statements regarding the suitability of products for certain types of applications are based on Vishay's knowledge of typical requirements that are often placed on Vishay products in generic applications. Such statements are not binding statements about the suitability of products for a particular application. It is the customer's responsibility to validate that a particular product with the properties described in the product specification is suitable for use in a particular application. Parameters provided in datasheets and / or specifications may vary in different applications and performance may vary over time. All operating parameters, including typical parameters, must be validated for each customer application by the customer's technical experts. Product specifications do not expand or otherwise modify Vishay's terms and conditions of purchase, including but not limited to the warranty expressed therein.

Hyperlinks included in this datasheet may direct users to third-party websites. These links are provided as a convenience and for informational purposes only. Inclusion of these hyperlinks does not constitute an endorsement or an approval by Vishay of any of the products, services or opinions of the corporation, organization or individual associated with the third-party website. Vishay disclaims any and all liability and bears no responsibility for the accuracy, legality or content of the third-party website or for that of subsequent links.

Except as expressly indicated in writing, Vishay products are not designed for use in medical, life-saving, or life-sustaining applications or for any other application in which the failure of the Vishay product could result in personal injury or death. Customers using or selling Vishay products not expressly indicated for use in such applications do so at their own risk. Please contact authorized Vishay personnel to obtain written terms and conditions regarding products designed for such applications.

No license, express or implied, by estoppel or otherwise, to any intellectual property rights is granted by this document or by any conduct of Vishay. Product names and markings noted herein may be trademarks of their respective owners.