



## High Speed Infrared Emitting Diodes, 890 nm, Surface Emitter Technology

VSMY2890RGX01



VSMY2890GX01



### DESCRIPTION

As part of the [SurfLight™](#) portfolio, the VSMY2890 series are infrared, 890 nm emitting diodes based on GaAlAs surface emitter chip technology with extreme high radiant intensities, high optical power and high speed, molded in clear, untinted plastic packages (with lens) for surface mounting (SMD).

### APPLICATIONS

- Automotive sensors
- Photointerrupters
- Emitter source for proximity sensors
- IR illumination

### FEATURES

- Package type: surface-mount
- Package form: GW, RGW
- Dimensions (L x W x H in mm): 2.3 x 2.3 x 2.8
- AEC-Q101 qualified
- Peak wavelength:  $\lambda_p = 890$  nm
- Angle of half intensity:  $\phi = \pm 10^\circ$
- Suitable for high pulse current operation
- Terminal configurations: gullwing or reverse gullwing
- Package matches with detector VEMD2500X01 series
- Floor life: 4 weeks, MSL 2a, according to J-STD-020
- Material categorization: for definitions of compliance please see [www.vishay.com/doc?99912](http://www.vishay.com/doc?99912)



PRODUCT SUMMARY				
COMPONENT	$I_e$ (mW/sr) at $I_F = 100$ mA	$\phi$ (°)	$\lambda_p$ (nm)	$t_r$ (ns)
VSMY2890RGX01	135	$\pm 10$	890	15
VSMY2890GX01	135	$\pm 10$	890	15

#### Note

- Test conditions see table "Basic Characteristics"

ORDERING INFORMATION			
ORDERING CODE	PACKAGING	REMARKS	PACKAGE FORM
VSMY2890RGX01	Tape and reel	MOQ: 6000 pcs, 6000 pcs/reel	Reverse gullwing
VSMY2890GX01	Tape and reel	MOQ: 6000 pcs, 6000 pcs/reel	Gullwing

#### Note

- MOQ: minimum order quantity



ABSOLUTE MAXIMUM RATINGS (T <sub>amb</sub> = 25 °C, unless otherwise specified)				
PARAMETER	TEST CONDITION	SYMBOL	VALUE	UNIT
Forward current		I <sub>F</sub>	100	mA
Peak forward current	t <sub>p</sub> /T = 0.5, t <sub>p</sub> = 100 μs	I <sub>FM</sub>	200	mA
Surge forward current	t <sub>p</sub> = 100 μs	I <sub>FSM</sub>	1	A
Power dissipation		P <sub>V</sub>	190	mW
Junction temperature		T <sub>J</sub>	100	°C
Operating temperature range		T <sub>amb</sub>	-40 to +85	°C
Storage temperature range		T <sub>stg</sub>	-40 to +100	°C
Soldering temperature	According to Fig. 9, J-STD-020	T <sub>sd</sub>	260	°C
Thermal resistance junction-to-ambient	JESD51	R <sub>thJA</sub>	250	K/W

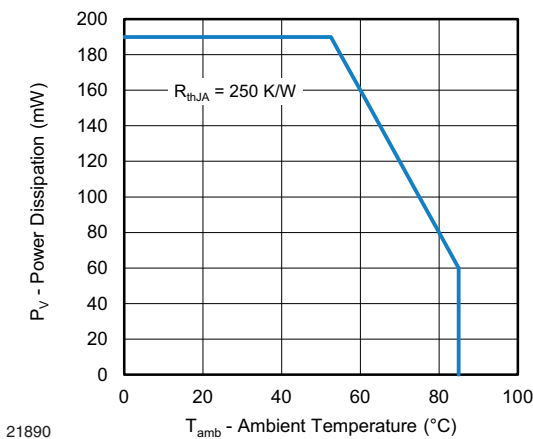

Fig. 1 - Power Dissipation Limit vs. Ambient Temperature

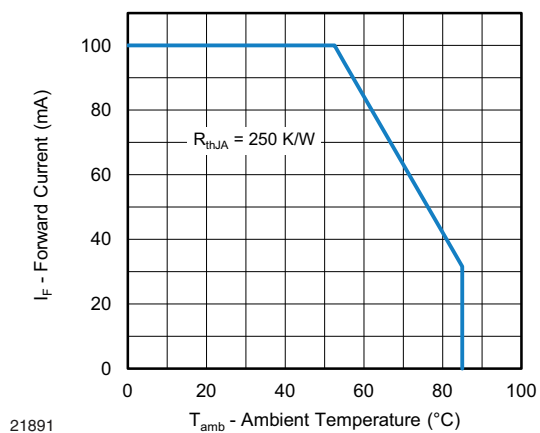

Fig. 2 - Forward Current Limit vs. Ambient Temperature

BASIC CHARACTERISTICS (T <sub>amb</sub> = 25 °C, unless otherwise specified)						
PARAMETER	TEST CONDITION	SYMBOL	MIN.	TYP.	MAX.	UNIT
Forward voltage	I <sub>F</sub> = 100 mA, t <sub>p</sub> = 20 ms	V <sub>F</sub>	-	1.7	1.9	V
	I <sub>F</sub> = 1 A, t <sub>p</sub> = 100 μs	V <sub>F</sub>	-	2.8	-	V
Temperature coefficient of V <sub>F</sub>	I <sub>F</sub> = 100 mA	TK <sub>V<sub>F</sub></sub>	-	-2.0	-	mV/K
Reverse current		I <sub>R</sub>	Not designed for reverse operation			μA
Junction capacitance	V <sub>R</sub> = 0 V, f = 1 MHz, E = 0 mW/cm <sup>2</sup>	C <sub>J</sub>	-	60	-	pF
Radiant intensity	I <sub>F</sub> = 100 mA, t <sub>p</sub> = 20 ms	I <sub>e</sub>	50	135	175	mW/sr
	I <sub>F</sub> = 1 A, t <sub>p</sub> = 100 μs	I <sub>e</sub>	-	1000	-	mW/sr
Radiant power	I <sub>F</sub> = 100 mA, t <sub>p</sub> = 20 ms	φ <sub>e</sub>	-	55	-	mW
Temperature coefficient of radiant power	I <sub>F</sub> = 100 mA	TK <sub>φ<sub>e</sub></sub>	-	-0.12	-	%/K
Angle of half intensity		φ	-	± 10	-	°
Peak wavelength	I <sub>F</sub> = 100 mA	λ <sub>p</sub>	870	890	910	nm
Spectral bandwidth	I <sub>F</sub> = 100 mA	Δλ	-	35	-	nm
Temperature coefficient of λ <sub>p</sub>	I <sub>F</sub> = 100 mA	TK <sub>λ<sub>p</sub></sub>	-	0.3	-	nm/K
Rise time	I <sub>F</sub> = 100 mA, 10 % to 90 %	t <sub>r</sub>	-	15	-	ns
Fall time	I <sub>F</sub> = 100 mA, 10 % to 90 %	t <sub>f</sub>	-	15	-	ns



## BASIC CHARACTERISTICS (T<sub>amb</sub> = 25 °C, unless otherwise specified)

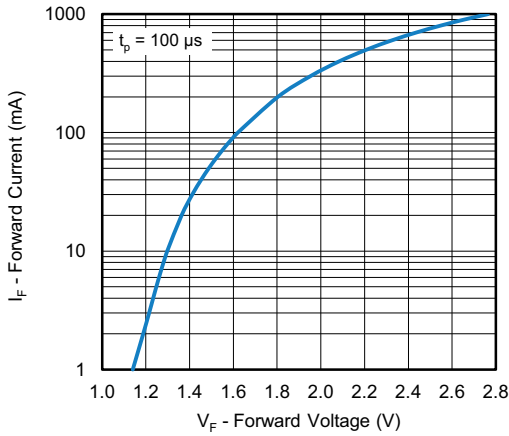

Fig. 3 - Forward Current vs. Forward Voltage

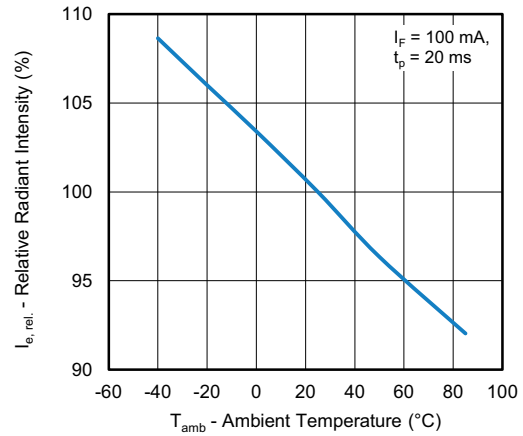

Fig. 6 - Relative Radiant Intensity vs. Ambient Temperature

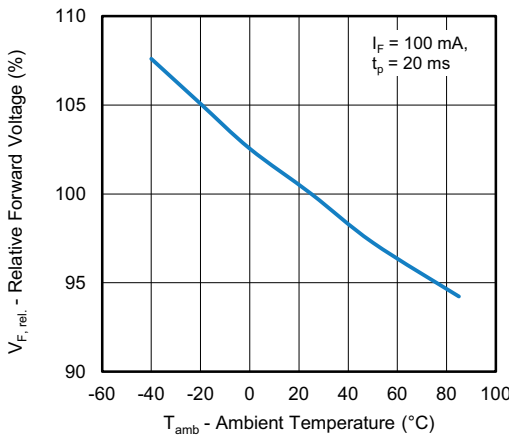

Fig. 4 - Relative Forward Voltage vs. Ambient Temperature

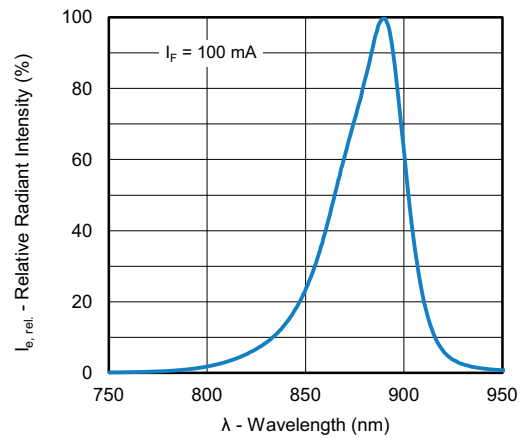

Fig. 7 - Relative Radiant Intensity vs. Wavelength

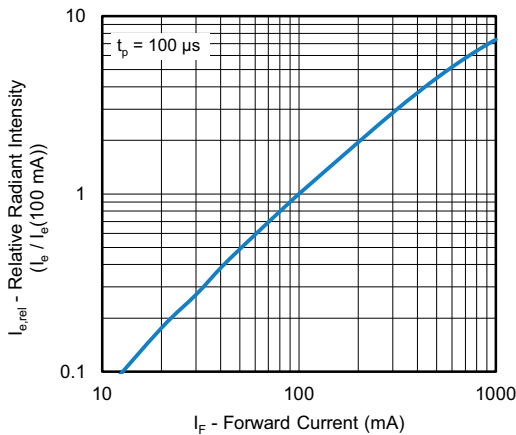

Fig. 5 - Relative Radiant Intensity vs. Forward Current

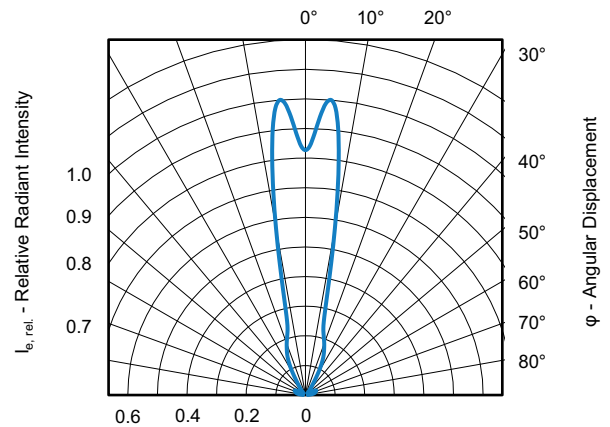
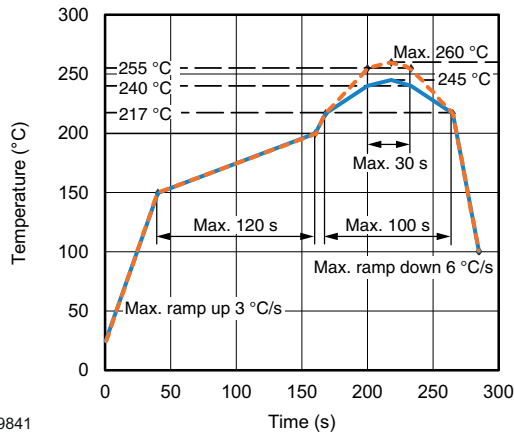

Fig. 8 - Relative Radiant Intensity vs. Angular Displacement



## SOLDER PROFILE



19841

Fig. 9 - Lead (Pb)-free Reflow Solder Profile According to J-STD-020

## DRYPACK

Devices are packed in moisture barrier bags (MBB) to prevent the products from moisture absorption during transportation and storage. Each bag contains a desiccant.

## FLOOR LIFE

Floor life (time between soldering and removing from MBB) must not exceed the time indicated on MBB label:

Floor life: 4 weeks

Conditions:  $T_{amb} < 30\text{ °C}$ ,  $RH < 60\%$

Moisture sensitivity level 2a, according to J-STD-020.

## DRYING

In case of moisture absorption devices should be baked before soldering. Conditions see J-STD-033D or label. Devices taped on reel dry using recommended conditions 192 h at 40 °C (+ 5 °C),  $RH < 5\%$ .



## PACKAGE DIMENSIONS in millimeters: VSMY2890RGX01

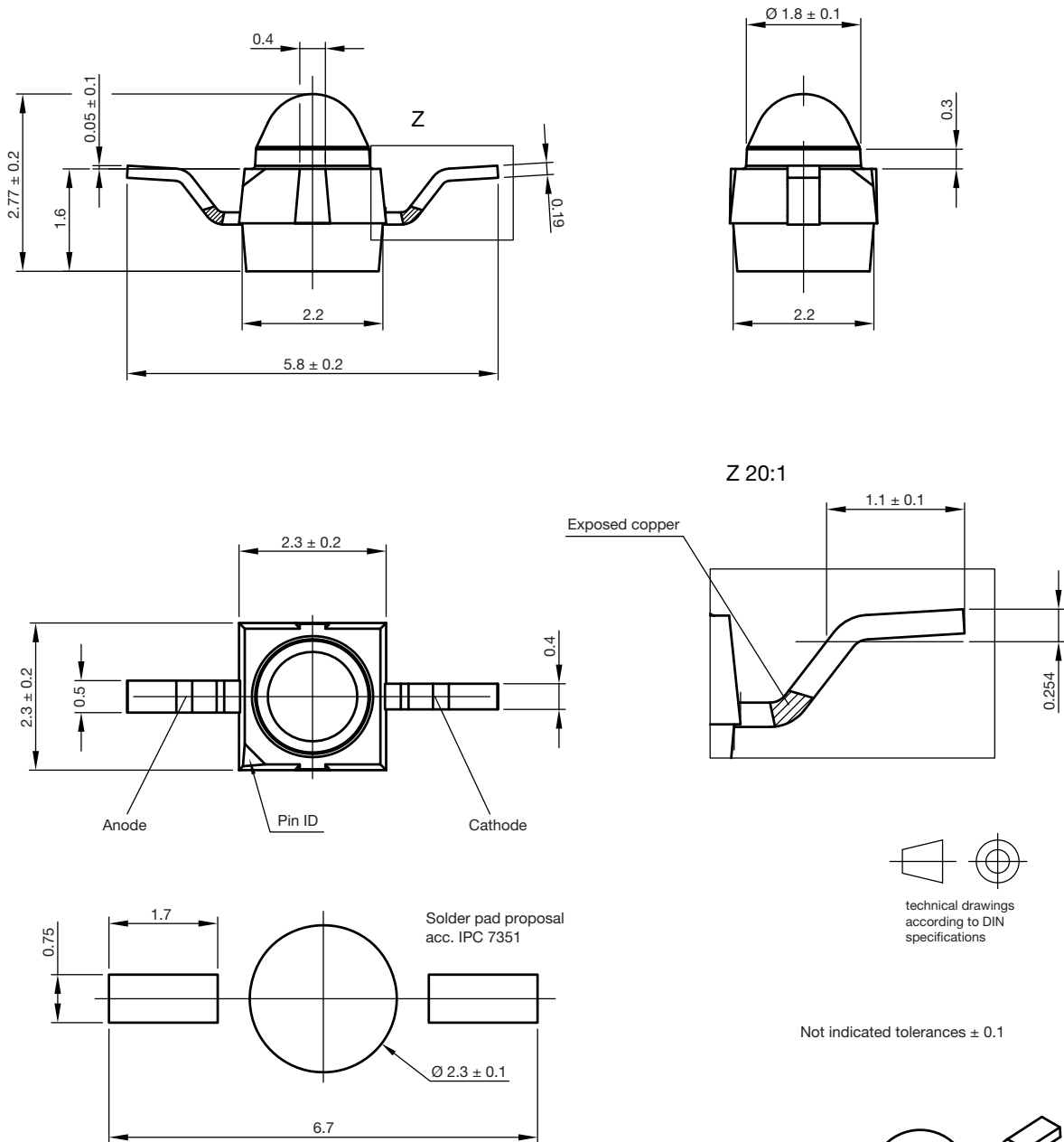

Drawing-No.: 6.544-5391.03-4

Issue: 1; 18.03.10

22100

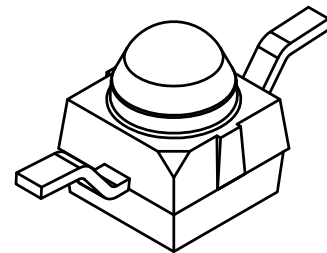



## PACKAGE DIMENSIONS in millimeters: VSMY2890GX01

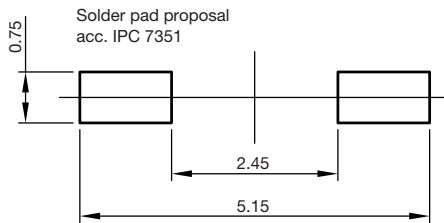
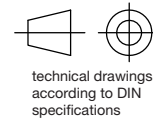
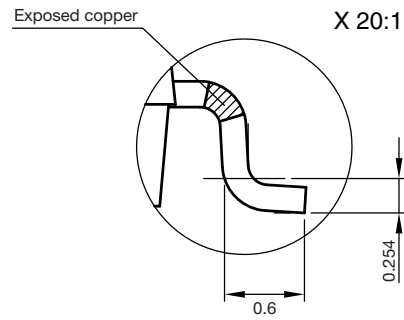
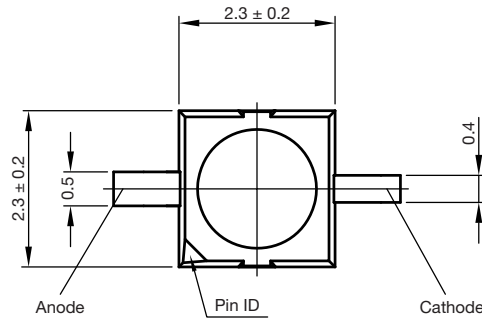
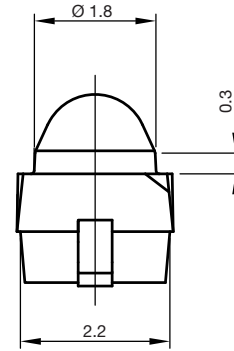
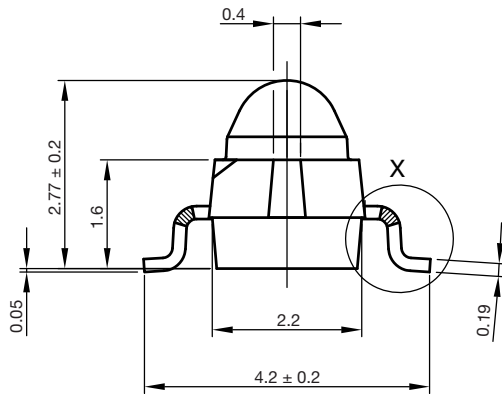

Not indicated tolerances ± 0.1

Drawing-No.: 6.544-5383.03-4  
Issue: 1; 18.03.10  
22099

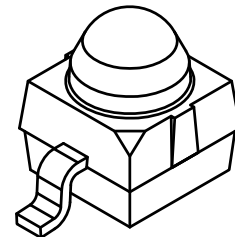

## TAPING AND REEL DIMENSIONS in millimeters: VSMY2890RGX01

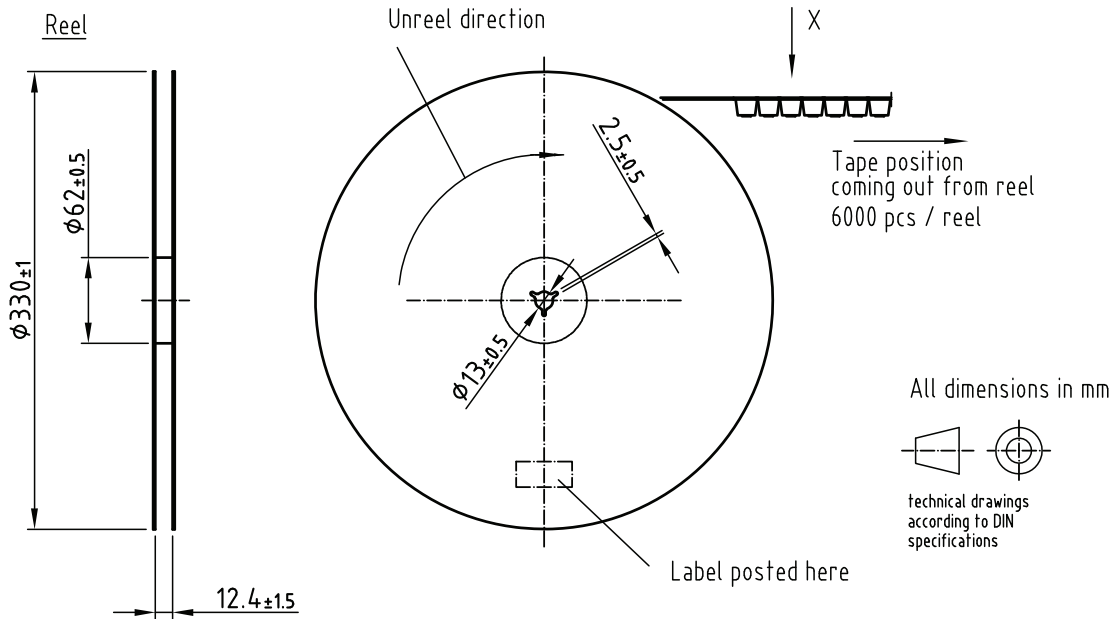

### Leader and trailer tape:

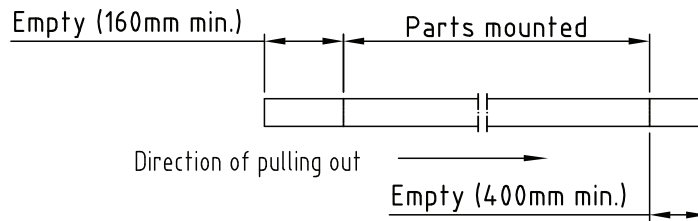

### Terminal position in tape

Device	Lead I	Lead II
VEMT 2000	Collector	Emitter
VEMT 2500		
VEMD 2000	Cathode	Anode
VEMD 2500		
VSMB 2000		
VSMG 2000		
VSMF 2890 RG	Anode	Cathode
VSMB 294008 RG		
VSMY 2xxx		
VSMF 288011 RG		

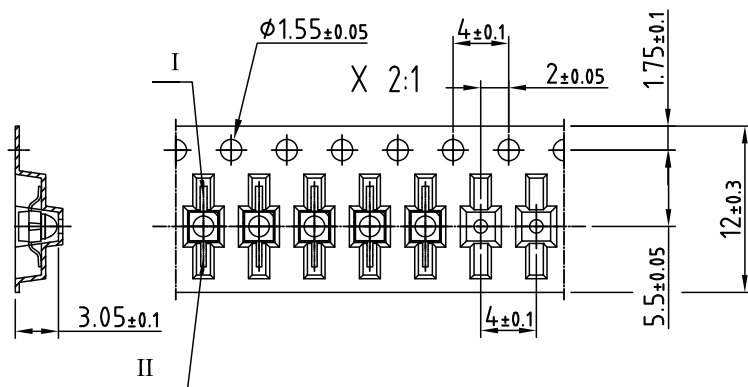

Drawing refers to following types: see table  
Reel dimensions and tape

Drawing-No.: 9.800-5100.01-4  
Issue: preliminary, 11.07.19



## TAPING AND REEL DIMENSIONS in millimeters: VSMY2890GX01

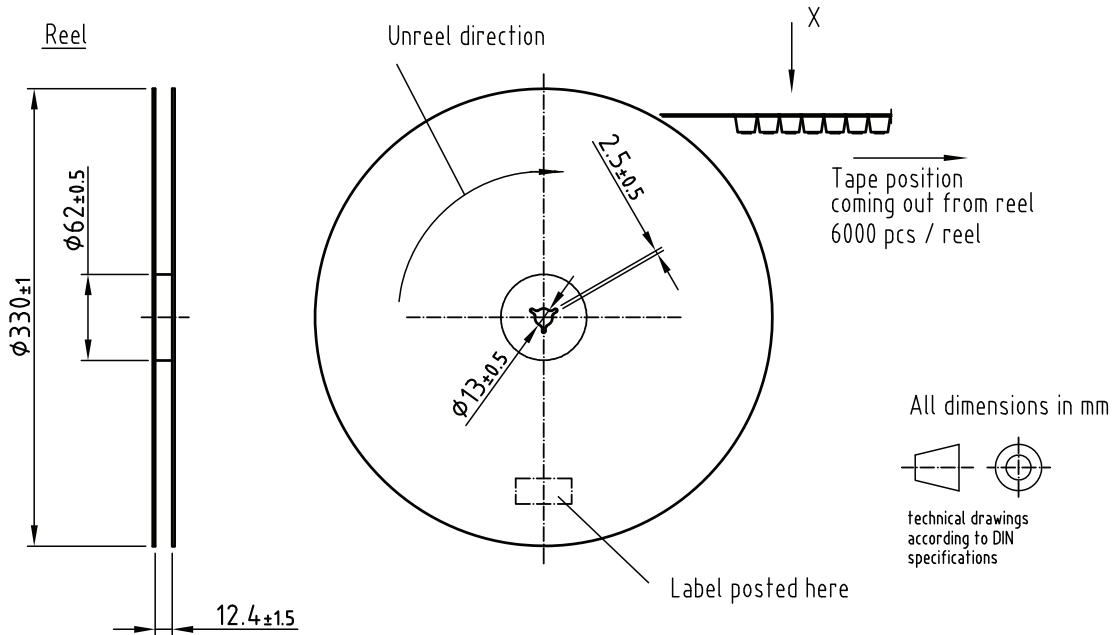

### Leader and trailer tape:

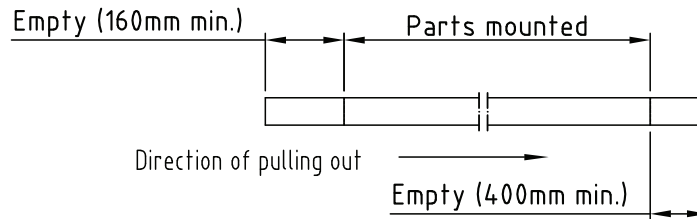

### Terminal position in tape

Device	Lead I	Lead II
VSMB 2020	Cathode	Anode
VSMG 2020		
VEMD 2020		
VEMD 2520		
VSMF 2890 G	Collector	Emitter
VSMB 294008 G		
VEMT 2020	Anode	Cathode
VEMT 2520		
VSMY 2xxx		
VSMF 288011 G		

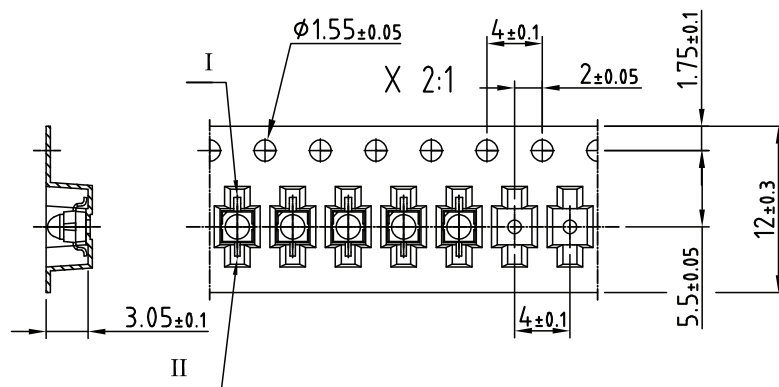

Drawing refers to following types: see table  
Reel dimensions and tape

Drawing-No.: 9.800-5091.01-4  
Issue: preliminary, 11.07.19





## Disclaimer

ALL PRODUCT, PRODUCT SPECIFICATIONS AND DATA ARE SUBJECT TO CHANGE WITHOUT NOTICE TO IMPROVE RELIABILITY, FUNCTION OR DESIGN OR OTHERWISE.

Vishay Intertechnology, Inc., its affiliates, agents, and employees, and all persons acting on its or their behalf (collectively, "Vishay"), disclaim any and all liability for any errors, inaccuracies or incompleteness contained in any datasheet or in any other disclosure relating to any product.

Vishay makes no warranty, representation or guarantee regarding the suitability of the products for any particular purpose or the continuing production of any product. To the maximum extent permitted by applicable law, Vishay disclaims (i) any and all liability arising out of the application or use of any product, (ii) any and all liability, including without limitation special, consequential or incidental damages, and (iii) any and all implied warranties, including warranties of fitness for particular purpose, non-infringement and merchantability.

Statements regarding the suitability of products for certain types of applications are based on Vishay's knowledge of typical requirements that are often placed on Vishay products in generic applications. Such statements are not binding statements about the suitability of products for a particular application. It is the customer's responsibility to validate that a particular product with the properties described in the product specification is suitable for use in a particular application. Parameters provided in datasheets and / or specifications may vary in different applications and performance may vary over time. All operating parameters, including typical parameters, must be validated for each customer application by the customer's technical experts. Product specifications do not expand or otherwise modify Vishay's terms and conditions of purchase, including but not limited to the warranty expressed therein.

Hyperlinks included in this datasheet may direct users to third-party websites. These links are provided as a convenience and for informational purposes only. Inclusion of these hyperlinks does not constitute an endorsement or an approval by Vishay of any of the products, services or opinions of the corporation, organization or individual associated with the third-party website. Vishay disclaims any and all liability and bears no responsibility for the accuracy, legality or content of the third-party website or for that of subsequent links.

Except as expressly indicated in writing, Vishay products are not designed for use in medical, life-saving, or life-sustaining applications or for any other application in which the failure of the Vishay product could result in personal injury or death. Customers using or selling Vishay products not expressly indicated for use in such applications do so at their own risk. Please contact authorized Vishay personnel to obtain written terms and conditions regarding products designed for such applications.

No license, express or implied, by estoppel or otherwise, to any intellectual property rights is granted by this document or by any conduct of Vishay. Product names and markings noted herein may be trademarks of their respective owners.