

DC Film Capacitors MKT Radial Potted Type

FEATURES

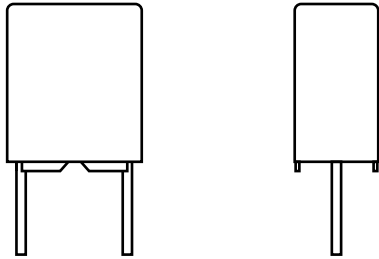

- 5.08 mm lead pitch
- Supplied loose in box, taped on ammpack or reel
- AEC-Q200 qualified (rev. D)
- Material categorization: for definitions of compliance please see www.vishay.com/doc?99912

 AUTOMOTIVE
GRADE

RoHS
COMPLIANT

APPLICATIONS

Blocking and coupling, bypass and energy reservoir, telecom, industrial, consumer.

QUICK REFERENCE DATA	
Capacitance range (E12 series)	0.001 μ F to 1.5 μ F
Capacitance tolerance	$\pm 10\%$, $\pm 5\%$
Rated DC voltage	50 V, 63 V, 250 V, 400 V, 630 V
Rated AC voltage	32 V, 40 V, 63 V, 160 V, 220 V
Climatic testing class acc. to IEC 60068-1	55/100/56 for rated voltage 50 V and 63 V 55/105/56 for rated voltage > 63 V
Maximum application temperature	100 °C for rated voltage 50 V and 63 V 105 °C for rated voltage > 63 V
Rated temperature	85 °C
Reference standards	IEC 60384-2
Dielectric	Polyester film
Electrodes	Metallized
Construction	Mono construction  Triple construction for 630 V, 0.00068 μ F to 0.0018 μ F 
Encapsulation	Flame retardant plastic case and epoxy resin (UL-class 94 V-0)
Leads	Tinned wire
Marking	C-value; tolerance; rated voltage; manufacturer's symbol; year and week of manufacture; manufacturer's type
Performance grade	Grade 1 (long life)

Note

- For more detailed data and test requirements, contact dc-film@vishay.com

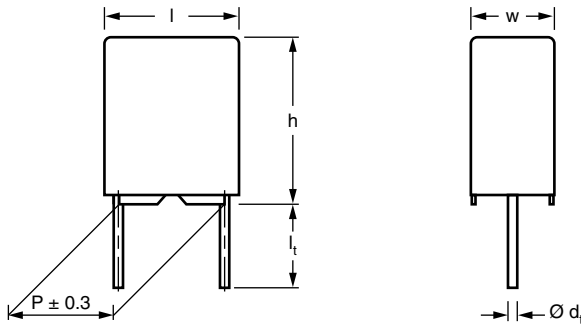
DIMENSIONS in millimeters

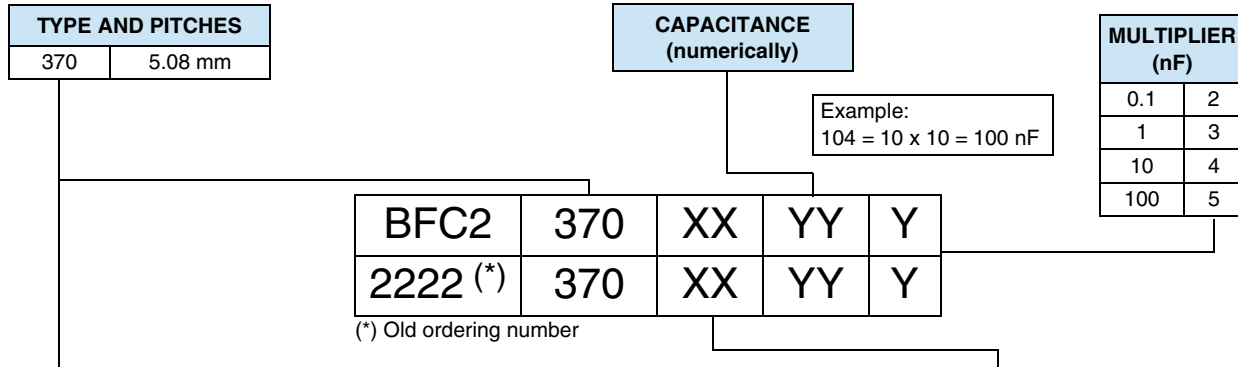
COMPOSITION OF CATALOG NUMBER

TYPE	PACKAGING	LEAD CONFIGURATION	PREFERRED TYPES				
			C-TOL.	63 V	100 V	250 V	400 V
370 (standard size)	Loose in box	Lead length 4.0 mm + 1.0 mm/- 0.5 mm	± 10 %	11	21	41	51
			± 5 %	12	22	42	52
	Taped on reel (1)	Lead length 26.0 mm ± 2.0 mm	± 10 %	15	25	45	55
			± 5 %	16	26	46	56
		H = 18.5 mm; P ₀ = 12.7 mm; Reel diameter = 356 mm	± 10 %	18	28	48	58
			± 5 %	19	29	49	59
Ammopack (2)	H = 18.5 mm; P ₀ = 12.7 mm	± 10 %	75	85	35	65	
		± 5 %	76	86	36	66	

TYPE	PACKAGING	LEAD CONFIGURATION	PREFERRED TYPES				
			C-TOL.	100 V	250 V	400 V	630 V
370 (compact size)	Loose in box	Lead length 4.0 mm + 1.0 mm/- 0.5 mm	± 10 %	CE	EE	FE	GE
			± 5 %	CF	EF	FF	GF
	Taped on reel (1)	Lead length 26.0 mm ± 2.0 mm	± 10 %	CH	EH	FH	GH
			± 5 %	CI	EI	FI	GI
		H = 18.5 mm; P ₀ = 12.7 mm; Reel diameter = 356 mm	± 10 %	CL	EL	FL	GL
			± 5 %	CM	EM	FM	GM
	Ammopack (2)	H = 18.5 mm; P ₀ = 12.7 mm	± 10 %	CB	EB	FB	GB
			± 5 %	CC	EC	FC	GC

Notes

- For detailed tape specifications refer to packaging information: www.vishay.com/doc?28139 or end of catalog
- (1) Reel diameter = 356 mm is available on request
- (2) H = in-tape height; P₀ = sprocket hole distance; for detailed specifications refer to packaging information



SPECIFIC REFERENCE DATA (Standard Size)				
DESCRIPTION	VALUE			
	at 1 kHz	at 10 kHz	at 100 kHz	
Tangent of loss angle:				
$C \leq 0.1 \mu\text{F}$	$\leq 75 \times 10^{-4}$	$\leq 130 \times 10^{-4}$	$\leq 220 \times 10^{-4}$	
$0.1 \mu\text{F} < C \leq 0.47 \mu\text{F}$	$\leq 75 \times 10^{-4}$	$\leq 130 \times 10^{-4}$	$\leq 300 \times 10^{-4}$	
$0.47 \mu\text{F} < C \leq 1.5 \mu\text{F}$	$\leq 75 \times 10^{-4}$	$\leq 130 \times 10^{-4}$	-	
Rated voltage pulse slope $(dU/dt)_R$ at	$50 V_{DC}/63 V_{DC}$	$100 V_{DC}$	$250 V_{DC}$	$400 V_{DC}$
	$60 \text{ V}/\mu\text{s}$	$110 \text{ V}/\mu\text{s}$	$330 \text{ V}/\mu\text{s}$	$630 \text{ V}/\mu\text{s}$
R between leads, for $C \leq 0.33 \mu\text{F}$				
at 10 V; 1 min	$> 15\,000 \text{ M}\Omega$			
at 100 V; 1 min		$> 15\,000 \text{ M}\Omega$	$> 30\,000 \text{ M}\Omega$	$> 30\,000 \text{ M}\Omega$
RC between leads				
$0.33 \mu\text{F} < C \leq 1.0 \mu\text{F}$ at 10 V; 1 min	$> 5000 \text{ s}$			
$C > 1.0 \mu\text{F}$ at 10 V; 1 min	$> 1000 \text{ s}$			
$C > 0.33 \mu\text{F}$ at 100 V; 1 min		$> 5000 \text{ s}$		
R between interconnecting leads and case (foil method)	$> 30\,000 \text{ M}\Omega$	$> 30\,000 \text{ M}\Omega$	$> 30\,000 \text{ M}\Omega$	$> 30\,000 \text{ M}\Omega$
Withstanding (DC) voltage (cut off current 10 mA) ⁽¹⁾ ; rise time $\leq 1000 \text{ V/s}$ rise time 100 V/s	100 V; 1 min	160 V; 1 min	400 V; 1 min	640 V; 1 min
Withstanding (DC) voltage between leads and case	200 V; 1 min	200 V; 1 min	500 V; 1 min	800 V; 1 min
Maximum application temperature	100 °C	105 °C		

Note

⁽¹⁾ See "Voltage Proof Test for Metallized Film Capacitors": www.vishay.com/doc?28169

SPECIFIC REFERENCE DATA (Compact Size)				
DESCRIPTION	VALUE			
	at 1 kHz	at 10 kHz	at 100 kHz	
Tangent of loss angle:				
$C \leq 0.1 \mu\text{F}$	$\leq 75 \times 10^{-4}$	$\leq 130 \times 10^{-4}$	$\leq 220 \times 10^{-4}$	
$0.1 \mu\text{F} < C \leq 0.47 \mu\text{F}$	$\leq 75 \times 10^{-4}$	$\leq 130 \times 10^{-4}$	$\leq 300 \times 10^{-4}$	
$C > 0.47 \mu\text{F}$	$\leq 75 \times 10^{-4}$	$\leq 130 \times 10^{-4}$	-	
Rated voltage pulse slope $(dU/dt)_R$ at	$100 V_{DC}$	$250 V_{DC}$	$400 V_{DC}$	$630 V_{DC}$
	$37 \text{ V}/\mu\text{s}$	$44 \text{ V}/\mu\text{s}$	$200 \text{ V}/\mu\text{s}$	$540 \text{ V}/\mu\text{s}$
R between leads, for $C \leq 0.33 \mu\text{F}$				
at 100 V; 1 min	$> 15\,000 \text{ M}\Omega$	$> 30\,000 \text{ M}\Omega$	$> 30\,000 \text{ M}\Omega$	$> 30\,000 \text{ M}\Omega$
RC between leads				
$C > 0.33 \mu\text{F}$ at 100 V; 1 min	$> 5000 \text{ s}$			
R between interconnecting leads and case (foil method)	$> 30\,000 \text{ M}\Omega$	$> 30\,000 \text{ M}\Omega$	$> 30\,000 \text{ M}\Omega$	$> 30\,000 \text{ M}\Omega$
Withstanding (DC) voltage (cut off current 10 mA) ⁽¹⁾ ; rise time $\leq 1000 \text{ V/s}$ rise time 100 V/s	160 V; 1 min	400 V; 1 min	640 V; 1 min	1008 V; 1 min
Withstanding (DC) voltage between leads and case	200 V; 1 min	500 V; 1 min	800 V; 1 min	1260 V; 1 min
Maximum application temperature	100 °C	105 °C		

Note

⁽¹⁾ See "Voltage Proof Test for Metallized Film Capacitors": www.vishay.com/doc?28169



ELECTRICAL DATA AND ORDERING INFORMATION (Standard Size)													
U _{RDC} (V)	CAP. (μF)	DIMENSIONS w x h x l (mm)	MASS (g) ⁽¹⁾	CATALOG NUMBER BFC2 370 XXYYY AND PACKAGING									C-VALUE ..YYY
				AMMOPACK		LOOSE IN BOX				REEL			
				H = 18.5 mm; P ₀ = 12.7 mm		SHORT LEADS		LONG LEADS					
				C-TOL. = ± 10 %	C-TOL. = ± 5 %	C-TOL. = ± 10 %	C-TOL. = ± 5 %	C-TOL. = ± 10 %	C-TOL. = ± 5 %	C-TOL. = ± 10 %	C-TOL. = ± 5 %		
XX (SPQ)	XX (SPQ)	XX (SPQ)	XX (SPQ)	XX (SPQ)	XX (SPQ)	XX (SPQ)	XX (SPQ)	XX (SPQ)	XX (SPQ)	XX (SPQ)			
U _{RAC} = 32 V; PITCH = 5.08 mm ± 0.30 mm; d _t = 0.50 mm ± 0.05 mm													
50	1.2 1.5	6.0 x 11.0 x 7.2	0.64	75... (750)	76... (750)	11... (2000)	12... (2000)	15... (1000)	16... (1000)	18... (1000)	19... (1000)	125 155	
U _{RAC} = 40 V; PITCH = 5.08 mm ± 0.30 mm; d _t = 0.50 mm ± 0.05 mm													
63	0.056 0.068 0.082 0.10 0.12 0.15 0.18	2.5 x 6.5 x 7.2	0.18	75... (2000)	76... (2000)	11... (2000)	12... (2000)	15... (1000)	16... (1000)	18... (2000)	19... (2000)	563 683 823 104 124 154 184	
	0.22 0.27 0.33 0.39 0.47	3.5 x 8.0 x 7.2	0.3	75... (1500)	76... (1500)	11... (2000)	12... (2000)	15... (1000)	16... (1000)	18... (1500)	19... (1500)	224 274 334 394 474	
	0.56 0.68	4.5 x 9.0 x 7.2	0.42	75... (1000)	76... (1000)	11... (2000)	12... (2000)	15... (1000)	16... (1000)	18... (1000)	19... (1000)	564 684	
	0.82 1.0	6.0 x 11.0 x 7.2	0.64	75... (750)	76... (750)	11... (2000)	12... (2000)	15... (1000)	16... (1000)	18... (1000)	19... (1000)	824 105	
	U _{RAC} = 63 V; PITCH = 5.08 mm ± 0.30 mm; d _t = 0.50 mm ± 0.05 mm												
	100	0.0010 0.0012 0.0015 0.0018 0.0022 0.0027 0.0033 0.0039 0.0047 0.0056 0.0068 0.0082	2.5 x 6.5 x 7.2	0.18	85... (2000)	86... (2000)	21... (2000)	22... (2000)	25... (1000)	26... (1000)	28... (2000)	29... (2000)	102 122 152 182 222 272 332 392 472 562 682 822
		0.010 0.012 0.015 0.018 0.022 0.027 0.033 0.039 0.047 0.056 0.068 0.082 0.10	2.5 x 6.5 x 7.2	0.18	85... (2000)	86... (2000)	21... (2000)	22... (2000)	25... (1000)	26... (1000)	28... (2000)	29... (2000)	103 123 153 183 223 273 333 393 473 563 683 823 104
		0.12 0.15 0.18	3.5 x 8.0 x 7.2	0.30	85... (1500)	86... (1500)	21... (2000)	22... (2000)	25... (1000)	26... (1000)	28... (1500)	29... (1500)	124 154 184
		0.22 0.27 0.33	4.5 x 9.0 x 7.2	0.42	85... (1000)	86... (1000)	21... (2000)	22... (2000)	25... (1000)	26... (1000)	28... (1000)	29... (1000)	224 274 334
		0.39 0.47	6.0 x 11.0 x 7.2	0.64	85... (750)	86... (750)	21... (2000)	22... (2000)	25... (1000)	26... (1000)	28... (1000)	29... (1000)	394 474



ELECTRICAL DATA AND ORDERING INFORMATION (Standard Size)												
U _{RDC} (V)	CAP. (μF)	DIMENSIONS w x h x l (mm)	MASS (g) ⁽¹⁾	CATALOG NUMBER BFC2 370 XYYYY AND PACKAGING								C-VALUE ..YYY
				AMMOPACK		LOOSE IN BOX				REEL		
				H = 18.5 mm; P ₀ = 12.7 mm		SHORT LEADS		LONG LEADS				
				C-TOL. = ± 10 %	C-TOL. = ± 5 %	C-TOL. = ± 10 %	C-TOL. = ± 5 %	C-TOL. = ± 10 %	C-TOL. = ± 5 %	C-TOL. = ± 10 %	C-TOL. = ± 5 %	
XX (SPQ)	XX (SPQ)	XX (SPQ)	XX (SPQ)	XX (SPQ)	XX (SPQ)	XX (SPQ)	XX (SPQ)	XX (SPQ)	XX (SPQ)	XX (SPQ)		
U_{RAC} = 160 V; PITCH = 5.08 mm ± 0.30 mm; d_t = 0.50 mm ± 0.05 mm												
250	0.0010	2.5 x 6.5 x 7.2	0.18	35... (2000)	36... (2000)	41... (2000)	42... (2000)	45... (1000)	46... (1000)	48... (2000)	49... (2000)	102
	0.0012											122
	0.0015											152
	0.0018											182
	0.0022											222
	0.0027											272
	0.0033											332
	0.0039											392
	0.0047											472
	0.0056											562
	0.0068	682										
	0.0082	822										
	0.010	103										
	0.012	123										
	0.015	153										
	0.018	183										
	0.022	3.5 x 8.0 x 7.2	0.30	35... (1500)	36... (1500)	41... (2000)	42... (2000)	45... (1000)	46... (1000)	48... (1500)	49... (1500)	223
	0.027											273
0.033	333											
0.039	4.5 x 9.0 x 7.2	0.42	35... (1000)	36... (1000)	41... (2000)	42... (2000)	45... (1000)	46... (1000)	48... (1000)	49... (1000)	393	
0.047											473	
0.056											563	
0.068	6.0 x 11.0 x 7.2	0.64	35... (750)	36... (750)	41... (2000)	42... (2000)	45... (1000)	46... (1000)	48... (1000)	49... (1000)	683	
0.082											823	
0.10											104	
U_{RAC} = 220 V; PITCH = 5.08 mm ± 0.30 mm; d_t = 0.50 mm ± 0.05 mm												
400	0.0010	2.5 x 6.5 x 7.2	0.18	65... (2000)	66... (2000)	51... (2000)	52... (2000)	55... (1000)	56... (1000)	58... (2000)	59... (2000)	102
	0.0012											122
	0.0015											152
	0.0018											182
	0.0022											222
	0.0027											272
	0.0033											332
	0.0039											392
	0.0047											472
	0.0056											562
	0.0068	682										
	0.0082	822										
	0.010	103										
	0.012	123										
	0.015	153										
	0.018	183										
	0.022	3.5 x 8.0 x 7.2	0.30	65... (1500)	66... (1500)	51... (2000)	52... (2000)	55... (1000)	56... (1000)	58... (1500)	59... (1500)	223
	0.027											273
0.033	333											
0.039	4.5 x 9.0 x 7.2	0.42	65... (1000)	66... (1000)	51... (2000)	52... (2000)	55... (1000)	56... (1000)	58... (1000)	59... (1000)	393	
0.047											473	
0.056											563	
0.068	6.0 x 11.0 x 7.2	0.64	65... (750)	66... (750)	51... (2000)	52... (2000)	55... (1000)	56... (1000)	58... (1000)	59... (1000)	683	
0.082											823	
0.10											104	

Notes

- SPQ = Standard Packing Quantity
- ⁽¹⁾ Weight for short lead product only



ELECTRICAL DATA AND ORDERING INFORMATION (Compact Size)													
U _{RDC} (V)	CAP. (μF)	DIMENSIONS w x h x l (mm)	MASS (g) ⁽¹⁾	CATALOG NUMBER BFC2 370 XXYYY AND PACKAGING									C-VALUE ..YYY
				AMMOPACK		LOOSE IN BOX				REEL			
				H = 18.5 mm; P ₀ = 12.7 mm		SHORT LEADS		LONG LEADS					
				C-TOL. = ± 10 %	C-TOL. = ± 5 %	C-TOL. = ± 10 %	C-TOL. = ± 5 %	C-TOL. = ± 10 %	C-TOL. = ± 5 %	C-TOL. = ± 10 %	C-TOL. = ± 5 %		
XX (SPQ)	XX (SPQ)	XX (SPQ)	XX (SPQ)	XX (SPQ)	XX (SPQ)	XX (SPQ)	XX (SPQ)	XX (SPQ)	XX (SPQ)				
U_{RAC} = 40 V; PITCH = 5.08 mm ± 0.30 mm; d_t = 0.50 mm ± 0.05 mm													
100	0.12	3.5 x 8.0 x 7.2	0.30									124	
	0.15											154	
	0.18			CB...	CC...	CE...	CF...	CH...	CI...	CL...	CM...	184	
	0.22			(1500)	(1500)	(2000)	(2000)	(1000)	(1000)	(1500)	(1500)	224	
	0.27											274	
	0.33											334	
0.39	4.5 x 9.0 x 7.2	0.42	CB...	CC...	CE...	CF...	CH...	CI...	CL...	CM...	394		
0.47			(1000)	(1000)	(2000)	(2000)	(1000)	(1000)	(1000)	(1000)	474		
0.56	6.0 x 11.0 x 7.2	0.64	CB...	CC...	CE...	CF...	CH...	CI...	CL...	CM...	564		
				(750)	(750)	(2000)	(2000)	(1000)	(1000)	(1000)	(1000)		
U_{RAC} = 63 V; PITCH = 5.08 mm ± 0.30 mm; d_t = 0.50 mm ± 0.05 mm													
250	0.022	2.5 x 6.5 x 7.2	0.18	EB...	EC...	EE...	EF...	EH...	EI...	EL...	EM...	223	
	0.027			(2000)	(2000)	(2000)	(2000)	(1000)	(1000)	(2000)	(2000)	273	
	0.033	3.5 x 8.0 x 7.2	0.30									333	
	0.039			EB...	EC...	EE...	EF...	EH...	EI...	EL...	EM...	393	
	0.047			(1500)	(1500)	(2000)	(2000)	(1000)	(1000)	(1500)	(1500)	473	
	0.056											563	
	0.068											683	
	0.082	4.5 x 9.0 x 7.2	0.42	EB...	EC...	EE...	EF...	EH...	EI...	EL...	EM...	823	
	0.10			(1000)	(1000)	(2000)	(2000)	(1000)	(1000)	(1000)	(1000)	104	
	0.12	6.0 x 11.0 x 7.2	0.64	EB...	EC...	EE...	EF...	EH...	EI...	EL...	EM...	124	
	0.15			(750)	(750)	(2000)	(2000)	(1000)	(1000)	(1000)	(1000)	154	
	0.18											184	
0.22											224		
U_{RAC} = 160 V; PITCH = 5.08 mm ± 0.30 mm; d_t = 0.50 mm ± 0.05 mm													
400	0.010	2.5 x 6.5 x 7.2	0.18	FB...	FC...	FE...	FF...	FH...	FI...	FL...	FM...	103	
	0.012			(2000)	(2000)	(2000)	(2000)	(1000)	(1000)	(2000)	(2000)	123	
	0.015											153	
	0.018											183	
	0.022	3.5 x 8.0 x 7.2	0.30									223	
	0.027			FB...	FC...	FE...	FF...	FH...	FI...	FL...	FM...	273	
	0.033			(1500)	(1500)	(2000)	(2000)	(1000)	(1000)	(1500)	(1500)	333	
	0.039											393	
	0.047			4.5 x 9.0 x 7.2	0.42	FB...	FC...	FE...	FF...	FH...	FI...	FL...	FM...
	0.056	(1000)	(1000)			(2000)	(2000)	(1000)	(1000)	(1000)	(1000)	563	
	0.068	6.0 x 11.0 x 7.2	0.64	FB...	FC...	FE...	FF...	FH...	FI...	FL...	FM...	683	
	0.082			(750)	(750)	(2000)	(2000)	(1000)	(1000)	(1000)	(1000)	823	
	0.10											104	



ELECTRICAL DATA AND ORDERING INFORMATION (Compact Size)												
U _{RDC} (V)	CAP. (μF)	DIMENSIONS w x h x l (mm)	MASS (g) ⁽¹⁾	CATALOG NUMBER BFC2 370 XXYYY AND PACKAGING								C-VALUE ..YYY
				AMMOPACK		LOOSE IN BOX				REEL		
				H = 18.5 mm; P ₀ = 12.7 mm		SHORT LEADS		LONG LEADS				
				C-TOL. = ± 10 %	C-TOL. = ± 5 %	C-TOL. = ± 10 %	C-TOL. = ± 5 %	C-TOL. = ± 10 %	C-TOL. = ± 5 %	C-TOL. = ± 10 %	C-TOL. = ± 5 %	
XX (SPQ)	XX (SPQ)	XX (SPQ)	XX (SPQ)	XX (SPQ)	XX (SPQ)	XX (SPQ)	XX (SPQ)	XX (SPQ)	XX (SPQ)	XX (SPQ)		
U _{RAC} = 220 V; PITCH = 5.08 mm ± 0.30 mm; d _t = 0.50 mm ± 0.05 mm												
630	0.0010	3.5 x 8.0 x 7.2	0.35	GB... (1500)	GC... (1500)	GE... (2000)	GF... (2000)	GH... (1000)	GI... (1000)	GL... (1500)	GM... (1500)	102
	0.0012											122
	0.0015											152
	0.0018											182
	0.0020											202
	0.0022											222
	0.0024											242
	0.0027											272
	0.0033											332
	0.0039											392
	0.0047	472										
	0.0056	562										
	0.0068	682										
	0.0082	822										
	0.010	103										
	0.012	4.5 x 9.0 x 7.2	0.45	GB... (1000)	GC... (1000)	GE... (2000)	GF... (2000)	GH... (1000)	GI... (1000)	GL... (1000)	GM... (1000)	123
	0.015											153
	0.018	6.0 x 11.0 x 7.2	0.65	GB... (750)	GC... (750)	GE... (2000)	GF... (2000)	GH... (1000)	GI... (1000)	GL... (1000)	GM... (1000)	183
0.022	223											
0.027	273											
0.033	333											

Notes

- SPQ = Standard Packing Quantity
- ⁽¹⁾ Weight for short lead product only

MOUNTING

Normal Use

The capacitors are designed for mounting on printed-circuit boards. The capacitors packed in bandoliers are designed for mounting in printed-circuit boards by means of automatic insertion machines.

For detailed tape specifications refer to packaging information: www.vishay.com/doc?28139 or end of catalog.

Specific Method of Mounting to Withstand Vibration and Shock

In order to withstand vibration and shock tests, it must be ensured that stand-off pips are in good contact with the printed-circuit board:

- For pitches ≤ 15 mm capacitors shall be mechanically fixed by the leads
- For larger pitches the capacitors shall be mounted in the same way and the body clamped

Space Requirements on Printed Circuit Board

The maximum space for length ($l_{max.}$), width ($w_{max.}$) and height ($h_{max.}$) of film capacitors to take in account on the printed circuit board is shown in the drawings.

- For products with pitch ≤ 15 mm, $\Delta w = \Delta l = 0.3$ mm; $\Delta h = 0.1$ mm

Eccentricity defined as in drawing. The maximum eccentricity is smaller than or equal to the lead diameter of the product concerned.

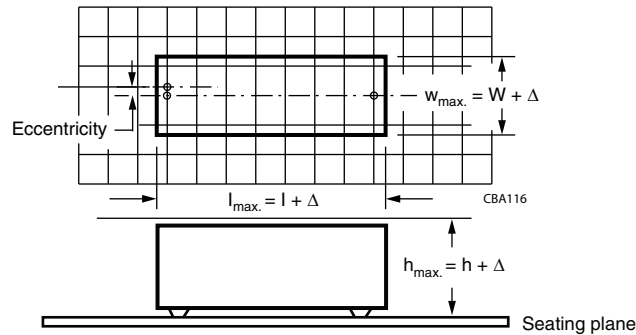

SOLDERING CONDITIONS

For general soldering conditions and wave soldering profile, we refer to the application note: "Soldering Guidelines for Film Capacitors": www.vishay.com/doc?28171

Storage Temperature

$T_{stg} = -25$ °C to $+35$ °C with with relative humidity of maximum 75 % without condensation

Ratings and Characteristics Reference Conditions

Unless otherwise specified, all electrical values apply to an ambient temperature of 23 °C ± 1 °C, an atmospheric pressure of 86 kPa to 106 kPa and a relative humidity of 50 % ± 2 %.

For reference testing, a conditioning period shall be applied over 96 h ± 4 h by heating the products in a circulating air oven at the rated temperature and a relative humidity not exceeding 20 %.

CHARACTERISTICS

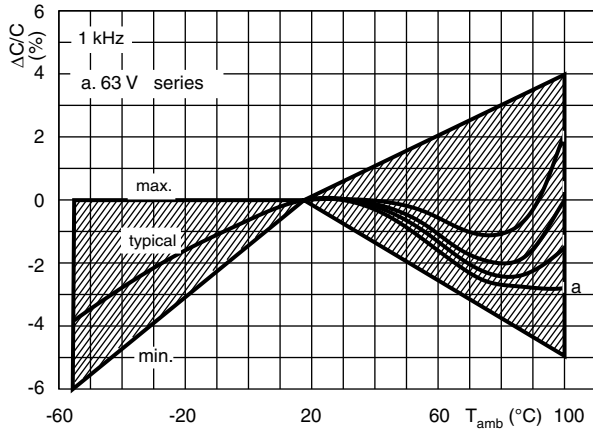

Capacitance as a function of ambient temperature (typical curve) for voltage 63 V

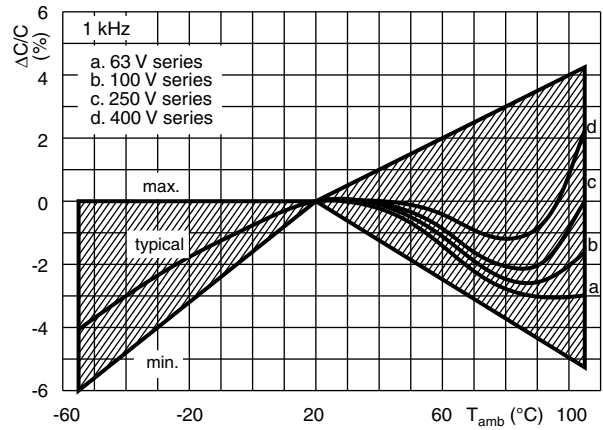

Capacitance as a function of ambient temperature (typical curve) for voltages > 63 V

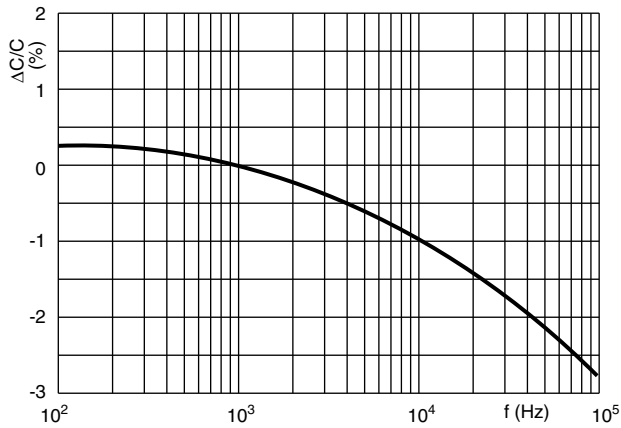

Capacitance as a function of frequency (typical curve)

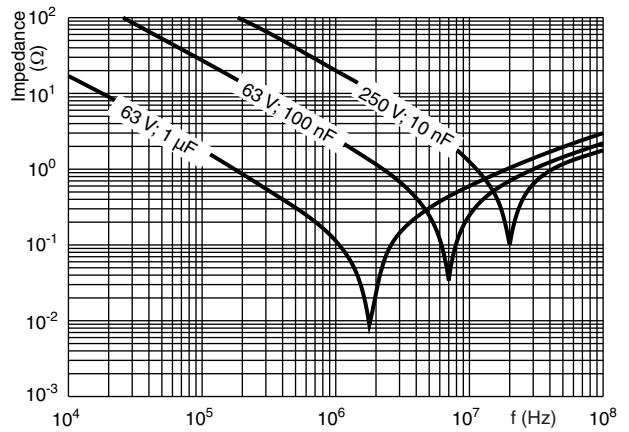

Impedance as a function of frequency

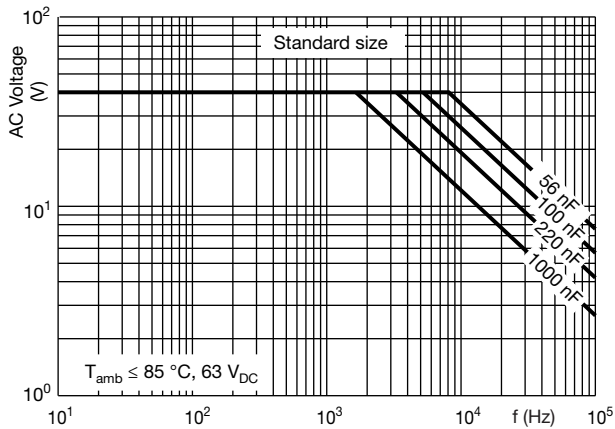

Max. AC voltage as a function of frequency

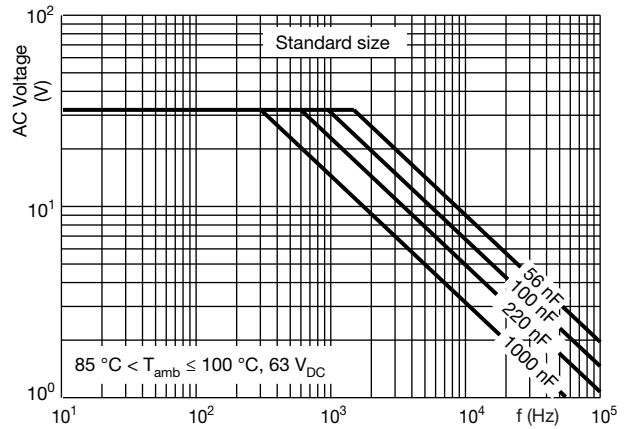

Max. AC voltage as a function of frequency



CHARACTERISTICS

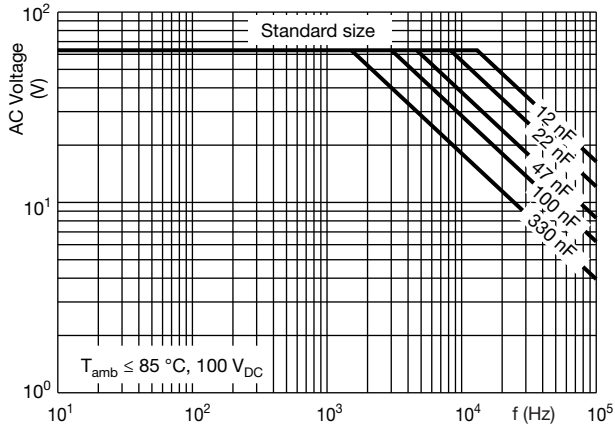

Max. AC voltage as a function of frequency

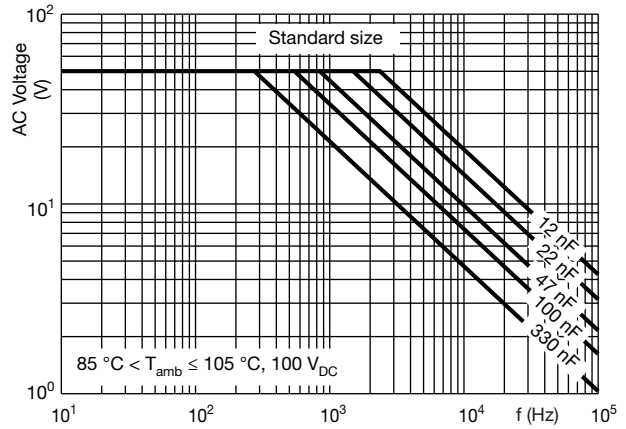

Max. AC voltage as a function of frequency

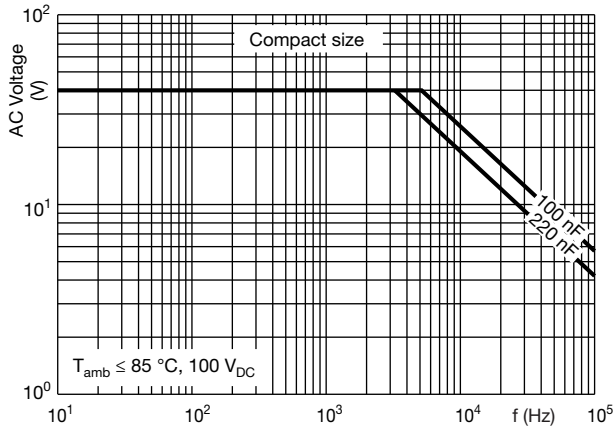

Max. AC voltage as a function of frequency

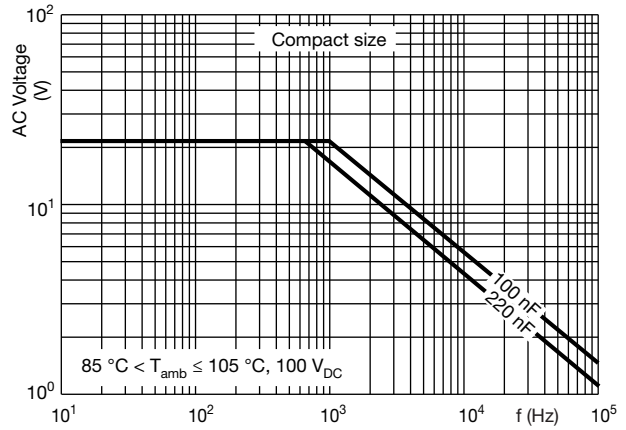

Max. AC voltage as a function of frequency

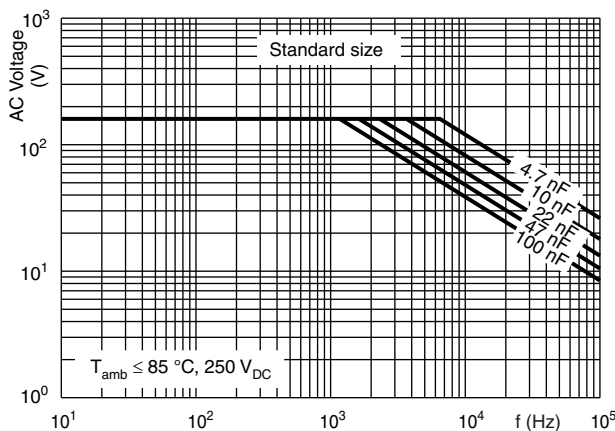

Max. AC voltage as a function of frequency

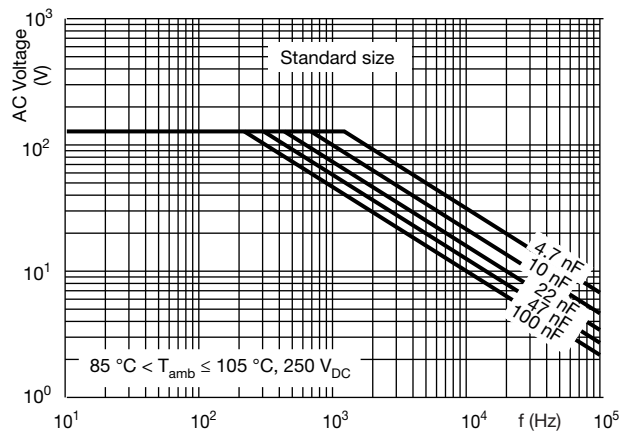

Max. AC voltage as a function of frequency



CHARACTERISTICS

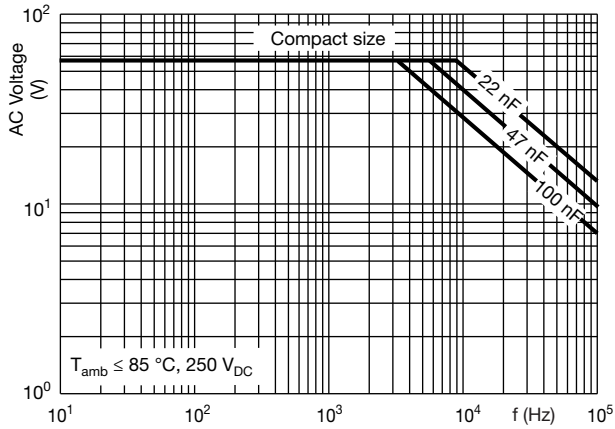

Max. AC voltage as a function of frequency

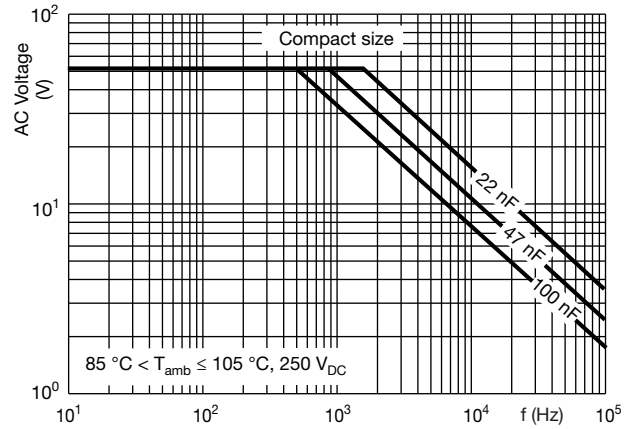

Max. AC voltage as a function of frequency

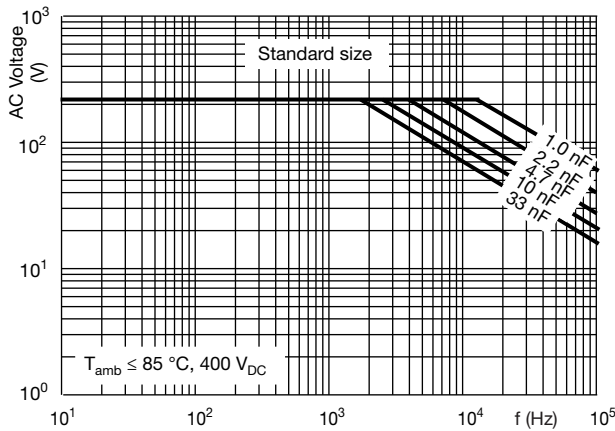

Max. AC voltage as a function of frequency

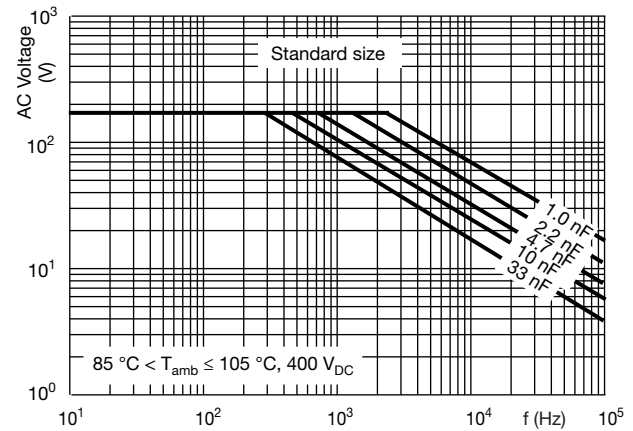

Max. AC voltage as a function of frequency

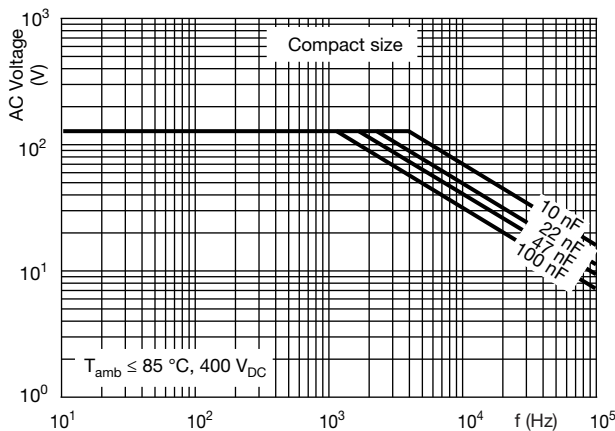

Max. AC voltage as a function of frequency

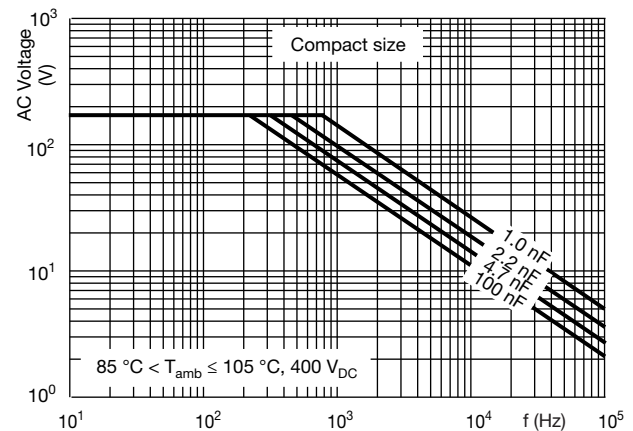

Max. AC voltage as a function of frequency



CHARACTERISTICS

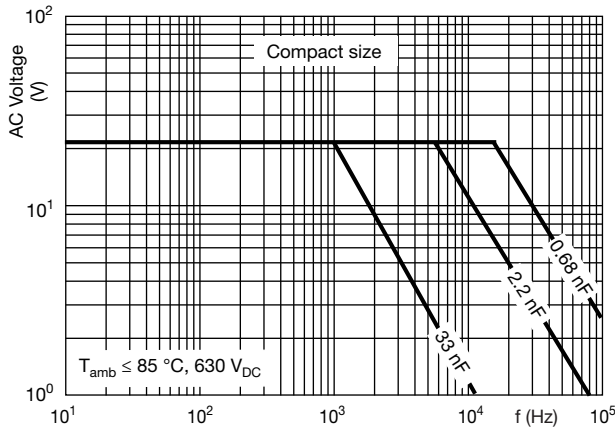

Max. AC voltage as a function of frequency

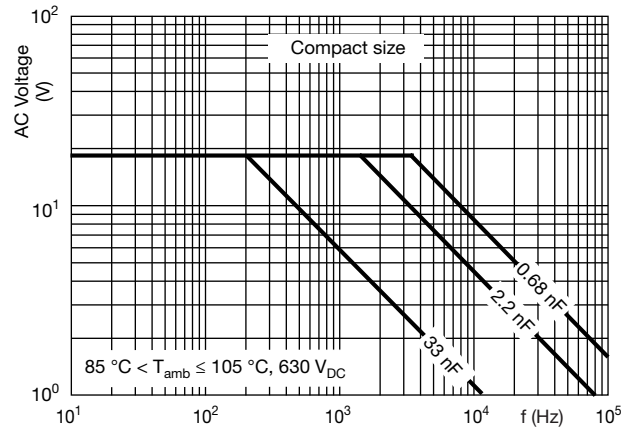

Max. AC voltage as a function of frequency

Maximum RMS current (sinewave) as a function of frequency

The maximum RMS current is defined by $I_{AC} = \omega \times C \times U_{AC}$.

U_{AC} is the maximum AC voltage depending on the ambient temperature in the curves “Max. RMS voltage and AC current as a function of frequency”.

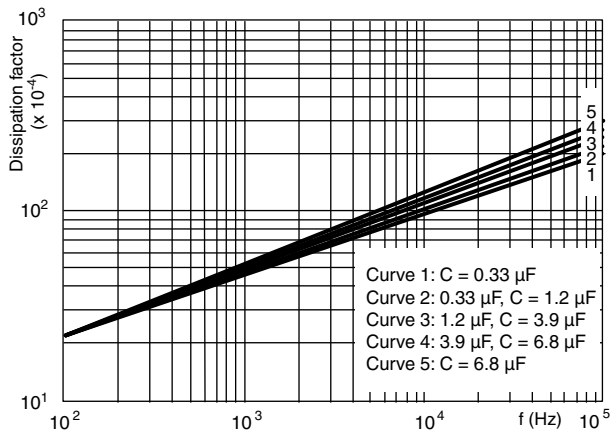

Tangent of loss angle as a function of frequency (typical curve)

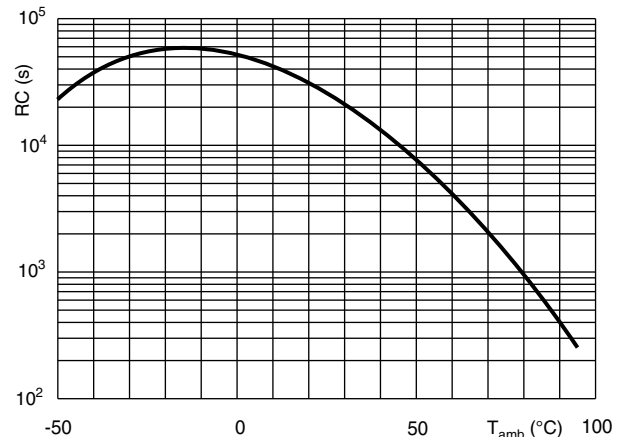

Insulation resistance as a function of the ambient temperature (typical curve)

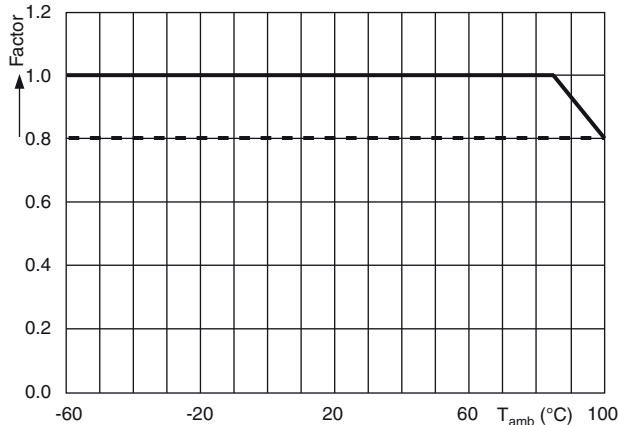

Max. DC and AC voltage as a function of frequency for voltage 63 V

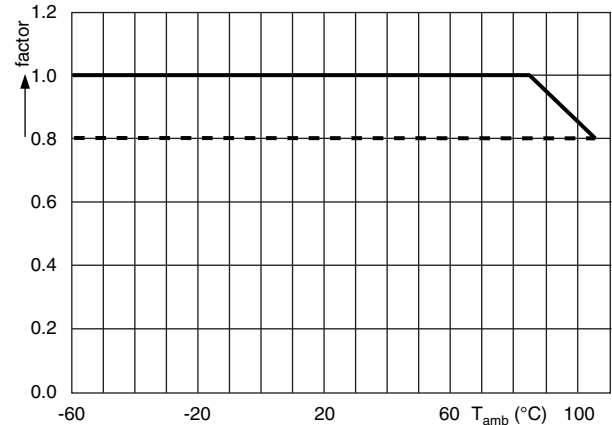

Max. DC and AC voltage as a function of frequency for voltages > 63 V

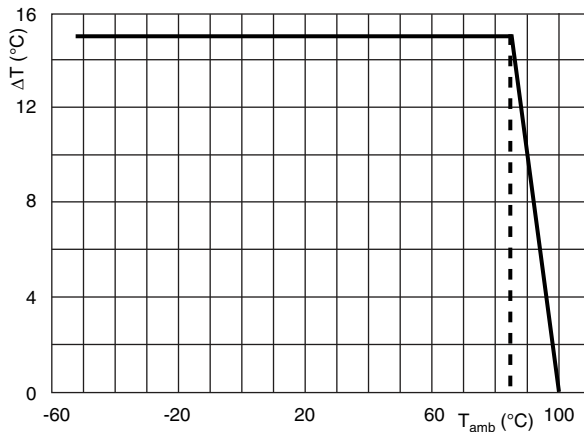
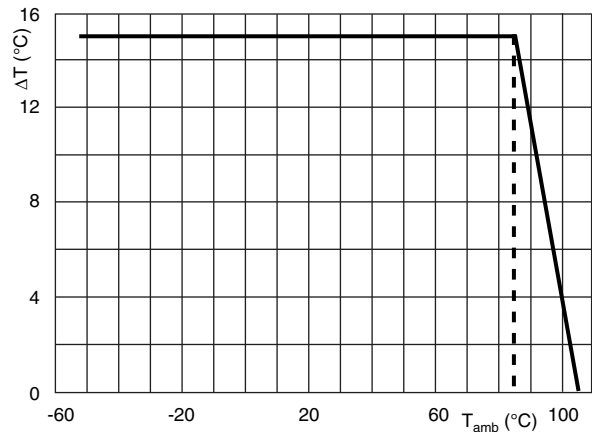
CHARACTERISTICS

 Maximum allowed component temperature rise (ΔT) as a function of the ambient temperature (T_{amb}) for voltage 63 V

 Maximum allowed component temperature rise (ΔT) as a function of the ambient temperature (T_{amb}) for voltages > 63 V

HEAT CONDUCTIVITY (G) AS A FUNCTION OF (ORIGINAL) PITCH AND CAPACITOR BODY THICKNESS IN mW/°C

W_{max} (mm)	HEAT CONDUCTIVITY (mW/°C)	
	PITCH 5 mm	
2.5	2.5	
3.5	3.0	
4.5	4.0	
6.0	5.5	

POWER DISSIPATION AND MAXIMUM COMPONENT TEMPERATURE RISE

The power dissipation must be limited in order not to exceed the maximum allowed component temperature rise as a function of the free ambient temperature.

The power dissipation can be calculated according type detail specification “HQN-384-01/101: Technical Information Film Capacitors”, www.vishay.com/doc?28147.

The component temperature rise (ΔT) can be measured (see section “Measuring the component temperature” for more details) or calculated by $\Delta T = P/G$:

- ΔT = component temperature rise (°C)
- P = power dissipation of the component (mW)
- G = heat conductivity of the component (mW/°C)

MEASURING THE COMPONENT TEMPERATURE

A thermocouple must be attached to the capacitor body as in:

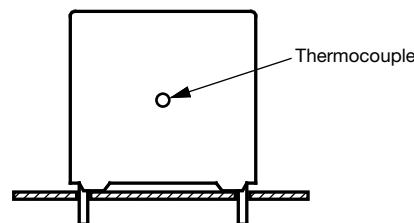

The temperature is measured in unloaded (T_{amb}) and maximum loaded condition (T_C).

The temperature rise is given by $\Delta T = T_C - T_{amb}$.

To avoid radiation or convection, the capacitor should be tested in a wind-free box.

APPLICATION NOTE AND LIMITING CONDITIONS

These capacitors are not suitable for mains applications as across-the-line capacitors without additional protection, as described hereunder. These mains applications are strictly regulated in safety standards and therefore electromagnetic interference suppression capacitors conforming the standards must be used.

For capacitors connected in parallel, normally the proof voltage and possibly the rated voltage must be reduced. For information depending of the capacitance value and the number of parallel connections contact: dc-film@vishay.com

To select the capacitor for a certain application, the following conditions must be checked:

1. The peak voltage (U_P) shall not be greater than the rated DC voltage (U_{RDC})
2. The peak-to-peak voltage (U_{P-P}) shall not be greater than $2\sqrt{2} \times U_{RAC}$ to avoid the ionization inception level
3. The voltage peak slope (dU/dt) shall not exceed the rated voltage pulse slope in an RC-circuit at rated voltage and without ringing. If the pulse voltage is lower than the rated DC voltage, the rated voltage pulse slope may be multiplied by U_{RDC} and divided by the applied voltage.

For all other pulses following equation must be fulfilled:

$$2 \times \int_0^T \left(\frac{dU}{dt} \right)^2 \times dt < U_{RDC} \times \left(\frac{dU}{dt} \right)_{rated}$$

T is the pulse duration.

4. The maximum component surface temperature rise must be lower than the limits (see figure max. allowed component temperature rise).
5. Since in circuits used at voltages over 280 V peak-to-peak the risk for an intrinsically active flammability after a capacitor breakdown (short circuit) increases, it is recommended that the power to the component is limited to 100 times the values mentioned in the table: "Heat conductivity"
6. When using these capacitors as across-the-line capacitor in the input filter for mains applications the applicant must guarantee that the following conditions are fulfilled in any case (spikes and surge voltages from the mains included).
7. For continuous use as series connection with an impedance to the mains, please refer to application note www.vishay.com/doc?28153.

VOLTAGE CONDITIONS FOR 6 ABOVE

ALLOWED VOLTAGES	$T_{amb} \leq 85^\circ C$	$85^\circ C < T_{amb} \leq 100^\circ C$ FOR 63 V
		$85^\circ C < T_{amb} \leq 105^\circ C$ FOR > 63 V
Maximum continuous RMS voltage	U_{RAC}	See "Max. AC voltage as function of temperature CBB952" per characteristics
Maximum temperature RMS-overvoltage (< 24 h)	$1.25 \times U_{RAC}$	U_{RAC}
Maximum peak voltage (V_{O-P}) (< 2 s)	$1.6 \times U_{RDC}$	$1.3 \times U_{RDC}$

EXAMPLE

$C = 330 \text{ nF}$ - 63 V used for the voltage signal shown in next drawing.

$U_{P-P} = 40 \text{ V}$; $U_P = 35 \text{ V}$; $T_1 = 100 \mu\text{s}$; $T_2 = 200 \mu\text{s}$

The ambient temperature is $35^\circ C$

Checking conditions:

1. The peak voltage $U_P = 35 \text{ V}$ is lower than 63 V_{DC}
2. The peak-to-peak voltage 40 V is lower than $2\sqrt{2} \times 40 \text{ V}_{AC} = 113 \text{ V}_{P-P}$
3. The voltage pulse slope (dU/dt) = $40 \text{ V}/100 \mu\text{s} = 0.4 \text{ V}/\mu\text{s}$
This is lower than $60 \text{ V}/\mu\text{s}$ (see specific reference data for each version)
4. The dissipated power is 16.2 mW as calculated with fourier terms
The temperature rise for $W_{max.} = 3.5 \text{ mm}$ and pitch = 5 mm will be $16.2 \text{ mW}/3.0 \text{ mW}/^\circ C = 5.4^\circ C$
This is lower than $15^\circ C$ temperature rise at $35^\circ C$, according figure max. allowed component temperature rise
5. Not applicable
6. Not applicable
7. Not applicable

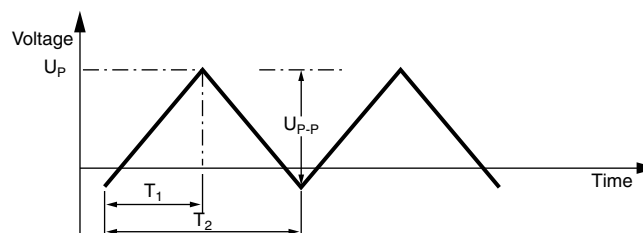
Voltage Signal



INSPECTION REQUIREMENTS

General Notes

Sub-clause numbers of tests and performance requirements refer to the "Sectional Specification, Publication IEC 60384-2 and Specific Reference Data".

GROUP C INSPECTION REQUIREMENTS		
SUB-CLAUSE NUMBER AND TEST	CONDITIONS	PERFORMANCE REQUIREMENTS
SUB-GROUP C1A PART OF SAMPLE OF SUB-GROUP C1		
4.1 Dimensions (detail)		As specified in chapters "MKT 370 General Data" of this specification
4.3.1 Initial measurements	Capacitance Tangent of loss angle: for C ≤ 470 nF at 100 kHz or for C > 470 nF at 10 kHz	
4.3 Robustness of terminations	Tensile and bending	No visible damage
4.4 Resistance to soldering heat	Method: 1A Solder bath: 280 °C ± 5 °C Duration: 10 s	
4.14 Component solvent resistance	Isopropylalcohol at room temperature Method: 2 Immersion time: 5 min ± 0.5 min Recovery time: min. 1 h, max. 2 h	
4.4.2 Final measurements	Visual examination Capacitance Tangent of loss angle	No visible damage Legible marking ΔC/C ≤ 2 % of the value measured initially Increase of tan δ ≤ 0.005 for: C ≤ 100 nF or ≤ 0.010 for: 100 nF < C ≤ 220 nF or ≤ 0.015 for: 220 nF < C ≤ 470 nF and ≤ 0.003 for: C > 470 nF Compared to values measured in 4.3.1
SUB-GROUP C1B OTHER PART OF SAMPLE OF SUB-GROUP C1		
4.6.1 Initial measurements	Capacitance Tangent of loss angle: for C ≤ 470 nF at 100 kHz or for C > 470 nF at 10 kHz	
4.6 Rapid change of temperature	θA = -55 °C θB = +100 °C for rated voltage 63 V +105 °C for rated voltage > 63 V 5 cycles Duration t = 30 min	
4.7 Vibration	Visual examination Mounting: see section "Mounting" of this specification Procedure B4 Frequency range: 10 Hz to 55 Hz Amplitude: 0.75 mm or Acceleration 98 m/s ² (whichever is less severe) Total duration 6 h	No visible damage
4.7.2 Final inspection	Visual examination	No visible damage



GROUP C INSPECTION REQUIREMENTS		
SUB-CLAUSE NUMBER AND TEST	CONDITIONS	PERFORMANCE REQUIREMENTS
SUB-GROUP C1B OTHER PART OF SAMPLE OF SUB-GROUP C1		
4.9 Shock	Mounting: see section "Mounting" of this specification Pulse shape: half sine Acceleration: 490 m/s ² Duration of pulse: 11 ms	
4.9.3 Final measurements	Visual examination Capacitance Tangent of loss angle Insulation resistance	No visible damage $ \Delta C/C \leq 3\%$ of the value measured in 4.6.1 Increase of $\tan \delta$ ≤ 0.010 for: $C \leq 220$ nF or ≤ 0.015 for: 220 nF < $C \leq 470$ nF and ≤ 0.003 for: $C > 470$ nF Compared to values measured in 4.6.1 As specified in section "Specific Reference Data 370" of this specification
SUB-GROUP C1 COMBINED SAMPLE OF SPECIMENS OF SUB-GROUPS C1A AND C1B		
4.10 Climatic sequence		
4.10.2 Dry heat	Temperature: +100 °C for rated voltage 63 V +105 °C for rated voltage > 63 V Duration: 16 h	
4.10.3 Damp heat cyclic Test Db, first cycle		
4.10.4 Cold	Temperature: -55 °C Duration: 2 h	
4.10.6 Damp heat cyclic Test Db, remaining cycles	Voltage proof = U_{RDC} for 1 min within 15 min after removal from testchamber	No breakdown of flash-over
4.10.6.2 Final measurements	Visual examination Capacitance Tangent of loss angle Insulation resistance	No visible damage Legible marking $ \Delta C/C \leq 5\%$ of the value measured in 4.4.2 or 4.9.3 Increase of $\tan \delta$ ≤ 0.010 for: $C \leq 220$ nF or ≤ 0.015 for: 220 nF < $C \leq 470$ nF and ≤ 0.005 for: $C > 470$ nF Compared to values measured in 4.3.1 or 4.6.1 $\geq 50\%$ of values specified in section "Specific Reference Data 370" of this specification
SUB-GROUP C2		
4.11 Damp heat steady state	56 days, 40 °C, 90 % to 95 % RH	
4.11.1 Initial measurements	Capacitance Tangent of loss angle at 1 kHz	



GROUP C INSPECTION REQUIREMENTS		
SUB-CLAUSE NUMBER AND TEST	CONDITIONS	PERFORMANCE REQUIREMENTS
SUB-GROUP C2		
4.11.3 Final measurements	Voltage proof = U_{RDC} for 1 min within 15 min after removal from testchamber Visual examination Capacitance Tangent of loss angle Insulation resistance	No breakdown of flash-over No visible damage Legible marking $ \Delta C/C \leq 5\%$ of the value measured in 4.11.1. Increase of $\tan \delta \leq 0.005$ Compared to values measured in 4.11.1 $\geq 50\%$ of values specified in section "Specific Reference Data 370" of this specification
SUB-GROUP C3		
4.12 Endurance	Duration: 2000 h $1.25 \times U_{RDC}$ at 85 °C $0.8 \times 1.25 U_{RDC}$ at +100 °C for rated voltage 63 V $0.8 \times 1.25 U_{RDC}$ at +105 °C for rated voltage > 63 V	
4.12.1 Initial measurements	Capacitance Tangent of loss angle: For $C \leq 470$ nF at 100 kHz or for $C > 470$ nF at 10 kHz	
4.12.5 Final measurements	Visual examination Capacitance Tangent of loss angle Insulation resistance	No visible damage Legible marking $ \Delta C/C \leq 5\%$ compared to values measured in 4.12.1 Increase of $\tan \delta$ ≤ 0.005 for at 85 °C ≤ 0.010 for at 100 °C for: $C \leq 220$ nF or ≤ 0.015 for: 220 nF < $C \leq 470$ nF and ≤ 0.003 for: $C > 470$ nF Compared to values measured in 4.12.1 $\geq 50\%$ of values specified in section "Specific Reference Data 370" of this specification
SUB-GROUP C4		
4.13 Charge and discharge	10 000 cycles Charged to U_{RDC} Discharge resistance: $R = \frac{U_R}{C \times (2.5 \times (dU/dt)_R)}$	
4.13.1 Initial measurements	Capacitance Tangent of loss angle: For $C \leq 470$ nF at 100 kHz or for $C > 470$ nF at 10 kHz	
4.13.3 Final measurements	Capacitance Tangent of loss angle Insulation resistance	$ \Delta C/C \leq 3\%$ compared to values measured in 4.13.1 Increase of $\tan \delta$ ≤ 0.005 for: $C \leq 100$ nF or ≤ 0.010 for: 100 nF < $C \leq 220$ nF or ≤ 0.015 for: 220 nF < $C \leq 470$ nF and ≤ 0.003 for: $C > 470$ nF Compared to values measured in 4.13.1 $\geq 50\%$ of values specified in section "Specific Reference Data 370" of this specification



Disclaimer

ALL PRODUCT, PRODUCT SPECIFICATIONS AND DATA ARE SUBJECT TO CHANGE WITHOUT NOTICE TO IMPROVE RELIABILITY, FUNCTION OR DESIGN OR OTHERWISE.

Vishay Intertechnology, Inc., its affiliates, agents, and employees, and all persons acting on its or their behalf (collectively, "Vishay"), disclaim any and all liability for any errors, inaccuracies or incompleteness contained in any datasheet or in any other disclosure relating to any product.

Vishay makes no warranty, representation or guarantee regarding the suitability of the products for any particular purpose or the continuing production of any product. To the maximum extent permitted by applicable law, Vishay disclaims (i) any and all liability arising out of the application or use of any product, (ii) any and all liability, including without limitation special, consequential or incidental damages, and (iii) any and all implied warranties, including warranties of fitness for particular purpose, non-infringement and merchantability.

Statements regarding the suitability of products for certain types of applications are based on Vishay's knowledge of typical requirements that are often placed on Vishay products in generic applications. Such statements are not binding statements about the suitability of products for a particular application. It is the customer's responsibility to validate that a particular product with the properties described in the product specification is suitable for use in a particular application. Parameters provided in datasheets and / or specifications may vary in different applications and performance may vary over time. All operating parameters, including typical parameters, must be validated for each customer application by the customer's technical experts. Product specifications do not expand or otherwise modify Vishay's terms and conditions of purchase, including but not limited to the warranty expressed therein.

Hyperlinks included in this datasheet may direct users to third-party websites. These links are provided as a convenience and for informational purposes only. Inclusion of these hyperlinks does not constitute an endorsement or an approval by Vishay of any of the products, services or opinions of the corporation, organization or individual associated with the third-party website. Vishay disclaims any and all liability and bears no responsibility for the accuracy, legality or content of the third-party website or for that of subsequent links.

Except as expressly indicated in writing, Vishay products are not designed for use in medical, life-saving, or life-sustaining applications or for any other application in which the failure of the Vishay product could result in personal injury or death. Customers using or selling Vishay products not expressly indicated for use in such applications do so at their own risk. Please contact authorized Vishay personnel to obtain written terms and conditions regarding products designed for such applications.

No license, express or implied, by estoppel or otherwise, to any intellectual property rights is granted by this document or by any conduct of Vishay. Product names and markings noted herein may be trademarks of their respective owners.