

Features

- ◆ Ultra small package: 0.6x0.3x0.3mm
- ◆ Ultra low capacitance: 8pF typical
- ◆ Ultra low leakage: nA level
- ◆ Low operating voltage: 7V
- ◆ Low clamping voltage
- ◆ 2-pin leadless package
- ◆ Complies with following standards:
 - IEC 61000-4-2 (ESD) immunity test
 - Air discharge: $\pm 30\text{kV}$
 - Contact discharge: $\pm 30\text{kV}$
 - IEC61000-4-5 (Lightning) 11A (8/20 μs)
- ◆ RoHS Compliant

Description

The ESDK7B0U0D1 is a bi-directional TVS diode, utilizing leading monolithic silicon technology to provide fast response time and low ESD clamping voltage, making this device an ideal solution for protecting voltage sensitive data and power line. The ESDK7B0U0D1 complies with the IEC 61000-4-2 (ESD) standard with $\pm 15\text{ kV}$ air and $\pm 8\text{ kV}$ contact discharge. It is assembled into an ultra-small 0.6x0.3x0.3mm lead-free 0201 package. The small size and high ESD surge protection make ESDK7B0U0D1 an ideal choice to protect cell phone, digital cameras, audio players and many other portable applications.

Circuit Diagram

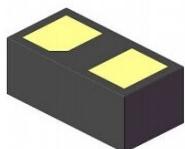
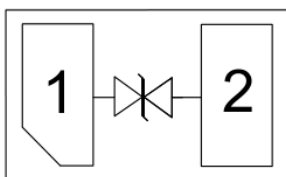

Applications

- ◆ Cellular Handsets and Accessories
- ◆ Personal Digital Assistants
- ◆ Notebooks and Handhelds
- ◆ Portable Instrumentation
- ◆ Digital Cameras
- ◆ Peripherals
- ◆ Audio Players
- ◆ Keypads, Side Keys, LCD Displays

Absolute Maximum Ratings : ($T_C=25^{\circ}\text{C}$ unless otherwise noted)

Parameter	Symbol	Value	Unit
Peak Pulse Power (8/20 μs)	Ppk	220	W
Peak Pulse Current (8/20 μs)	IPP	11	A
ESD per IEC 61000-4-2 (Air)	VESD	± 30	kV
ESD per IEC 61000-4-2 (Contact)		± 30	
Operating Temperature Range	TJ	-55 to +125	$^{\circ}\text{C}$
Storage Temperature Range	Tstg	-55 to +150	$^{\circ}\text{C}$

Electrical Characteristics : ($T_C=25^{\circ}\text{C}$ unless otherwise noted)

Parameter	Symbol	Test Condition	Min	Typ	Max	Unit
Reverse Working Voltage	V_{RWM}				7.0	V
Breakdown Voltage	V_{BR}	$I_T = 1\text{mA}$	8.0	8.8	10.0	V
Reverse Leakage Current	I_R	$V_{RWM} = 7.0\text{V}$			0.1	μA
Clamping Voltage	V_C	$I_{PP} = 1\text{A}$ (8 / 20 μs pulse)			13.0	V
Clamping Voltage	V_C	$I_{PP} = 11\text{A}$ (8 / 20 μs pulse)			20.0	V
Junction Capacitance	C_J	$V_R = 0\text{V}$, $f = 1\text{MHz}$		8	10	pF

Portion Electronics Parameter

Symbol	Parameter
V_{RWM}	Peak Reverse Working Voltage
I_R	Reverse Leakage Current @ V_{RWM}
V_{BR}	Breakdown Voltage @ I_T
I_T	Test Current
I_{PP}	Maximum Reverse Peak Pulse Current
V_C	Clamping Voltage @ I_{PP}

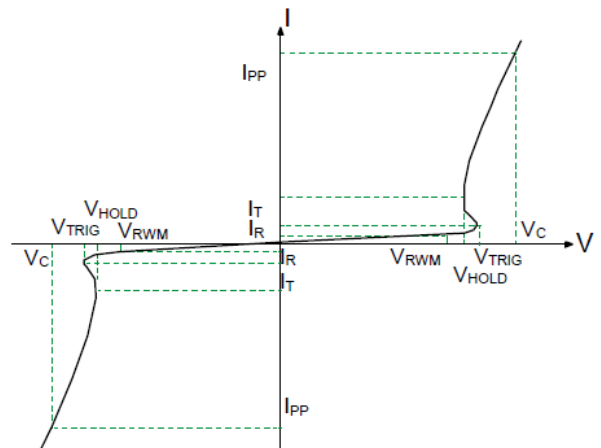

Typical Characteristics: ($T_c=25^\circ\text{C}$ unless otherwise noted)

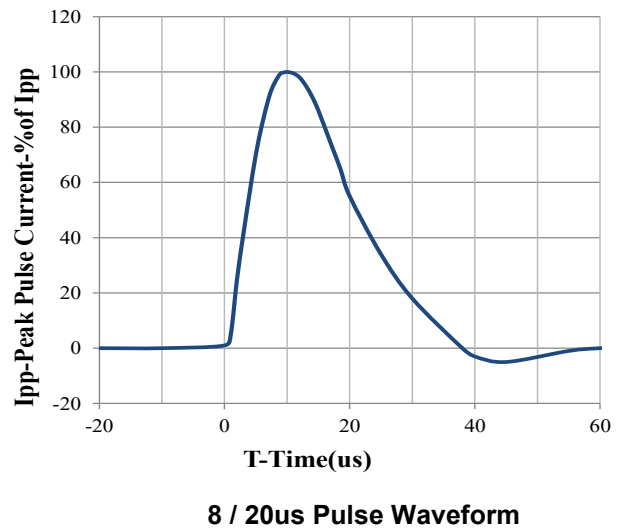
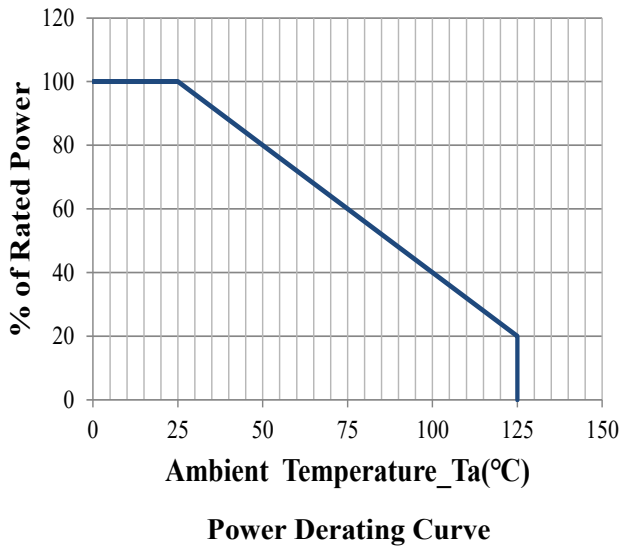
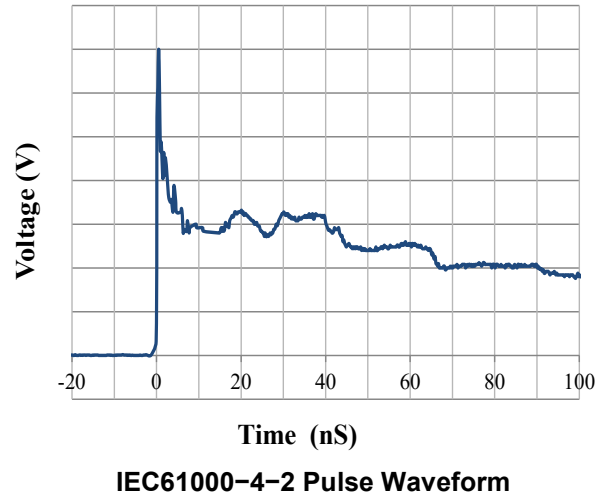
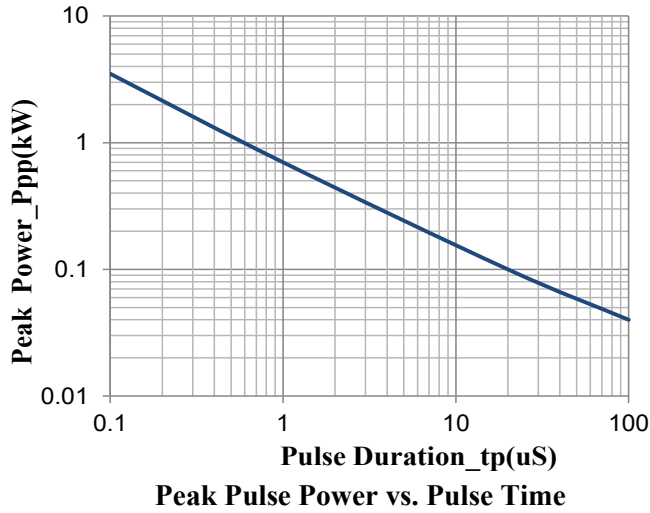

Package Dimension

DFN0603-2(0201) Package Outline

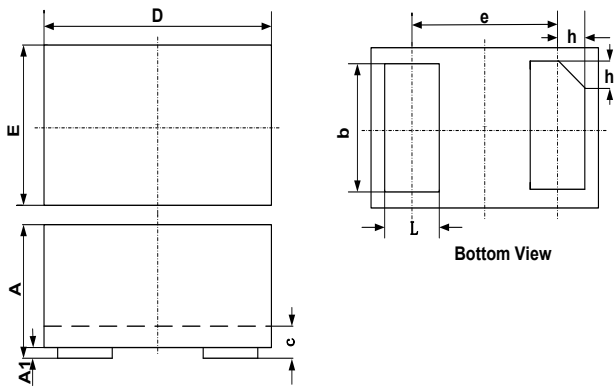

SYM	DIMENSIONS		
	MILLIMETERS		
	MIN	NOM	MAX
A	0.230		0.330
A1	0.000	0.020	0.050
b	0.215	0.245	0.275
c	0.120	0.150	0.180
D	0.550	0.600	0.650
e	0.355 BSC		
E	0.250	0.300	0.350
L	0.160	0.190	0.220
h	0.079 BSC		

Suggested Land Pattern

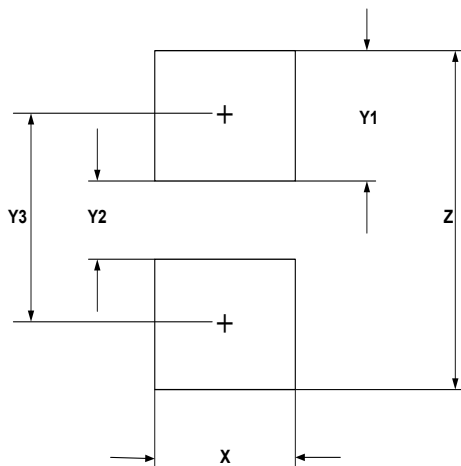

SYM	DIMENSIONS	
	MILLIMETERS	INCHES
X	0.30	0.012
Y1	0.25	0.010
Y2	0.15	0.006
Y3	0.40	0.016
Z	0.65	0.026

Soldering Parameters

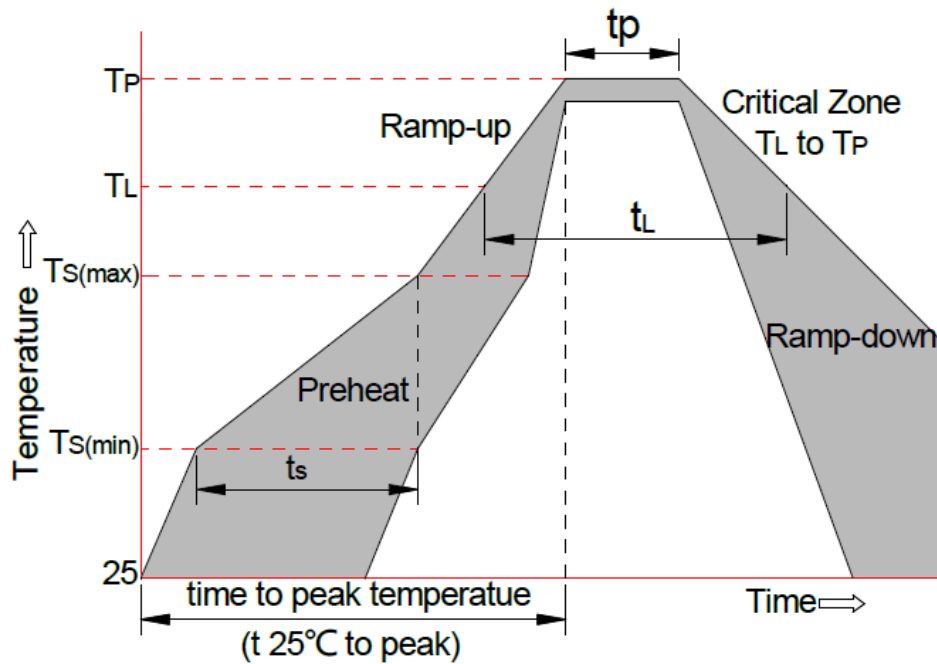

Reflow Condition		Pb-Free Assembly
Pre-heat	-Temperature Min (T_s (min))	+150°C
	-Temperature Max (T_s (max))	+200°C
	-Time (Min to Max) (t_s)	60-180 secs
Average ramp up rate(Liquid us Temp (T_L) to peak)		3°C/sec. Max
T_s (max) to T_L -Ramp-up Rate		3°C/sec. Max
Reflow	-Temperature (T_L) (Liquid us)	+217°C
	-Temperature (t_L)	60-150 secs
Peak Temp (T_p)		+260(+0/-5)°C
Time within 5°C of actual Peak Temp (t_p)		30 secs. Max
Ramp-down Rate		6 °C/secs. Max
xTime 25°C to Peak Temp (T_P)		8 min. Max
Do not exceed		+260°C