

Features

- ◆ Ultra small package: 1.0x0.6x0.5mm
- ◆ Ultra low leakage: nA level
- ◆ Low operating voltage: 7.0V
- ◆ Low clamping voltage
- ◆ 2-pin leadless package
- ◆ Complies with following standards:
 - IEC 61000-4-2 (ESD) immunity test
 - Air discharge: $\pm 30\text{kV}$
 - Contact discharge: $\pm 30\text{kV}$
 - IEC61000-4-5 (Lightning) 8A (8/20 μs)
- ◆ RoHS Compliant

Description

The ESDJ7U0L0D2 is a uni-directional TVS diode, utilizing leading monolithic silicon technology to provide fast response time and low ESD clamping voltage, making this device an ideal solution for protecting voltage sensitive data and power line. The ESDJ7U0L0D2 complies with the IEC 61000-4-2 (ESD) standard with $\pm 30\text{ kV}$ air and $\pm 30\text{ kV}$ contact discharge. It is assembled into an ultra-small 1.0x0.6x0.5mm lead-free 0402 package. The small size and high ESD surge protection make ESDJ7U0L0D2 an ideal choice to protect Power and many other portable applications.

Circuit Diagram



Applications

- ◆ Mobile Phones
- ◆ Battery Protection
- ◆ Power Line Protection
- ◆ Vbat pin for Mobile Devices
- ◆ Hand Held Portable Applications

Absolute Maximum Ratings : ($T_c=25^{\circ}\text{C}$ unless otherwise noted)

Parameter	Symbol	Value	Unit
Peak Pulse Power (8/20 μs)	Ppk	152	W
Peak Pulse Current (8/20 μs)	IPP	8	A
ESD per IEC 61000-4-2 (Air)	VESD	± 30	kV
ESD per IEC 61000-4-2 (Contact)		± 30	
Operating Temperature Range	TJ	-55 to +125	$^{\circ}\text{C}$
Storage Temperature Range	Tstg	-55 to +150	$^{\circ}\text{C}$

Electrical Characteristics : ($T_c=25^{\circ}\text{C}$ unless otherwise noted)

Parameter	Symbol	Test Condition	Min	Typ	Max	Unit
Reverse Working Voltage	V_{RWM}				7.0	V
Breakdown Voltage	V_{BR}	$I_T = 1\text{mA}$	8.0	9.2	10.0	V
Reverse Leakage Current	I_R	$V_{RWM} = 7.0\text{V}$			0.2	μA
Clamping Voltage	V_C	$I_{PP} = 1\text{A}$ (8 / 20 μs pulse)			12.0	V
Clamping Voltage	V_C	$I_{PP} = 8\text{A}$ (8 / 20 μs pulse)			19.0	V
Junction Capacitance	C_J	$V_R = 0\text{V}$, $f = 1\text{MHz}$		45	55	pF

Portion Electronics Parameter

Symbol	Parameter
V_{RWM}	Peak Reverse Working Voltage
I_R	Reverse Leakage Current @ V_{RWM}
V_{BR}	Breakdown Voltage @ I_T
I_T	Test Current
I_{PP}	Maximum Reverse Peak Pulse Current
V_C	Clamping Voltage @ I_{PP}

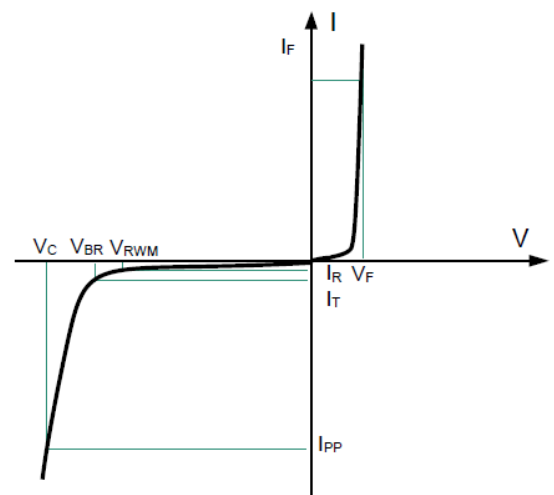

Typical Characteristics: ($T_C=25^\circ\text{C}$ unless otherwise noted)

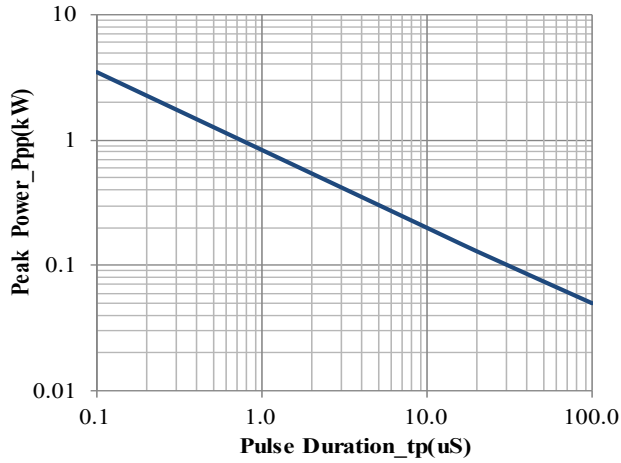

Peak Pulse Power vs. Pulse Time

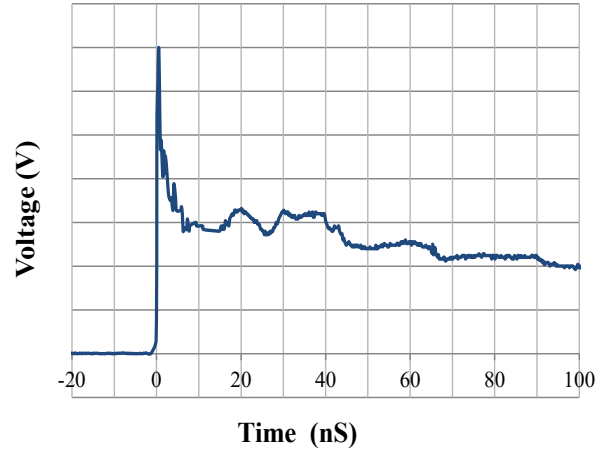

IEC61000-4-2 Pulse Waveform

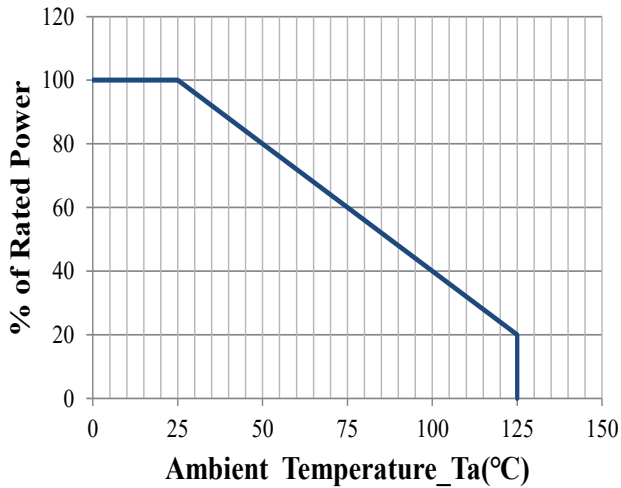

Power Derating Curve

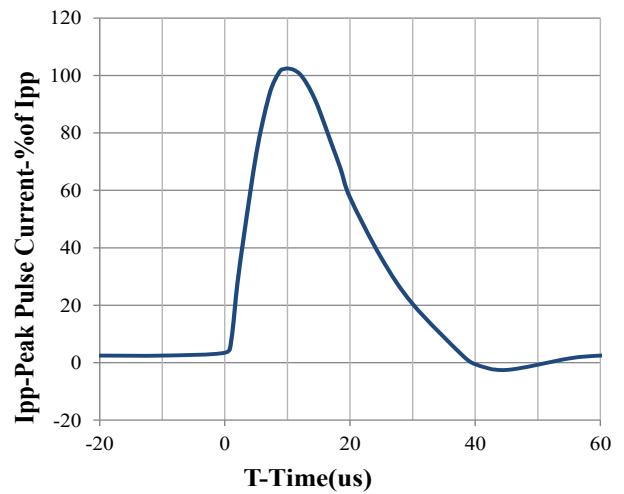

8 / 20us Pulse Waveform

Package Dimension

DFN1006-2(0402) Package Outline

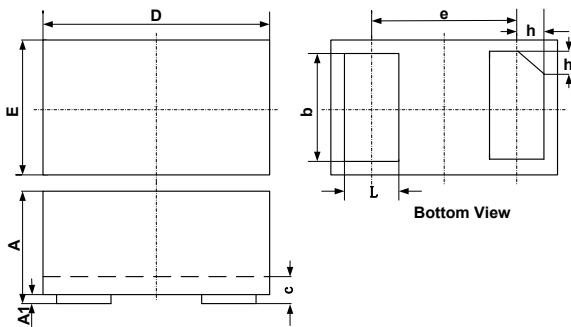

SYM	DIMENSIONS					
	MILLIMETERS			INCHES		
	MIN	NOM	MAX	MIN	NOM	MAX
A	0.45	0.50	0.55	0.018	0.020	0.022
A1	0.00	0.02	0.05	0.000	0.001	0.002
b	0.45	0.50	0.55	0.018	0.020	0.022
c	0.12	0.15	0.18	0.005	0.006	0.007
D	0.95	1.00	1.05	0.037	0.039	0.041
e	0.65 BSC			0.026 BSC		
E	0.55	0.60	0.65	0.022	0.024	0.026
L	0.20	0.25	0.30	0.008	0.010	0.012
h	0.07	0.12	0.17	0.003	0.005	0.007

Suggested Land Pattern

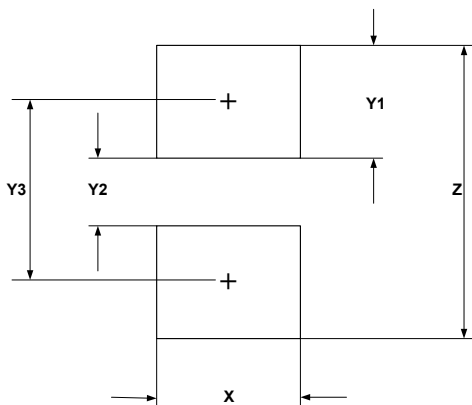

SYM	DIMENSIONS	
	MILLIMETERS	INCHES
X	0.60	0.024
Y1	0.50	0.020
Y2	0.30	0.012
Y3	0.80	0.032
Z	1.30	0.052

Soldering Parameters

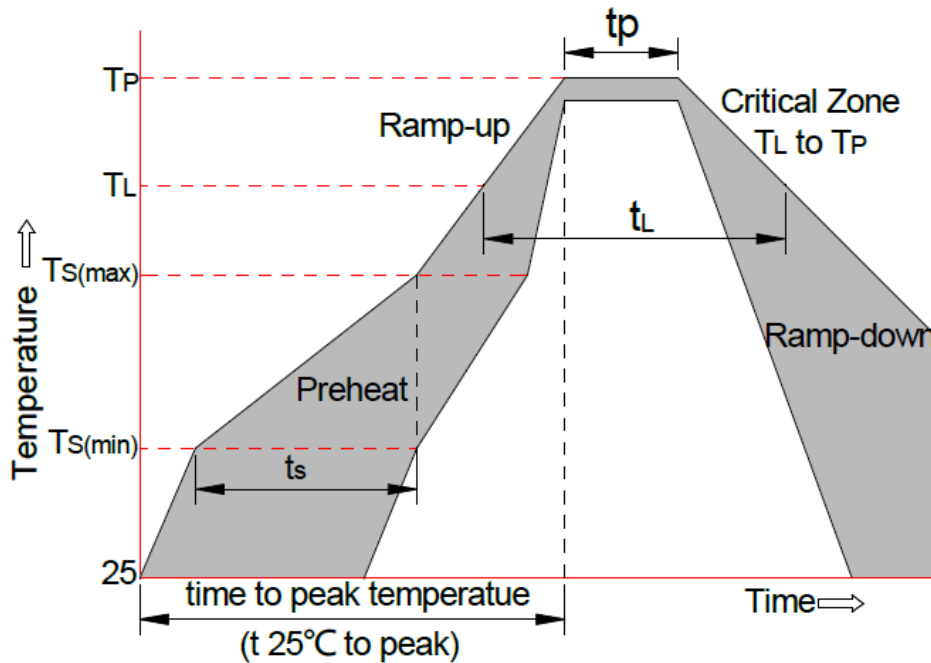

Reflow Condition		Pb-Free Assembly
Pre-heat	-Temperature Min (T_s (min))	+150°C
	-Temperature Max (T_s (max))	+200°C
	-Time (Min to Max) (t_s)	60-180 secs
Average ramp up rate(Liquid us Temp (T_L) to peak)		3°C/sec. Max
T_s (max) to T_L -Ramp-up Rate		3°C/sec. Max
Reflow	-Temperature (T_L) (Liquid us)	+217°C
	-Temperature (t_L)	60-150 secs
Peak Temp (T_p)		+260(+0/-5)°C
Time within 5°C of actual Peak Temp (t_p)		30 secs. Max
Ramp-down Rate		6 °C/secs. Max
xTime 25°C to Peak Temp (T_p)		8 min. Max
Do not exceed		+260°C