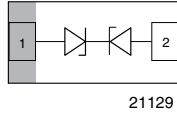




Ultra Low Capacitance Bidirectional Symmetrical (BiSy) Single Line ESD Protection Diode in DFN1006-2B



21129



MARKING (example only)



Bar = cathode marking
X = date code
YY = type code (see table below)

LINKS TO ADDITIONAL RESOURCES



FEATURES

- Ultra compact DFN1006-2B package
- Low package height < 0.5 mm
- 1-line ESD protection
- AEC-Q101 qualified available
- Working range ± 3.3 V
- Low leakage current < 0.01 μ A
- Ultra low load capacitance $C_D = 0.36$ pF typ.
- ESD immunity acc. IEC 61000-4-2
 ± 16 kV contact discharge
 ± 16 kV air discharge
- e3 - Sn
Tin plated exposed side wall of lead frame
- Soldering can be checked by standard vision inspection
- AOI = Automated Optical Inspection
- No X-ray necessary
- Lead material: Cu
- PATENT(S): www.vishay.com/patents
- Material categorization: for definitions of compliance please see www.vishay.com/doc?99912



| ORDERING INFORMATION | | | | | |
|-----------------------|--------------------------------|--|------------|-----------------------------|-------------------------|
| PART NUMBER (EXAMPLE) | ENVIRONMENTAL AND QUALITY CODE | | | PACKAGING CODE | ORDERING CODE (EXAMPLE) |
| | AEC-Q101 QUALIFIED | RoHS-COMPLIANT + LEAD (Pb)-FREE TERMINATIONS | TIN PLATED | 10K PER 7" REEL (8 mm TAPE) | |
| | | GREEN | | 10K = MOQ | |
| VBUS03N1-DD1 | - | G | 3 | -08 | VBUS03N1-DD1-G3-08 |
| VBUS03N1-DD1 | H | G | 3 | -08 | VBUS03N1-DD1HG3-08 |

| PACKAGE DATA | | | | |
|--------------|--------------|-----------|---------|------------------------------|
| DEVICE NAME | PACKAGE NAME | TYPE CODE | WEIGHT | SOLDERING CONDITIONS |
| VBUS03N1-DD1 | DFN1006-2B | 3B | 0.83 mg | Peak temperature max. 260 °C |

| ABSOLUTE MAXIMUM RATINGS | | | | |
|--------------------------|---|-----------|-------------|------|
| PARAMETER | TEST CONDITIONS | SYMBOL | VALUE | UNIT |
| Peak pulse current | Acc. IEC 61000-4-5, 8/20 μ s/single shot | I_{PPM} | 4 | A |
| Peak pulse power | Pin 1 to pin 2 Acc. IEC 61000-4-5; $t_p = 8/20$ μ s; single shot | P_{PP} | 90 | W |
| ESD immunity | Contact discharge acc. IEC 61000-4-2; 10 pulses | V_{ESD} | ± 16 | kV |
| | Air discharge acc. IEC 61000-4-2; 10 pulses | | ± 16 | |
| Operating temperature | Junction temperature | T_J | -55 to +150 | °C |
| Storage temperature | | T_{stg} | -55 to +150 | °C |

PATENT(S): www.vishay.com/patents

This Vishay product is protected by one or more United States and international patents.

ESD PROTECTION FOR HIGH-SPEED SIGNAL OR DATA LINES

The VBUS03N1-DD1 is a Bidirectional and Symmetrical (BiSy) ESD protection device which clamps positive and negative overvoltage transients to ground. Connected between the signal or data line and the ground the VBUS03N1-DD1 offers a high isolation (low leakage current, low capacitance) within the specified working range. Due to the short leads and small package size of the tiny DFN1006 package the line inductance is very low, so that fast transients like an ESD strike can be clamped with minimal over- or undershoots. Due to the very low capacitance the VBUS03N1-DD1 can be used for high speed data ports like HDMI, USB 3.0 or Thunderbolt.

| ELECTRICAL CHARACTERISTICS ($T_{amb} = 25\text{ }^{\circ}\text{C}$, unless otherwise specified) | | | | | | |
|--|---|---------------|------|------|------|---------------|
| PARAMETER | TEST CONDITIONS/REMARKS | SYMBOL | MIN. | TYP. | MAX. | UNIT |
| Protection paths | Number of lines which can be protected | $N_{channel}$ | - | - | 1 | lines |
| Reverse stand-off voltage | Max. reverse working voltage | V_{RWM} | - | - | 3.3 | V |
| Reverse voltage | at $I_R = 0.1\text{ }\mu\text{A}$ | V_R | 3.3 | - | - | V |
| Reverse current | at $V_{RWM} = 3.3\text{ V}$ | I_R | - | - | 0.1 | μA |
| Reverse breakdown voltage | at $I_R = 1\text{ mA}$ | V_{BR} | 7 | 8.5 | 10 | V |
| Reverse clamping voltage | at $I_{PP} = 1\text{ A}$ | V_C | - | 11.5 | 13 | V |
| | at $I_{PP} = I_{PPM} = 4\text{ A}$ | V_C | - | 18 | 21 | V |
| Capacitance | at $V_R = 0\text{ V}$; $f = 1\text{ MHz}$ | C_D | - | 0.36 | 0.4 | pF |
| | at $V_R = 3.3\text{ V}$; $f = 1\text{ MHz}$ | C_D | - | 0.36 | - | pF |
| Clamping voltage | Transmission Line Pulse (TLP); $t_p = 100\text{ ns}$ $I_{TLP} = 8\text{ A}$ | V_{C-TLP} | - | 22 | - | V |
| | Transmission Line Pulse (TLP); $t_p = 100\text{ ns}$ $I_{TLP} = 16\text{ A}$ | | - | 33 | - | |
| Dynamic resistance | Transmission Line Pulse (TLP); $t_p = 100\text{ ns}$ | R_{DYN} | - | 1.4 | - | Ω |

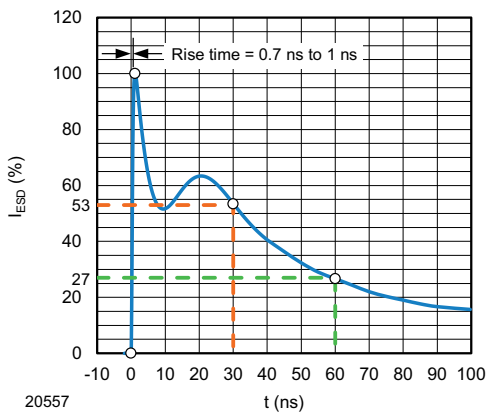
TYPICAL CHARACTERISTICS ($T_{amb} = 25\text{ }^{\circ}\text{C}$, unless otherwise specified)


Fig. 1 - ESD Discharge Current Wave Form
acc. IEC 61000-4-2 (330 Ω /150 pF)

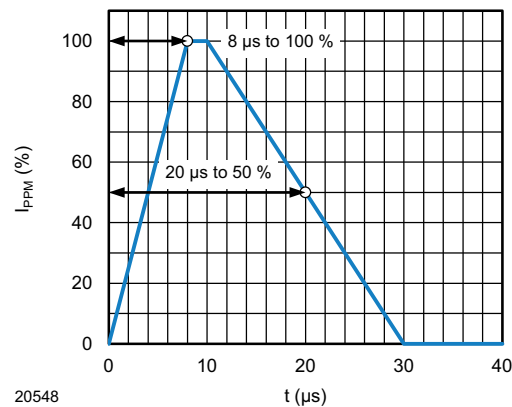
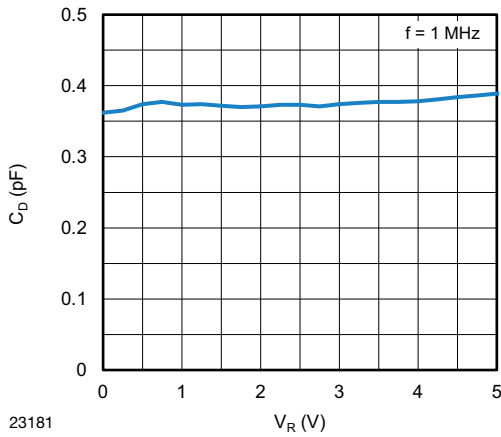
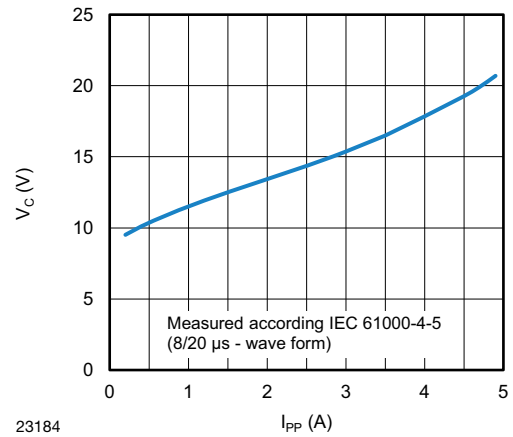


Fig. 2 - 8/20 μs Peak Pulse Current Wave Form
acc. IEC 61000-4-5



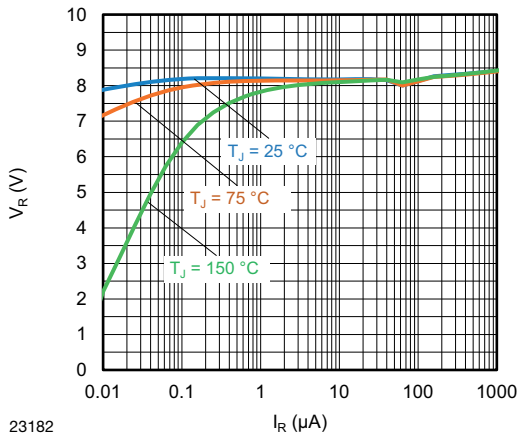
23181

Fig. 3 - Typical Capacitance vs. Reverse Voltage



23184

Fig. 6 - Typical Peak Clamping Voltage vs. Peak Pulse Current



23182

Fig. 4 - Typical Reverse Voltage vs. Reverse Current

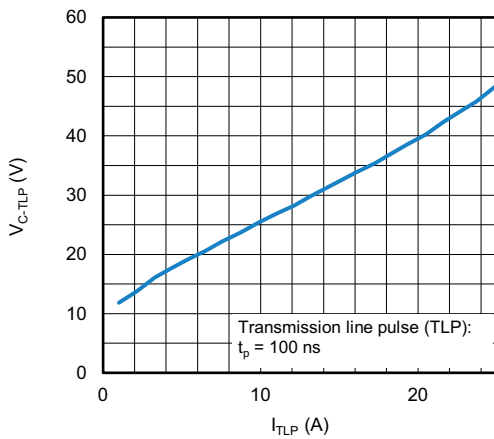
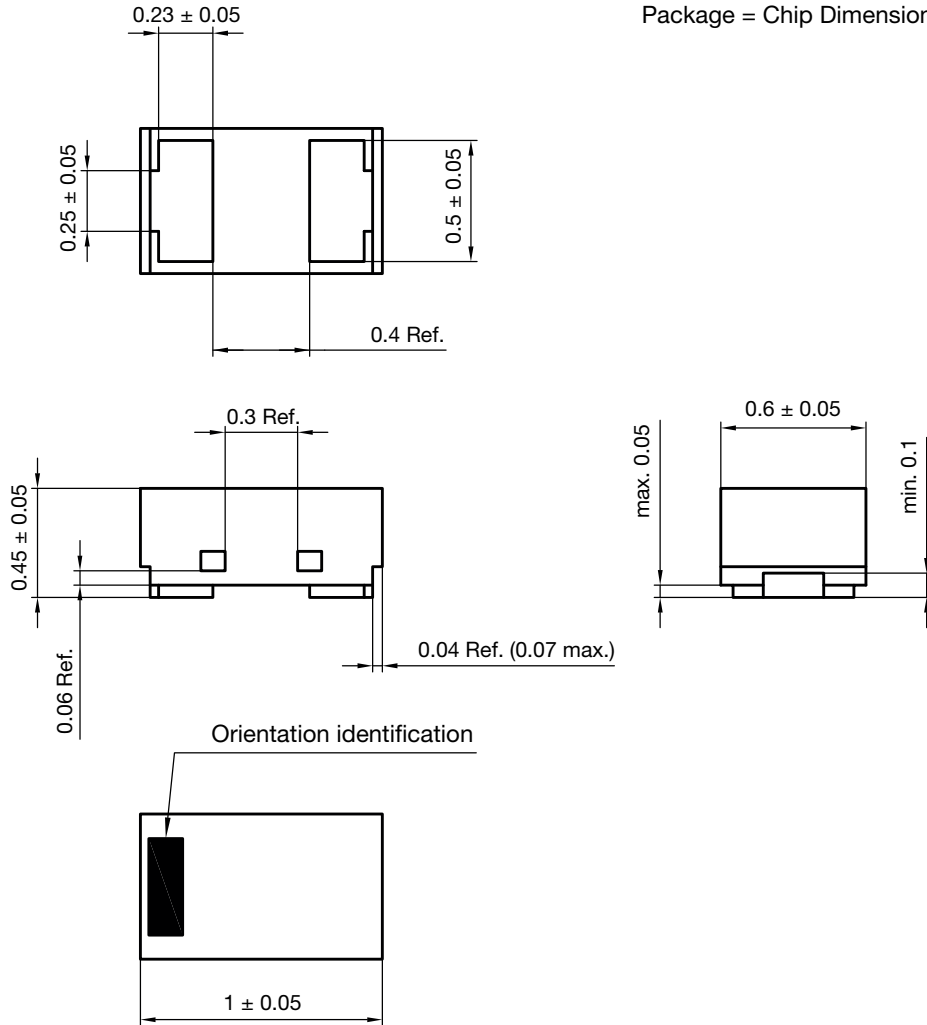


Fig. 5 - Typical Clamping Voltage vs. Peak Pulse Current

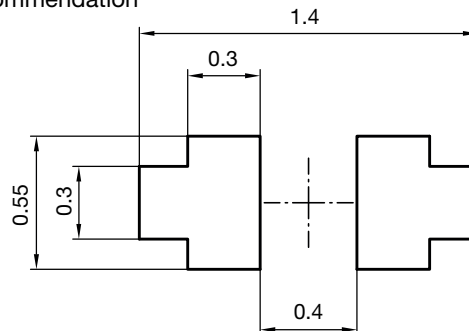


PACKAGE DIMENSIONS in millimeters (inches): **DFN1006-2B**

Package = Chip Dimension in mm



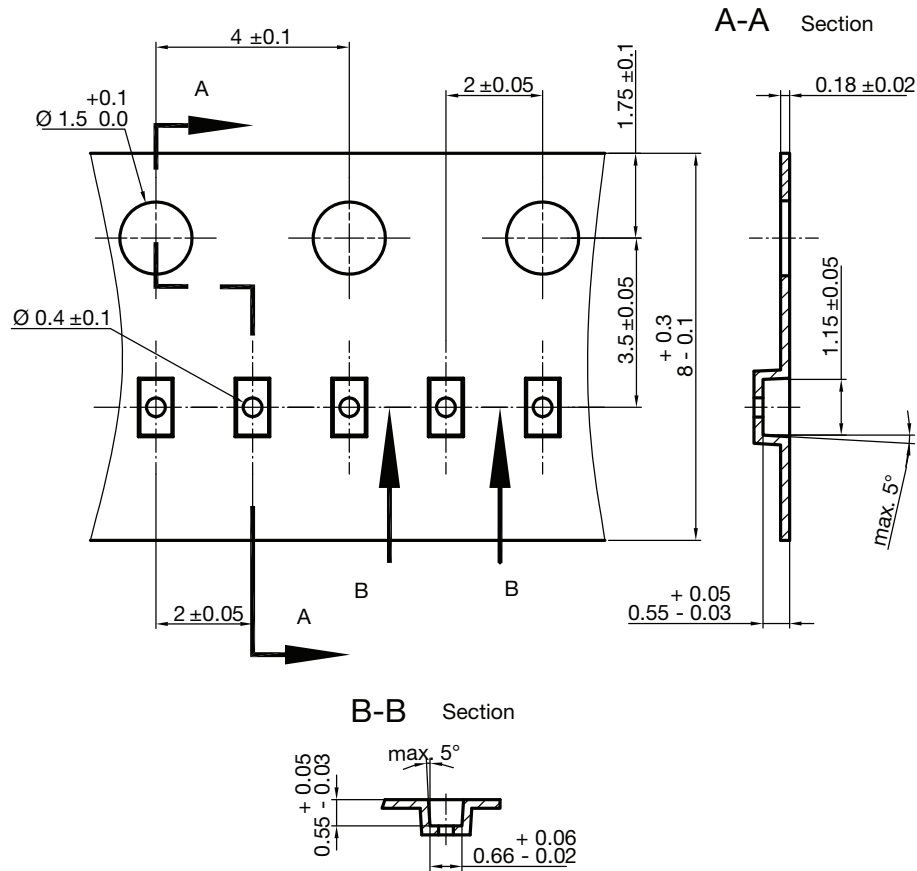
Footprint recommendation



Document no.: S8-V-3906.04-059 (4)
Created - Date: 11-Jul-2018
Rev.5 - Date: 17-Sep-2021

23191

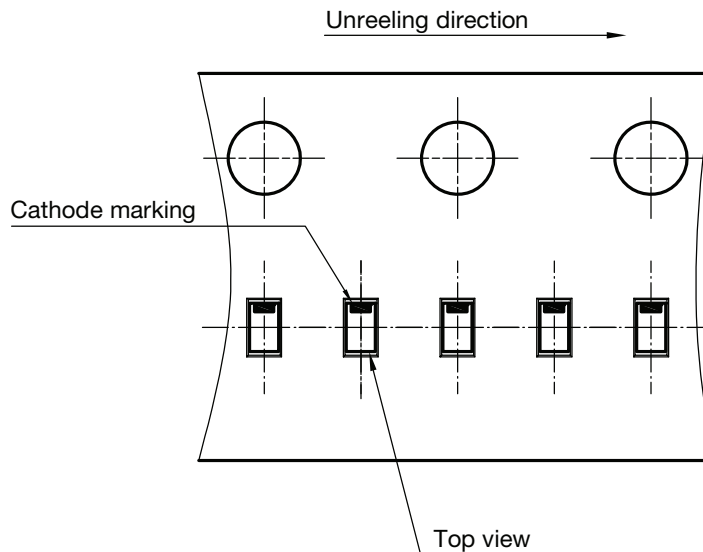
CARRIER TAPE DFN1006-2B



S8-V-3906.04-063 (4)
 created 28.10.2019

surface resistance: $10^5 - 10^{11} \frac{\text{OHMS}}{\text{SQ}}$
 Cumulative tolerances of 10 sprocket holes is ± 0.2 mm

ORIENTATION IN CARRIER TAPE DFN1006-2B



S8-V-3906.04-064 (4)
 created 28.10.2019



Disclaimer

ALL PRODUCT, PRODUCT SPECIFICATIONS AND DATA ARE SUBJECT TO CHANGE WITHOUT NOTICE TO IMPROVE RELIABILITY, FUNCTION OR DESIGN OR OTHERWISE.

Vishay Intertechnology, Inc., its affiliates, agents, and employees, and all persons acting on its or their behalf (collectively, "Vishay"), disclaim any and all liability for any errors, inaccuracies or incompleteness contained in any datasheet or in any other disclosure relating to any product.

Vishay makes no warranty, representation or guarantee regarding the suitability of the products for any particular purpose or the continuing production of any product. To the maximum extent permitted by applicable law, Vishay disclaims (i) any and all liability arising out of the application or use of any product, (ii) any and all liability, including without limitation special, consequential or incidental damages, and (iii) any and all implied warranties, including warranties of fitness for particular purpose, non-infringement and merchantability.

Statements regarding the suitability of products for certain types of applications are based on Vishay's knowledge of typical requirements that are often placed on Vishay products in generic applications. Such statements are not binding statements about the suitability of products for a particular application. It is the customer's responsibility to validate that a particular product with the properties described in the product specification is suitable for use in a particular application. Parameters provided in datasheets and / or specifications may vary in different applications and performance may vary over time. All operating parameters, including typical parameters, must be validated for each customer application by the customer's technical experts. Product specifications do not expand or otherwise modify Vishay's terms and conditions of purchase, including but not limited to the warranty expressed therein.

Hyperlinks included in this datasheet may direct users to third-party websites. These links are provided as a convenience and for informational purposes only. Inclusion of these hyperlinks does not constitute an endorsement or an approval by Vishay of any of the products, services or opinions of the corporation, organization or individual associated with the third-party website. Vishay disclaims any and all liability and bears no responsibility for the accuracy, legality or content of the third-party website or for that of subsequent links.

Except as expressly indicated in writing, Vishay products are not designed for use in medical, life-saving, or life-sustaining applications or for any other application in which the failure of the Vishay product could result in personal injury or death. Customers using or selling Vishay products not expressly indicated for use in such applications do so at their own risk. Please contact authorized Vishay personnel to obtain written terms and conditions regarding products designed for such applications.

No license, express or implied, by estoppel or otherwise, to any intellectual property rights is granted by this document or by any conduct of Vishay. Product names and markings noted herein may be trademarks of their respective owners.