

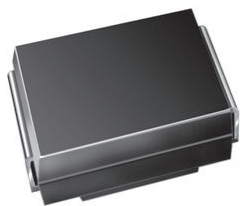

Surface-Mount TRANSZORB® Transient Voltage Suppressors



SMB (DO-214AA)

LINKS TO ADDITIONAL RESOURCES



| PRIMARY CHARACTERISTICS | |
|--|-------------------------------|
| V _{BR} (unidirectional) | 6.5 V to 228 V |
| V _{BR} (bidirectional) | 6.5 V to 145 V |
| V _{WM} (unidirectional) | 5.0 V to 188 V |
| V _{WM} (bidirectional) | 5.0 V to 120 V |
| P _{PPM} | 600 W |
| P _D at T _M = 50 °C | 5.0 W |
| P _D at T _A = 25 °C | 1.0 W |
| T _J max. | 150 °C |
| Polarity | Unidirectional, bidirectional |
| Package | SMB (DO-214AA) |

DEVICES FOR BIDIRECTIONAL APPLICATIONS

For bidirectional devices use CD suffix (e.g. SMBJ5.0CD). Electrical characteristics apply in both directions.

| MAXIMUM RATINGS (T _A = 25 °C unless otherwise noted) | | | | |
|---|----------------------------|-----------------------------------|----------------|------|
| PARAMETER | | SYMBOL | VALUE | UNIT |
| Peak pulse power dissipation | with a 10/1000 μs waveform | P _{PPM} ⁽¹⁾ | 600 | W |
| Peak pulse current | with a 10/1000 μs waveform | I _{PPM} ⁽¹⁾ | See next table | A |
| Power dissipation | T _M = 50 °C | P _D ⁽²⁾ | 5.0 | W |
| | T _A = 25 °C | P _D ⁽³⁾ | 1.0 | |
| Operating junction and storage temperature range | | T _J , T _{STG} | -55 to +150 | °C |

Notes

- (1) Non-repetitive current pulse, per fig. 3 and derated above T_A = 25 °C per fig. 2
- (2) Power dissipation mounted on infinite heatsink
- (3) Power dissipation mounted on minimum recommended pad layout

FEATURES

- Low profile package
- Ideal for automated placement
- ± 3.5 %: very tight V_{BR} tolerance
- Low leakage current
- Available in unidirectional and bidirectional
- 600 W peak pulse power capability with a 10/1000 μs waveform, repetitive rate (duty cycle): 0.01 %
- Excellent clamping capability
- Very fast response time
- Low incremental surge resistance
- Meets MSL level 1, per J-STD-020, LF maximum peak of 260 °C
- Material categorization: for definitions of compliance please see www.vishay.com/doc?99912



RoHS COMPLIANT HALOGEN FREE

TYPICAL APPLICATIONS

Use in sensitive electronics protection against voltage transients induced by inductive load switching and lighting on ICs, MOSFETs, signal lines of sensor units for consumer, computer, industrial, and telecommunication.

MECHANICAL DATA

Case: SMB (DO-214AA)

Molding compound meets UL 94 V-0 flammability rating
Base P/N-M3 - halogen-free, RoHS-compliant, and industrial grade

Terminals: matte tin plated leads, solderable per J-STD-002 and JESD 22-B102

M3 suffix meets JESD 201 class 2 whisker test

Polarity: for unidirectional types the band denotes cathode end, no cathode band on bidirectional types



| ELECTRICAL CHARACTERISTICS (T _A = 25 °C unless otherwise noted) | | | | | | | | | |
|--|---------------------|-----|---|------|----------------------------------|---------------------------------------|--|---|---|
| DEVICE TYPE | DEVICE MARKING CODE | | BREAKDOWN VOLTAGE V _{BR} AT I _T (1) | | TEST CURRENT I _T (mA) | STAND-OFF VOLTAGE V _{WM} (V) | MAXIMUM REVERSE LEAKAGE AT V _{WM} I _D (μA) (2) | MAXIMUM PEAK PULSE SURGE CURRENT I _{PPM} (A) (3) | MAXIMUM CLAMPING VOLTAGE AT I _{PPM} V _C (V) |
| | UNI | BI | MIN. | MAX. | | | | | |
| (+)SMBJ5.0D | 6AA | 6AA | 6.50 | 6.97 | 10 | 5.0 | 500 | 65.9 | 9.1 |
| (+)SMBJ6.0D | 6AB | 6AB | 6.77 | 7.27 | 10 | 6.0 | 500 | 58.9 | 10.2 |
| (+)SMBJ6.5D | 6AC | 6AC | 7.33 | 7.87 | 10 | 6.5 | 300 | 54.5 | 11.0 |
| (+)SMBJ7.0D | 6AD | 6AD | 7.90 | 8.48 | 10 | 7.0 | 150 | 50.8 | 11.8 |
| (+)SMBJ7.5D | 6AE | 6AE | 8.46 | 9.08 | 1.0 | 7.5 | 75 | 47.2 | 12.7 |
| (+)SMBJ8.0D | 6AF | 6AF | 9.03 | 9.69 | 1.0 | 8.0 | 35 | 44.8 | 13.4 |
| (+)SMBJ8.5D | 6AG | 6AG | 9.57 | 10.3 | 1.0 | 8.5 | 15 | 42.2 | 14.3 |
| (+)SMBJ9.0D | 6AH | 6AH | 10.2 | 10.9 | 1.0 | 9.0 | 5.0 | 39.7 | 15.1 |
| (+)SMBJ10D | 6AK | 6AK | 11.3 | 12.1 | 1.0 | 10 | 2.0 | 35.9 | 16.7 |
| (+)SMBJ11D | 6AL | 6AL | 12.4 | 13.3 | 1.0 | 11 | 2.0 | 33.5 | 17.9 |
| (+)SMBJ12D | 6AM | 6AM | 13.5 | 14.5 | 1.0 | 12 | 2.0 | 30.6 | 19.6 |
| (+)SMBJ13D | 6AN | 6AN | 14.6 | 15.7 | 1.0 | 13 | 0.5 | 28.3 | 21.2 |
| (+)SMBJ14D | 6AP | 6AP | 15.8 | 17.0 | 1.0 | 14 | 0.5 | 26.2 | 22.9 |
| (+)SMBJ15D | 6AQ | 6AQ | 17.0 | 18.2 | 1.0 | 15 | 0.5 | 25.0 | 24.0 |
| (+)SMBJ16D | 6AR | 6AR | 18.1 | 19.4 | 1.0 | 16 | 0.5 | 23.4 | 25.6 |
| (+)SMBJ17D | 6AS | 6AS | 19.2 | 20.6 | 1.0 | 17 | 0.5 | 22.1 | 27.2 |
| (+)SMBJ18D | 6AT | 6AT | 20.3 | 21.8 | 1.0 | 18 | 0.5 | 20.8 | 28.8 |
| (+)SMBJ20D | 6AU | 6AU | 22.5 | 24.2 | 1.0 | 20 | 0.5 | 18.8 | 32.0 |
| (+)SMBJ22D | 6AV | 6AV | 24.8 | 26.6 | 1.0 | 22 | 0.5 | 17.1 | 35.1 |
| (+)SMBJ24D | 6AW | 6AW | 27.1 | 29.1 | 1.0 | 24 | 0.5 | 15.6 | 38.4 |
| (+)SMBJ26D | 6AX | 6AX | 29.3 | 31.5 | 1.0 | 26 | 0.5 | 14.5 | 41.6 |
| (+)SMBJ28D | 6AY | 6AY | 31.6 | 33.9 | 1.0 | 28 | 0.5 | 13.4 | 44.7 |
| (+)SMBJ30D | 6AZ | 6AZ | 33.8 | 36.3 | 1.0 | 30 | 0.5 | 12.6 | 47.7 |
| (+)SMBJ33D | 6BA | 6BA | 37.3 | 40.0 | 1.0 | 33 | 0.5 | 11.5 | 52.5 |
| (+)SMBJ36D | 6BB | 6BB | 40.6 | 43.6 | 1.0 | 36 | 0.5 | 10.5 | 57.3 |
| (+)SMBJ40D | 6BC | 6BC | 45.1 | 48.4 | 1.0 | 40 | 0.5 | 9.43 | 63.6 |
| (+)SMBJ43D | 6BD | 6BD | 48.5 | 52.1 | 1.0 | 43 | 0.5 | 8.76 | 68.5 |
| (+)SMBJ45D | 6BE | 6BE | 50.8 | 54.5 | 1.0 | 45 | 0.5 | 8.40 | 71.6 |
| (+)SMBJ48D | 6BF | 6BF | 54.1 | 58.1 | 1.0 | 48 | 0.5 | 7.90 | 76.3 |
| (+)SMBJ51D | 6BG | 6BG | 57.6 | 61.8 | 1.0 | 51 | 0.5 | 7.40 | 81.2 |
| (+)SMBJ54D | 6BH | 6BH | 60.9 | 65.4 | 1.0 | 54 | 0.5 | 7.00 | 85.9 |
| (+)SMBJ58D | 6BK | 6BK | 65.4 | 70.2 | 1.0 | 58 | 0.5 | 6.50 | 92.3 |
| (+)SMBJ60D | 6BL | 6BL | 67.7 | 72.7 | 1.0 | 60 | 0.5 | 6.28 | 95.5 |
| (+)SMBJ64D | 6BM | 6BM | 72.2 | 77.5 | 1.0 | 64 | 0.5 | 5.88 | 102 |
| (+)SMBJ70D | 6BN | 6BN | 79.0 | 84.8 | 1.0 | 70 | 0.5 | 5.40 | 111 |
| (+)SMBJ75D | 6BP | 6BP | 84.6 | 90.8 | 1.0 | 75 | 0.5 | 5.06 | 119 |
| (+)SMBJ78D | 6BQ | 6BQ | 88.1 | 94.4 | 1.0 | 78 | 0.5 | 4.86 | 124 |
| (+)SMBJ85D | 6BR | 6BR | 95.7 | 103 | 1.0 | 85 | 0.5 | 4.46 | 135 |
| (+)SMBJ90D | 6BS | 6BS | 102 | 109 | 1.0 | 90 | 0.5 | 4.17 | 144 |
| (+)SMBJ100D | 6BT | 6BT | 113 | 121 | 1.0 | 100 | 0.5 | 3.77 | 159 |
| (+)SMBJ110D | 6BU | 6BU | 124 | 133 | 1.0 | 110 | 0.5 | 3.45 | 174 |
| (+)SMBJ120D | 6BV | 6BV | 135 | 145 | 1.0 | 120 | 0.5 | 3.15 | 190 |
| (+)SMBJ130D | 6BW | - | 146 | 157 | 1.0 | 130 | 0.5 | 2.94 | 206 |
| (+)SMBJ150D | 6BX | - | 170 | 182 | 1.0 | 150 | 0.5 | 2.53 | 239 |
| (+)SMBJ160D | 6BY | - | 181 | 194 | 1.0 | 160 | 0.5 | 2.34 | 256 |
| (+)SMBJ170D | 6BZ | - | 192 | 206 | 1.0 | 170 | 0.5 | 2.23 | 270 |
| SMBJ188D | 6CA | - | 212 | 228 | 1.0 | 188 | 0.5 | 2.03 | 301 |

Notes

- All terms and symbols are consistent with ANSI/IEEE C62.35
- (1) Pulse test: t_p ≤ 50 ms
- (2) For bi-directional types having V_{WM} of 12 V and less, the I_D limit is doubled
- (3) Surge current waveform per fig. 3 and derate per fig. 2
- (+) Underwriters Laboratory Recognition for the classification of protectors (QVGQ2) under the UL standard for safety 497B and file number E136766 for both uni-directional and bi-directional device



| THERMAL CHARACTERISTICS (T _A = 25 °C unless otherwise noted) | | | |
|---|----------------------|-------|------|
| PARAMETER | SYMBOL | VALUE | UNIT |
| Typical thermal resistance, junction to ambient | R _{θJA} (1) | 125 | °C/W |
| | R _{θJA} (2) | 100 | |
| Typical thermal resistance, junction to mount | R _{θJM} | 20 | |

Notes

- (1) Mounted on minimum recommended pad layout
- (2) Mounted on 5.0 mm x 5.0 mm copper pad area

| ORDERING INFORMATION (Example) | | | | |
|--------------------------------|-----------------|------------------------|---------------|------------------------------------|
| PREFERRED P/N | UNIT WEIGHT (g) | PREFERRED PACKAGE CODE | BASE QUANTITY | DELIVERY MODE |
| SMBJ5.0D-M3/H | 0.096 | H | 750 | 7" diameter plastic tape and reel |
| SMBJ5.0D-M3/I | 0.096 | I | 3200 | 13" diameter plastic tape and reel |

RATINGS AND CHARACTERISTICS CURVES (T_A = 25 °C unless otherwise noted)

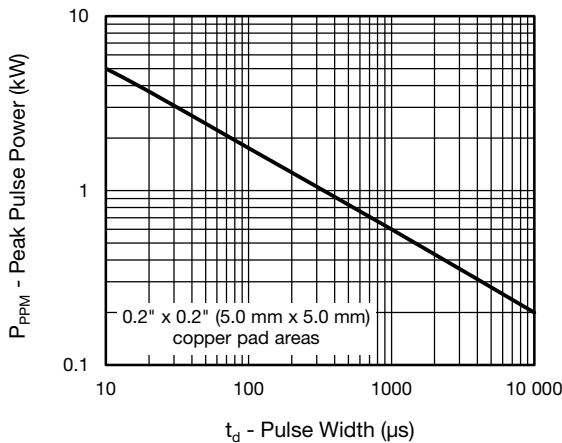

Fig. 1 - Peak Pulse Power Rating Curve

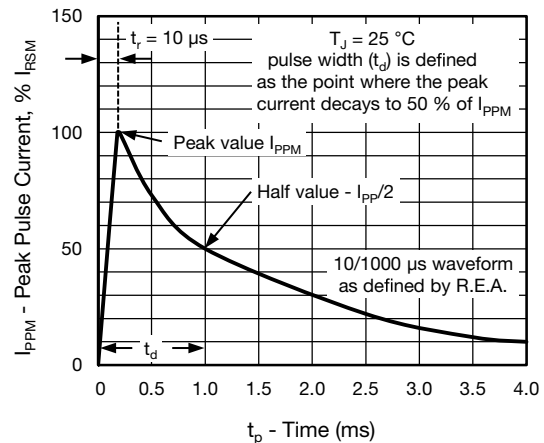

Fig. 3 - Pulse Waveform

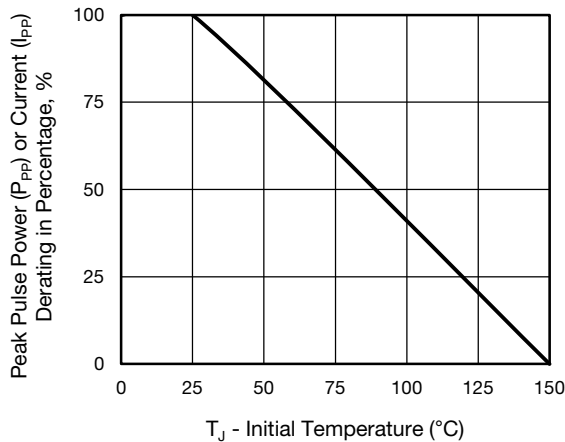

Fig. 2 - Pulse Power or Current vs. Initial Junction Temperature

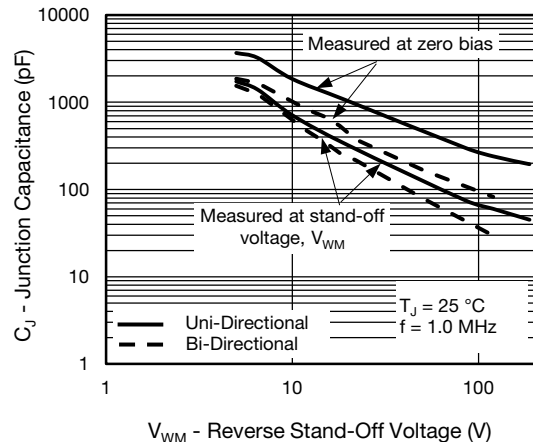

Fig. 4 - Typical Junction Capacitance

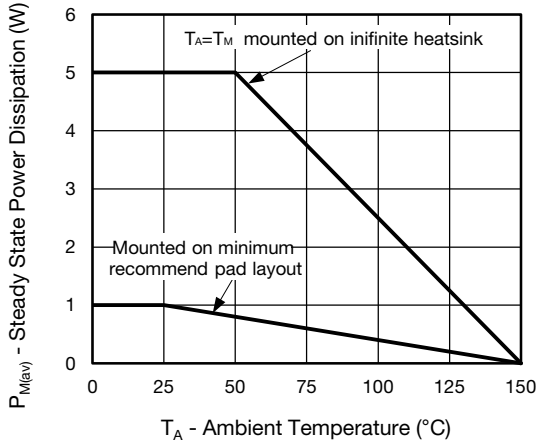

Fig. 5 - Power Dissipation Derating Curve

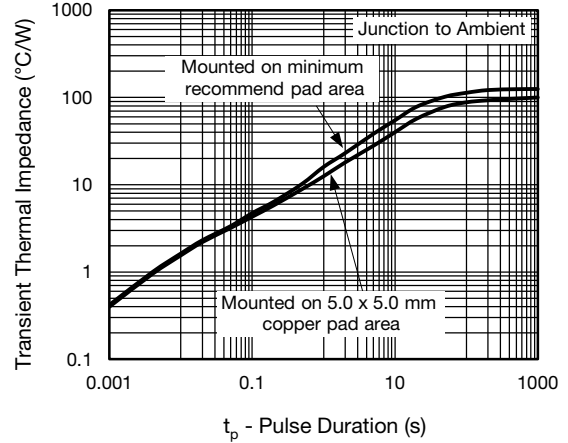
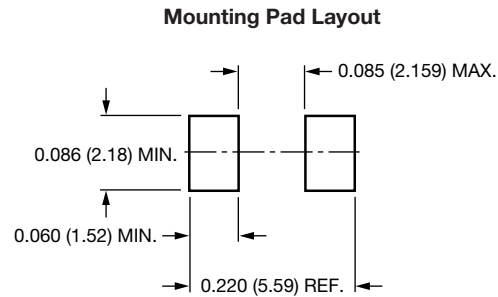
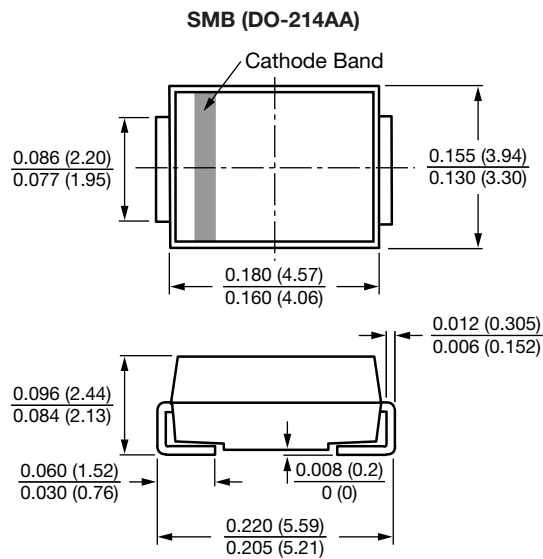

Fig. 6 - Typical Transient Thermal Impedance

Note

- Fig.1, 10 000 μ s P_{ppm} is actual test for $V_{WM} \leq 60$ V types, over 60 V types 10 000 μ s P_{ppm} is curve extensional value

PACKAGE OUTLINE DIMENSIONS in inches (millimeters)





Disclaimer

ALL PRODUCT, PRODUCT SPECIFICATIONS AND DATA ARE SUBJECT TO CHANGE WITHOUT NOTICE TO IMPROVE RELIABILITY, FUNCTION OR DESIGN OR OTHERWISE.

Vishay Intertechnology, Inc., its affiliates, agents, and employees, and all persons acting on its or their behalf (collectively, "Vishay"), disclaim any and all liability for any errors, inaccuracies or incompleteness contained in any datasheet or in any other disclosure relating to any product.

Vishay makes no warranty, representation or guarantee regarding the suitability of the products for any particular purpose or the continuing production of any product. To the maximum extent permitted by applicable law, Vishay disclaims (i) any and all liability arising out of the application or use of any product, (ii) any and all liability, including without limitation special, consequential or incidental damages, and (iii) any and all implied warranties, including warranties of fitness for particular purpose, non-infringement and merchantability.

Statements regarding the suitability of products for certain types of applications are based on Vishay's knowledge of typical requirements that are often placed on Vishay products in generic applications. Such statements are not binding statements about the suitability of products for a particular application. It is the customer's responsibility to validate that a particular product with the properties described in the product specification is suitable for use in a particular application. Parameters provided in datasheets and / or specifications may vary in different applications and performance may vary over time. All operating parameters, including typical parameters, must be validated for each customer application by the customer's technical experts. Product specifications do not expand or otherwise modify Vishay's terms and conditions of purchase, including but not limited to the warranty expressed therein.

Hyperlinks included in this datasheet may direct users to third-party websites. These links are provided as a convenience and for informational purposes only. Inclusion of these hyperlinks does not constitute an endorsement or an approval by Vishay of any of the products, services or opinions of the corporation, organization or individual associated with the third-party website. Vishay disclaims any and all liability and bears no responsibility for the accuracy, legality or content of the third-party website or for that of subsequent links.

Except as expressly indicated in writing, Vishay products are not designed for use in medical, life-saving, or life-sustaining applications or for any other application in which the failure of the Vishay product could result in personal injury or death. Customers using or selling Vishay products not expressly indicated for use in such applications do so at their own risk. Please contact authorized Vishay personnel to obtain written terms and conditions regarding products designed for such applications.

No license, express or implied, by estoppel or otherwise, to any intellectual property rights is granted by this document or by any conduct of Vishay. Product names and markings noted herein may be trademarks of their respective owners.