

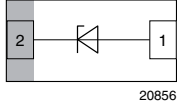

Single-Line ESD-Protection Diode in DFN1006-2A



MARKING (example only)



Bar = cathode marking
X = date code
YY = type code (see table below)

FEATURES

- Compact DFN1006-2A package
- Low package height < 0.5 mm
- 1-line unidirectional ESD-protection
- AEC-Q101 qualified available
- Working range 1 V to 33 V
- ESD immunity acc. IEC 61000-4-2
±15 kV to ±30 kV contact discharge
±15 kV to ±30 kV air discharge
- Lead plating: Sn (e3)
- soldering can be checked by standard vision inspection
- AOI = Automated Optical Inspection
- Material categorization: for definitions of compliance please see www.vishay.com/doc?99912



LINKS TO ADDITIONAL RESOURCES



ORDERING INFORMATION					
PART NUMBER (EXAMPLE)	AEC-Q101 QUALIFIED	ENVIRONMENTAL AND QUALITY CODE			ORDERING CODE (EXAMPLE)
		RoHS COMPLIANT + LEAD (Pb)-FREE TERMINATIONS	TIN PLATED	10K PER 7" REEL (8 mm TAPE)	
		GREEN		MOQ = 10K/BOX	
VESD05C1-HD1	-	G	3	-08	VESD05C1-HD1-G3-08
VESD05C1-HD1	H	G	3	-08	VESD05C1-HD1HG3-08

PACKAGE DATA						
DEVICE NAME	PACKAGE NAME	TYPE CODE	WEIGHT	MOLDING COMPOUND FLAMMABILITY RATING	MOISTURE SENSITIVITY LEVEL	SOLDERING CONDITIONS
VESD01C1-HD1	DFN1006-2A	2A	0.83 mg	UL 94 V-0	MSL level 1 (according J-STD-020)	Peak temperature max. 260 °C
VESD03C1-HD1		2B				
VESD05C1-HD1		2G				
VESD08C1-HD1		2D				
VESD12C1-HD1		2E				
VESD16C1-HD1		2H				
VESD26C1-HD1		2J				
VESD33C1-HD1		2K				



ABSOLUTE MAXIMUM RATINGS VESD01C1-HD1 (T _{amb} = 25 °C, unless otherwise specified)				
PARAMETER	TEST CONDITIONS	SYMBOL	VALUE	UNIT
Peak pulse current	Acc. IEC 61000-4-5, 8/20 µs/single shot	I _{PPM}	11	A
Peak pulse power	Acc. IEC 61000-4-5, 8/20 µs/single shot	P _{PP}	100	W
ESD immunity	Contact discharge acc. IEC 61000-4-2; 10 pulses	V _{ESD}	30	kV
	Air discharge acc. IEC 61000-4-2; 10 pulses		30	kV
Operating temperature	Junction temperature	T _J	-55 to +150	°C
Storage temperature		T _{stg}	-65 to +150	°C

ABSOLUTE MAXIMUM RATINGS VESD03C1-HD1 (T _{amb} = 25 °C, unless otherwise specified)				
PARAMETER	TEST CONDITIONS	SYMBOL	VALUE	UNIT
Peak pulse current	Acc. IEC 61000-4-5, 8/20 µs/single shot	I _{PPM}	11.6	A
Peak pulse power	Acc. IEC 61000-4-5, 8/20 µs/single shot	P _{PP}	100	W
ESD immunity	Contact discharge acc. IEC 61000-4-2; 10 pulses	V _{ESD}	30	kV
	Air discharge acc. IEC 61000-4-2; 10 pulses		30	kV
Operating temperature	Junction temperature	T _J	-55 to +150	°C
Storage temperature		T _{stg}	-65 to +150	°C

ABSOLUTE MAXIMUM RATINGS VESD05C1-HD1 (T _{amb} = 25 °C, unless otherwise specified)				
PARAMETER	TEST CONDITIONS	SYMBOL	VALUE	UNIT
Peak pulse current	Acc. IEC 61000-4-5, 8/20 µs/single shot	I _{PPM}	8.7	A
Peak pulse power	Acc. IEC 61000-4-5, 8/20 µs/single shot	P _{PP}	100	W
ESD immunity	Contact discharge acc. IEC 61000-4-2; 10 pulses	V _{ESD}	30	kV
	Air discharge acc. IEC 61000-4-2; 10 pulses		30	kV
Operating temperature	Junction temperature	T _J	-55 to +150	°C
Storage temperature		T _{stg}	-65 to +150	°C

ABSOLUTE MAXIMUM RATINGS VESD08C1-HD1 (T _{amb} = 25 °C, unless otherwise specified)				
PARAMETER	TEST CONDITIONS	SYMBOL	VALUE	UNIT
Peak pulse current	Acc. IEC 61000-4-5, 8/20 µs/single shot	I _{PPM}	6.60	A
Peak pulse power	Acc. IEC 61000-4-5, 8/20 µs/single shot	P _{PP}	100	W
ESD immunity	Contact discharge acc. IEC 61000-4-2; 10 pulses	V _{ESD}	30	kV
	Air discharge acc. IEC 61000-4-2; 10 pulses		30	kV
Operating temperature	Junction temperature	T _J	-55 to +150	°C
Storage temperature		T _{stg}	-65 to +150	°C

**ABSOLUTE MAXIMUM RATINGS VESD12C1-HD1**(T_{amb} = 25 °C, unless otherwise specified)

PARAMETER	TEST CONDITIONS	SYMBOL	VALUE	UNIT
Peak pulse current	Acc. IEC 61000-4-5, 8/20 µs/single shot	I _{PPM}	4.4	A
Peak pulse power	Acc. IEC 61000-4-5, 8/20 µs/single shot	P _{PP}	100	W
ESD immunity	Contact discharge acc. IEC 61000-4-2; 10 pulses	V _{ESD}	30	kV
	Air discharge acc. IEC 61000-4-2; 10 pulses		30	kV
Operating temperature	Junction temperature	T _J	-55 to +150	°C
Storage temperature		T _{stg}	-65 to +150	°C

ABSOLUTE MAXIMUM RATINGS VESD16C1-HD1(T_{amb} = 25 °C, unless otherwise specified)

PARAMETER	TEST CONDITIONS	SYMBOL	VALUE	UNIT
Peak pulse current	Acc. IEC 61000-4-5, 8/20 µs/single shot	I _{PPM}	3.6	A
Peak pulse power	Acc. IEC 61000-4-5, 8/20 µs/single shot	P _{PP}	100	W
ESD immunity	Contact discharge acc. IEC 61000-4-2; 10 pulses	V _{ESD}	30	kV
	Air discharge acc. IEC 61000-4-2; 10 pulses		30	kV
Operating temperature	Junction temperature	T _J	-55 to +150	°C
Storage temperature		T _{stg}	-65 to +150	°C

ABSOLUTE MAXIMUM RATINGS VESD26C1-HD1(T_{amb} = 25 °C, unless otherwise specified)

PARAMETER	TEST CONDITIONS	SYMBOL	VALUE	UNIT
Peak pulse current	Acc. IEC 61000-4-5, 8/20 µs/single shot	I _{PPM}	2.1	A
Peak pulse power	Acc. IEC 61000-4-5, 8/20 µs/single shot	P _{PP}	100	W
ESD immunity	Contact discharge acc. IEC 61000-4-2; 10 pulses	V _{ESD}	20	kV
	Air discharge acc. IEC 61000-4-2; 10 pulses		20	kV
Operating temperature	Junction temperature	T _J	-55 to +150	°C
Storage temperature		T _{stg}	-65 to +150	°C

ABSOLUTE MAXIMUM RATINGS VESD33C1-HD1(T_{amb} = 25 °C, unless otherwise specified)

PARAMETER	TEST CONDITIONS	SYMBOL	VALUE	UNIT
Peak pulse current	Acc. IEC 61000-4-5, 8/20 µs/single shot	I _{PPM}	1.6	A
Peak pulse power	Acc. IEC 61000-4-5, 8/20 µs/single shot	P _{PP}	100	W
ESD immunity	Contact discharge acc. IEC 61000-4-2; 10 pulses	V _{ESD}	15	kV
	Air discharge acc. IEC 61000-4-2; 10 pulses		15	kV
Operating temperature	Junction temperature	T _J	-55 to +150	°C
Storage temperature		T _{stg}	-65 to +150	°C



ELECTRICAL CHARACTERISTICS VESD01C1-HD1 ($T_{amb} = 25\text{ }^{\circ}\text{C}$, unless otherwise specified)						
PARAMETER	TEST CONDITIONS / REMARKS	SYMBOL	MIN.	TYP.	MAX.	UNIT
Protection paths	Number of lines which can be protected	$N_{channel}$	-	-	1	lines
Reverse stand off voltage	Max. reverse working voltage	V_{RWM}	-	-	1	V
Reverse voltage	at $I_R = 100\text{ }\mu\text{A}$	V_R	1	1.2	-	V
Reverse current	at $V_R = 1\text{ V}$	I_R	-	20	100	μA
Reverse breakdown voltage	at $I_R = 5\text{ mA}$	V_{BR}	2.55	2.7	2.85	V
Reverse clamping voltage	at $I_{PP} = I_{PPM} = 11\text{ A}$, $t_p = 8/20\text{ }\mu\text{s}$	V_C	-	6.4	6.9	V
Forward clamping voltage	at $I_{PP} = 1\text{ A}$, $t_p = 300\text{ }\mu\text{s}$	V_F	0.9	1.1	1.2	V
	at $I_{PP} = I_{PPM} = 11\text{ A}$, $t_p = 8/20\text{ }\mu\text{s}$	V_F	-	3.2	3.92	V
Dynamic resistance	$t_p = 100\text{ ns}$ (TLP; pin 2-1)	r_{dyn}	-	0.13	-	Ω
Capacitance	at $V_R = 0\text{ V}$; $f = 1\text{ MHz}$	C_D	153	192	230	pF

ELECTRICAL CHARACTERISTICS VESD03C1-HD1 ($T_{amb} = 25\text{ }^{\circ}\text{C}$, unless otherwise specified)						
PARAMETER	TEST CONDITIONS / REMARKS	SYMBOL	MIN.	TYP.	MAX.	UNIT
Protection paths	Number of lines which can be protected	$N_{channel}$	-	-	1	lines
Reverse stand off voltage	Max. reverse working voltage	V_{RWM}	-	-	3	V
Reverse voltage	at $I_R = 80\text{ }\mu\text{A}$	V_R	3	-	-	V
Reverse current	at $V_R = 3\text{ V}$	I_R	-	30	80	μA
Reverse breakdown voltage	at $I_R = 5\text{ mA}$	V_{BR}	4.45	4.7	4.95	V
Reverse clamping voltage	at $I_{PP} = I_{PPM} = 11.6\text{ A}$, $t_p = 8/20\text{ }\mu\text{s}$	V_C	-	7.8	8.70	V
Forward clamping voltage	at $I_{PP} = 1\text{ A}$, $t_p = 300\text{ }\mu\text{s}$	V_F	0.9	1.1	1.2	V
	at $I_{PP} = I_{PPM} = 11.6\text{ A}$, $t_p = 8/20\text{ }\mu\text{s}$	V_F	-	2.6	3.32	V
Dynamic resistance	$t_p = 100\text{ ns}$ (TLP; pin 2-1)	r_{dyn}	-	0.19	-	Ω
Capacitance	at $V_R = 0\text{ V}$; $f = 1\text{ MHz}$	C_D	89	112	135	pF

ELECTRICAL CHARACTERISTICS VESD05C1-HD1 ($T_{amb} = 25\text{ }^{\circ}\text{C}$, unless otherwise specified)						
PARAMETER	TEST CONDITIONS / REMARKS	SYMBOL	MIN.	TYP.	MAX.	UNIT
Protection paths	Number of lines which can be protected	$N_{channel}$	-	-	1	lines
Reverse stand off voltage	Max. reverse working voltage	V_{RWM}	-	-	5	V
Reverse voltage	at $I_R = 1\text{ }\mu\text{A}$	V_R	5	-	-	V
Reverse current	at $V_R = 5\text{ V}$	I_R	-	0.01	0.1	μA
Reverse breakdown voltage	at $I_R = 1\text{ mA}$	V_{BR}	7.1	7.5	7.9	V
Reverse clamping voltage	at $I_{PP} = I_{PPM} = 8.7\text{ A}$, $t_p = 8/20\text{ }\mu\text{s}$	V_C	-	10.3	11.5	V
Forward clamping voltage	at $I_{PP} = 1\text{ A}$, $t_p = 300\text{ }\mu\text{s}$	V_F	0.9	1.1	1.2	V
	at $I_{PP} = I_{PPM} = 8.7\text{ A}$, $t_p = 8/20\text{ }\mu\text{s}$	V_F	-	2.2	2.74	V
Dynamic resistance	$t_p = 100\text{ ns}$ (TLP; pin 2-1)	r_{dyn}	-	0.2	-	Ω
Capacitance	at $V_R = 0\text{ V}$; $f = 1\text{ MHz}$	C_D	53	67	81	pF



ELECTRICAL CHARACTERISTICS VESD08C1-HD1 ($T_{amb} = 25\text{ }^{\circ}\text{C}$, unless otherwise specified)						
PARAMETER	TEST CONDITIONS / REMARKS	SYMBOL	MIN.	TYP.	MAX.	UNIT
Protection paths	Number of lines which can be protected	$N_{channel}$	-	-	1	lines
Reverse stand off voltage	Max. reverse working voltage	V_{RWM}	-	-	8	V
Reverse voltage	at $I_R = 0.1\text{ }\mu\text{A}$	V_R	8	-	-	V
Reverse current	at $V_R = 8\text{ V}$	I_R	-	0.01	0.1	μA
Reverse breakdown voltage	at $I_R = 1\text{ mA}$	V_{BR}	9.4	9.85	10.3	V
Reverse clamping voltage	at $I_{PP} = I_{PPM} = 6.6\text{ A}$, $t_p = 8/20\text{ }\mu\text{s}$	V_C	-	13.7	15.3	V
Forward clamping voltage	at $I_{PP} = 1\text{ A}$, $t_p = 300\text{ }\mu\text{s}$	V_F	0.9	1.1	1.2	V
	at $I_{PP} = I_{PPM} = 6.6\text{ A}$, $t_p = 8/20\text{ }\mu\text{s}$	V_F	-	1.9	2.32	V
Dynamic resistance	$t_p = 100\text{ ns}$ (TLP; pin 2-1)	r_{dyn}	-	0.23	-	Ω
Capacitance	at $V_R = 0\text{ V}$; $f = 1\text{ MHz}$	C_D	37	47	57	pF

ELECTRICAL CHARACTERISTICS VESD12C1-HD1 ($T_{amb} = 25\text{ }^{\circ}\text{C}$, unless otherwise specified)						
PARAMETER	TEST CONDITIONS / REMARKS	SYMBOL	MIN.	TYP.	MAX.	UNIT
Protection paths	Number of lines which can be protected	$N_{channel}$	-	-	1	lines
Reverse stand off voltage	Max. reverse working voltage	V_{RWM}	-	-	12	V
Reverse voltage	at $I_R = 0.1\text{ }\mu\text{A}$	V_R	12	-	-	V
Reverse current	at $V_R = 12\text{ V}$	I_R	-	0.01	0.1	μA
Reverse breakdown voltage	at $I_R = 1\text{ mA}$	V_{BR}	14.3	15	15.8	V
Reverse clamping voltage	at $I_{PP} = I_{PPM} = 4.4\text{ A}$, $t_p = 8/20\text{ }\mu\text{s}$	V_C	-	20.5	22.7	V
Forward clamping voltage	at $I_{PP} = 1\text{ A}$, $t_p = 300\text{ }\mu\text{s}$	V_F	0.9	1.1	1.2	V
	at $I_{PP} = I_{PPM} = 4.4\text{ A}$, $t_p = 8/20\text{ }\mu\text{s}$	V_F	-	1.6	1.88	V
Dynamic resistance	$t_p = 100\text{ ns}$ (TLP; pin 2-1)	r_{dyn}	-	0.4	-	Ω
Capacitance	at $V_R = 0\text{ V}$; $f = 1\text{ MHz}$	C_D	26	33	40	pF

ELECTRICAL CHARACTERISTICS VESD16C1-HD1 ($T_{amb} = 25\text{ }^{\circ}\text{C}$, unless otherwise specified)						
PARAMETER	TEST CONDITIONS / REMARKS	SYMBOL	MIN.	TYP.	MAX.	UNIT
Protection paths	Number of lines which can be protected	$N_{channel}$	-	-	1	lines
Reverse stand off voltage	Max. reverse working voltage	V_{RWM}	-	-	16	V
Reverse voltage	at $I_R = 0.1\text{ }\mu\text{A}$	V_R	16	-	-	V
Reverse current	at $V_R = 16\text{ V}$	I_R	-	0.01	0.1	μA
Reverse breakdown voltage	at $I_R = 1\text{ mA}$	V_{BR}	17.1	18	18.9	V
Reverse clamping voltage	at $I_{PP} = I_{PPM} = 3.6\text{ A}$, $t_p = 8/20\text{ }\mu\text{s}$	V_C	-	25.3	28	V
Forward clamping voltage	at $I_{PP} = 1\text{ A}$, $t_p = 300\text{ }\mu\text{s}$	V_F	0.9	1.1	1.2	V
	at $I_{PP} = I_{PPM} = 3.6\text{ A}$, $t_p = 8/20\text{ }\mu\text{s}$	V_F	-	1.5	1.72	V
Dynamic resistance	$t_p = 100\text{ ns}$ (TLP; pin 2-1)	r_{dyn}	-	0.53	-	Ω
Capacitance	at $V_R = 0\text{ V}$; $f = 1\text{ MHz}$	C_D	21	27	33	pF



ELECTRICAL CHARACTERISTICS VESD26C1-HD1 ($T_{amb} = 25\text{ }^{\circ}\text{C}$, unless otherwise specified)						
PARAMETER	TEST CONDITIONS / REMARKS	SYMBOL	MIN.	TYP.	MAX.	UNIT
Protection paths	Number of lines which can be protected	$N_{channel}$	-	-	1	lines
Reverse stand off voltage	Max. reverse working voltage	V_{RWM}	-	-	26	V
Reverse voltage	at $I_R = 0.1\text{ }\mu\text{A}$	V_R	26	-	-	V
Reverse current	at $V_R = 26\text{ V}$	I_R	-	< 0.01	0.1	μA
Reverse breakdown voltage	at $I_R = 1\text{ mA}$	V_{BR}	28.5	30	31.5	V
Reverse clamping voltage	at $I_{PP} = I_{PPM} = 2.1\text{ A}$, $t_p = 8/20\text{ }\mu\text{s}$	V_C	-	43	48	V
Forward clamping voltage	at $I_{PP} = 1\text{ A}$, $t_p = 300\text{ }\mu\text{s}$	V_F	0.9	1.1	1.2	V
	at $I_{PP} = I_{PPM} = 2.1\text{ A}$, $t_p = 8/20\text{ }\mu\text{s}$	V_F	-	1.3	1.42	V
Dynamic resistance	$t_p = 100\text{ ns}$ (TLP; pin 2-1)	r_{dyn}	-	1.9	-	Ω
Capacitance	at $V_R = 0\text{ V}$; $f = 1\text{ MHz}$	C_D	14	17.5	21	pF

ELECTRICAL CHARACTERISTICS VESD33C1-HD1 ($T_{amb} = 25\text{ }^{\circ}\text{C}$, unless otherwise specified)						
PARAMETER	TEST CONDITIONS / REMARKS	SYMBOL	MIN.	TYP.	MAX.	UNIT
Protection paths	Number of lines which can be protected	$N_{channel}$	-	-	1	lines
Reverse stand off voltage	Max. reverse working voltage	V_{RWM}	-	-	33	V
Reverse voltage	at $I_R = 0.1\text{ }\mu\text{A}$	V_R	33	-	-	V
Reverse current	at $V_R = 33\text{ V}$	I_R	-	< 0.01	0.1	μA
Reverse breakdown voltage	at $I_R = 1\text{ mA}$	V_{BR}	37	39	41	V
Reverse clamping voltage	at $I_{PP} = I_{PPM} = 1.6\text{ A}$, $t_p = 8/20\text{ }\mu\text{s}$	V_C	-	56	62.5	V
Forward clamping voltage	at $I_{PP} = 1\text{ A}$, $t_p = 300\text{ }\mu\text{s}$	V_F	0.9	1.1	1.2	V
	at $I_{PP} = I_{PPM} = 1.6\text{ A}$, $t_p = 8/20\text{ }\mu\text{s}$	V_F	-	1.22	1.32	V
Dynamic resistance	$t_p = 100\text{ ns}$ (TLP; pin 2-1)	r_{dyn}	-	3.6	-	Ω
Capacitance	at $V_R = 0\text{ V}$; $f = 1\text{ MHz}$	C_D	12	15	18	pF

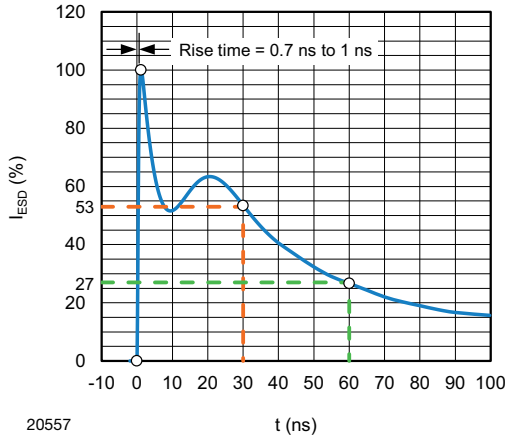

Fig. 1 - ESD Discharge Current Wave Form acc. IEC 61000-4-2 (330 Ω / 150 pF)

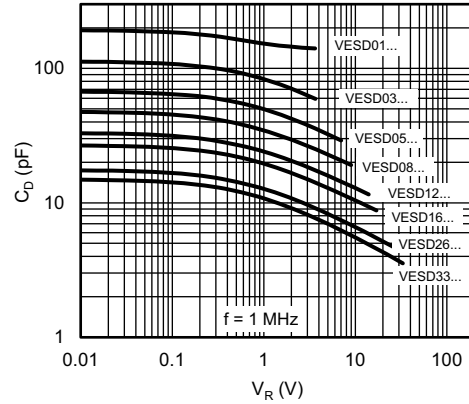

Fig. 4 - Typical Capacitance vs. Reverse Voltage

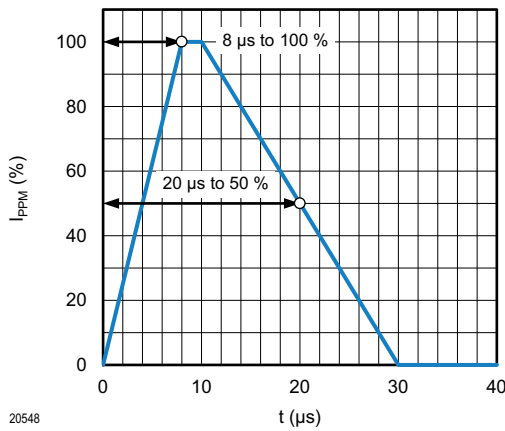

Fig. 2 - 8/20 μs Peak Pulse Current Wave Form acc. IEC 61000-4-5

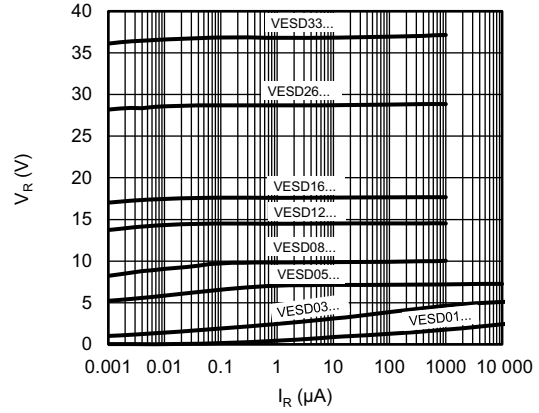

Fig. 5 - Typical Reverse Voltage vs. Reverse Current

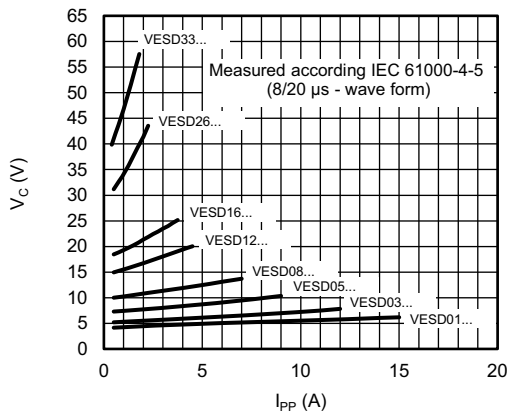

Fig. 3 - Typical Peak Clamping Voltage vs. Peak Pulse Current

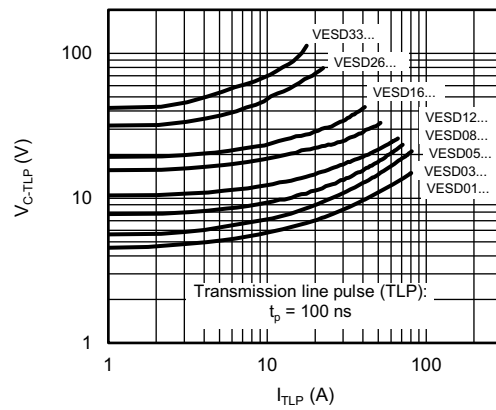

Fig. 6 - Typical Clamping Voltage vs. Peak Pulse Current

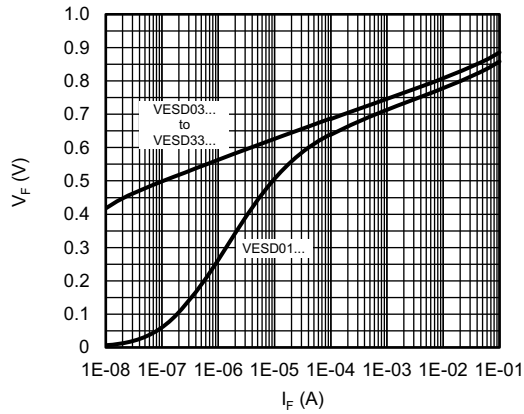

Fig. 7 - Typical Forward Voltage vs. Forward Current

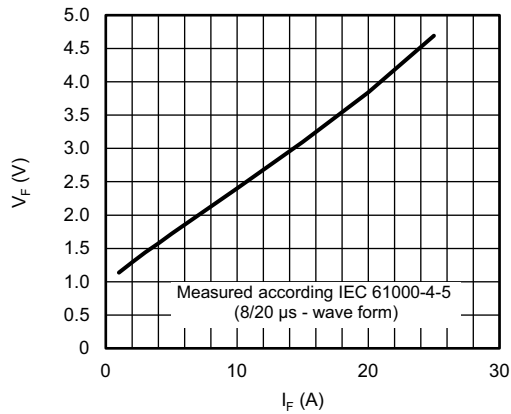
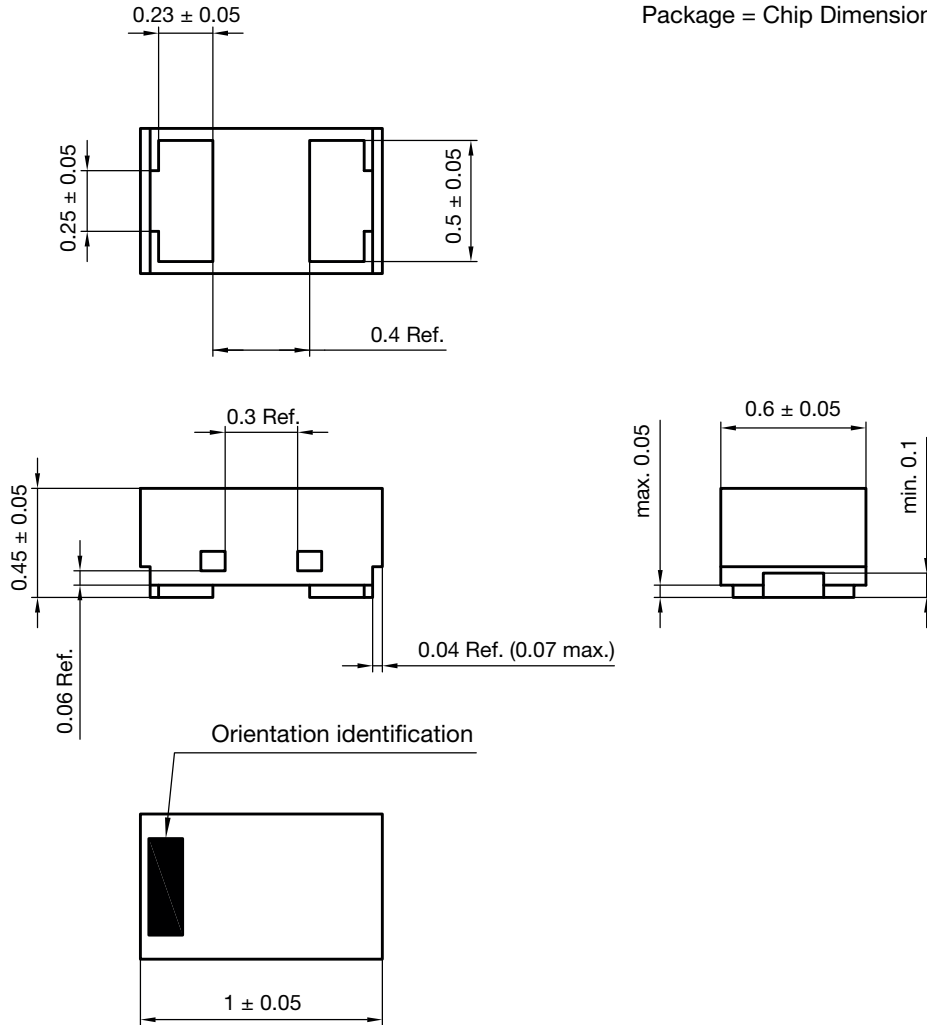

Fig. 8 - Typical Forward Voltage vs. Forward Current



PACKAGE DIMENSIONS in millimeters (Inches): DFN1006-2A

Package = Chip Dimension in mm



Footprint recommendation

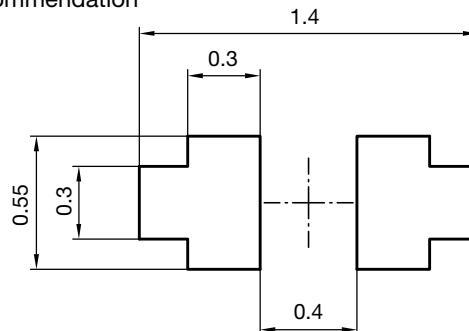

Document no.: S8-V-3906.04-059 (4)
Created - Date: 11-Jul-2018
Rev.5 - Date: 17-Sep-2021

23191

CARRIER TAPE DFN1006-2A

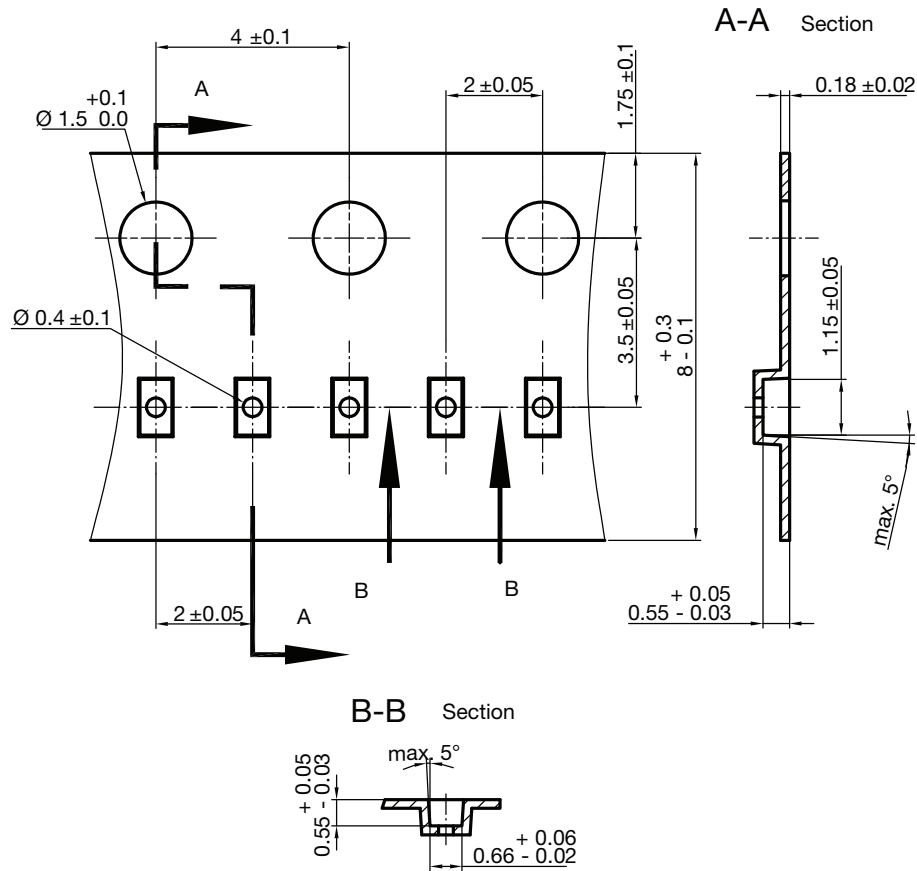

S8-V-3906.04-063 (4)
 created 28.10.2019

surface resistance: $10^5 - 10^{11} \frac{\text{OHMS}}{\text{SQ}}$
 Cumulative tolerances of 10 sprocket holes is $\pm 0.2 \text{ mm}$

ORIENTATION IN CARRIER TAPE DFN1006-2A

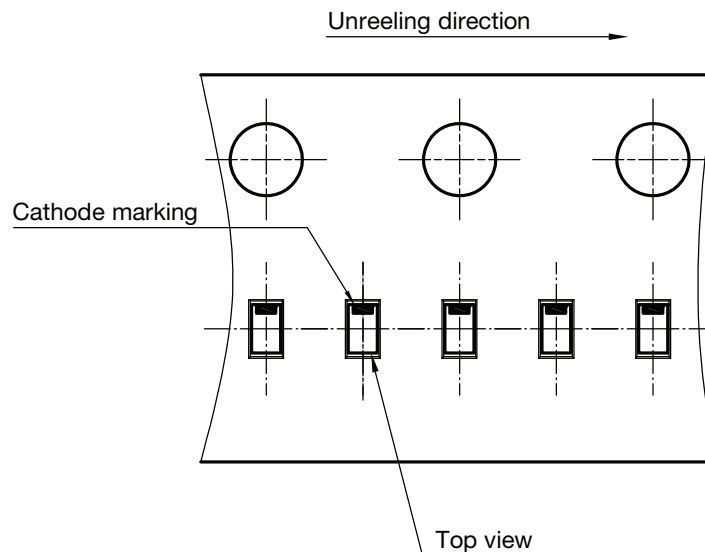

S8-V-3906.04-064 (4)
 created 28.10.2019



Disclaimer

ALL PRODUCT, PRODUCT SPECIFICATIONS AND DATA ARE SUBJECT TO CHANGE WITHOUT NOTICE TO IMPROVE RELIABILITY, FUNCTION OR DESIGN OR OTHERWISE.

Vishay Intertechnology, Inc., its affiliates, agents, and employees, and all persons acting on its or their behalf (collectively, "Vishay"), disclaim any and all liability for any errors, inaccuracies or incompleteness contained in any datasheet or in any other disclosure relating to any product.

Vishay makes no warranty, representation or guarantee regarding the suitability of the products for any particular purpose or the continuing production of any product. To the maximum extent permitted by applicable law, Vishay disclaims (i) any and all liability arising out of the application or use of any product, (ii) any and all liability, including without limitation special, consequential or incidental damages, and (iii) any and all implied warranties, including warranties of fitness for particular purpose, non-infringement and merchantability.

Statements regarding the suitability of products for certain types of applications are based on Vishay's knowledge of typical requirements that are often placed on Vishay products in generic applications. Such statements are not binding statements about the suitability of products for a particular application. It is the customer's responsibility to validate that a particular product with the properties described in the product specification is suitable for use in a particular application. Parameters provided in datasheets and / or specifications may vary in different applications and performance may vary over time. All operating parameters, including typical parameters, must be validated for each customer application by the customer's technical experts. Product specifications do not expand or otherwise modify Vishay's terms and conditions of purchase, including but not limited to the warranty expressed therein.

Hyperlinks included in this datasheet may direct users to third-party websites. These links are provided as a convenience and for informational purposes only. Inclusion of these hyperlinks does not constitute an endorsement or an approval by Vishay of any of the products, services or opinions of the corporation, organization or individual associated with the third-party website. Vishay disclaims any and all liability and bears no responsibility for the accuracy, legality or content of the third-party website or for that of subsequent links.

Except as expressly indicated in writing, Vishay products are not designed for use in medical, life-saving, or life-sustaining applications or for any other application in which the failure of the Vishay product could result in personal injury or death. Customers using or selling Vishay products not expressly indicated for use in such applications do so at their own risk. Please contact authorized Vishay personnel to obtain written terms and conditions regarding products designed for such applications.

No license, express or implied, by estoppel or otherwise, to any intellectual property rights is granted by this document or by any conduct of Vishay. Product names and markings noted herein may be trademarks of their respective owners.