

Low Capacitance, Single-Line ESD-Protection Diode in SOD-323

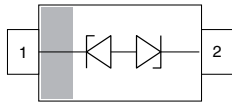

20503

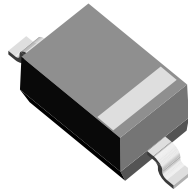

22756 SOD-323

MARKING (example only)

XYZ = type code (see table below)
bar = pin 1

LINKS TO ADDITIONAL RESOURCES

FEATURES

- For LIN-Bus applications
- Small SOD-323 package
- 1-line ESD-protection
- Working range: $\pm 26.5\text{ V}$
- Low leakage current $I_R < 0.05\ \mu\text{A}$
- Low load capacitance $C_D < 16\ \text{pF}$
- ESD-protection acc. IEC 61000-4-2
 $\pm 30\ \text{kV}$ contact discharge
 $\pm 30\ \text{kV}$ air discharge
- ESD capability according to AEC-Q101:
human body model: class H3B: $> 8\ \text{kV}$
- e3 - pins plated with tin (Sn)
- AEC-Q101 qualified available
- Material categorization: for definitions of compliance please see www.vishay.com/doc?99912

RoHS
COMPLIANT

ORDERING INFORMATION

PART NUMBER (EXAMPLE)	ENVIRONMENTAL AND QUALITY CODE				PACKAGING CODE		ORDERING CODE (EXAMPLE)
	AEC-Q101 QUALIFIED	RoHS-COMPLIANT + LEAD (Pb)-FREE TERMINATIONS		TIN PLATED	3K PER 7" REEL (8 mm TAPE)	10K PER 13" REEL (8 mm TAPE)	
		STANDARD	GREEN		15K/BOX = MOQ	10K/BOX = MOQ	
VLIN2626-02G	-	E	-	3	-08	-	VLIN2626-02G-E3-08
VLIN2626-02G	H	E	-	3	-08	-	VLIN2626-02GHE3-08
VLIN2626-02G	-	E	-	3	-	-18	VLIN2626-02G-E3-18
VLIN2626-02G	H	E	-	3	-	-18	VLIN2626-02GHE3-18

PACKAGE DATA

DEVICE NAME	PACKAGE NAME	TYPE CODE	WEIGHT	MOLDING COMPOUND FLAMMABILITY RATING	MOISTURE SENSITIVITY LEVEL	SOLDERING CONDITIONS
VLIN2626-02G	SOD-323	262	4.30 mg	UL 94 V-0	MSL level 1 (according J-STD-020)	Peak temperature max. 260 °C

ABSOLUTE MAXIMUM RATINGS

PARAMETER	TEST CONDITIONS	SYMBOL	VALUE	UNIT
Peak pulse current	$T_A = 25\ ^\circ\text{C}$; acc. IEC 61000-4-5; $t_p = 8/20\ \mu\text{s}$; single shot	I_{PPM}	4	A
Peak pulse power	$T_A = 25\ ^\circ\text{C}$; acc. IEC 61000-4-5; $t_p = 8/20\ \mu\text{s}$; single shot	P_{PP}	200	W
ESD immunity	Contact discharge acc. IEC 61000-4-2; $C = 150\ \text{pF}$, $R = 330\ \Omega$, $T_A = 25\ ^\circ\text{C}$	V_{ESD}	± 30	kV
	Air discharge acc. IEC 61000-4-2; $C = 150\ \text{pF}$, $R = 330\ \Omega$, $T_A = 25\ ^\circ\text{C}$		± 30	kV
ESD immunity	Contact discharge acc. ISO 10605; $C = 330\ \text{pF}$, $R = 330\ \Omega$, $T_A = 25\ ^\circ\text{C}$	V_{ESD}	± 30	kV
	Air discharge acc. ISO 10605; $C = 330\ \text{pF}$, $R = 330\ \Omega$, $T_A = 25\ ^\circ\text{C}$		± 30	kV
Operating temperature	Junction temperature	T_J	-55 to +150	°C
Storage temperature		T_{STG}	-55 to +150	°C

ELECTRICAL CHARACTERISTICS ($T_{amb} = 25\text{ }^{\circ}\text{C}$, unless otherwise specified)						
PARAMETER	TEST CONDITIONS / REMARKS	SYMBOL	MIN.	TYP.	MAX.	UNIT
Protection paths	Number of lines which can be protected	$N_{channel}$	-	-	1	lines
Reverse stand-off voltage	Max. reverse working voltage	V_{RWM}	-	-	26.5	V
Reverse voltage	At $I_R = 0.05\text{ }\mu\text{A}$	V_R	26.5	-	-	V
Reverse current	At $V_{RWM} = 26.5\text{ V}$	I_R	-	-	0.05	μA
Reverse breakdown voltage	At $I_R = 1\text{ mA}$	V_{BR}	28	30	32	V
Reverse clamping voltage	At $I_{PP} = 1\text{ A}$; $t_p = 8/20\text{ }\mu\text{s}$	V_C	-	32	40	V
	At $I_{PP} = I_{PPM} = 4\text{ A}$; $t_p = 8/20\text{ }\mu\text{s}$	V_C	-	39	50	V
Capacitance	At $V_R = 0\text{ V}$, $f = 1\text{ MHz}$	C_D	-	13.5	16	pF

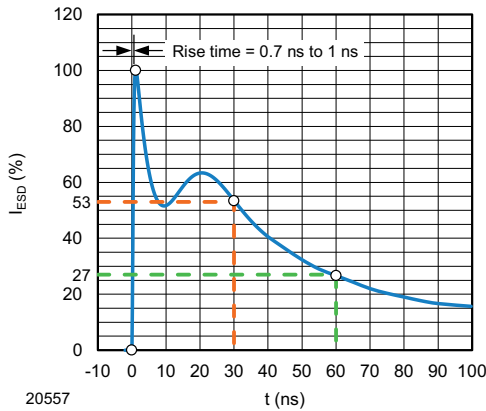
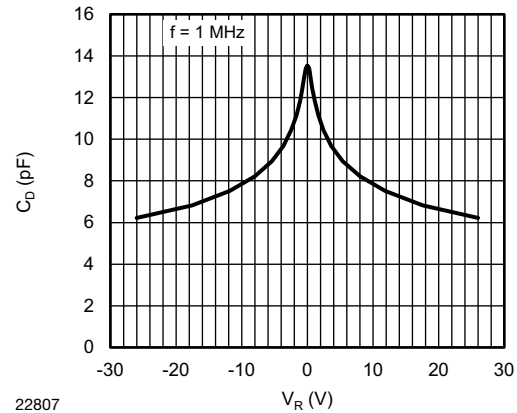
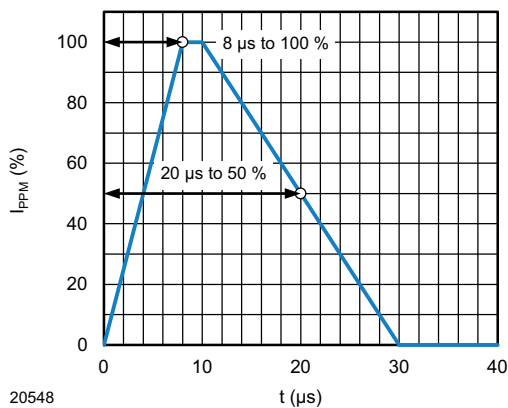
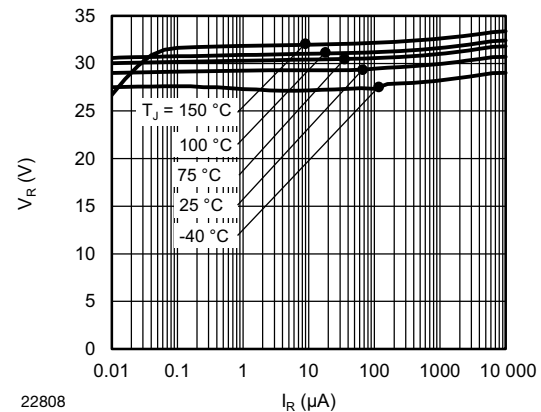
TYPICAL CHARACTERISTICS ($T_{amb} = 25\text{ }^{\circ}\text{C}$, unless otherwise specified)

 Fig. 1 - ESD Discharge Current Wave Form acc. IEC 61000-4-2 (330 Ω / 150 pF)

 Fig. 3 - Typical Capacitance C_D vs. Reverse Voltage V_R

 Fig. 2 - 8/20 μs Peak Pulse Current Wave Form acc. IEC 61000-4-5

 Fig. 4 - Typical Reverse Voltage V_R vs. Reverse Current I_R

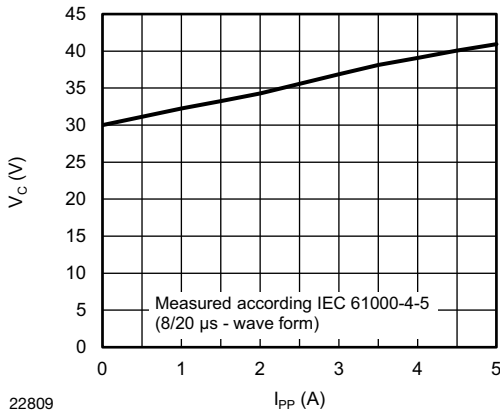

Fig. 5 - Typical Peak Clamping Voltage V_C vs. Peak Pulse Current I_{PP}

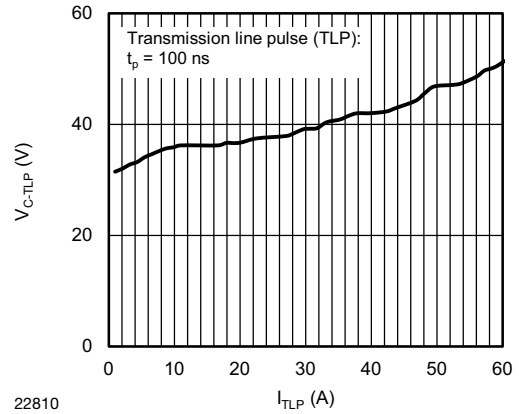
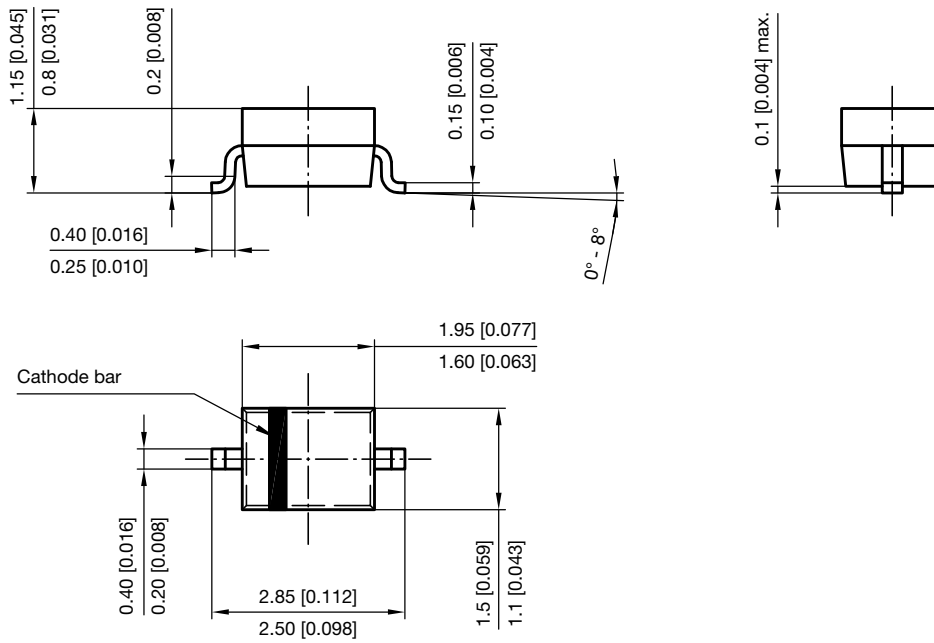
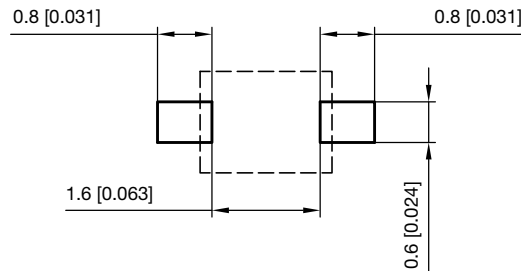

Fig. 6 - Typical Clamping Voltage V_{C-TLP} vs. Pulse Current I_{TLP}

PACKAGE DIMENSIONS in millimeters (inches) **SOD-323**



Footprint recommendation:



Document no.: S8-V-3910.02-001 (4)
 Created - Date: 24.August.2004
 Rev. 6 - Date: 23.Sept.2016
 22771

CARRIER TAPE SOD-323

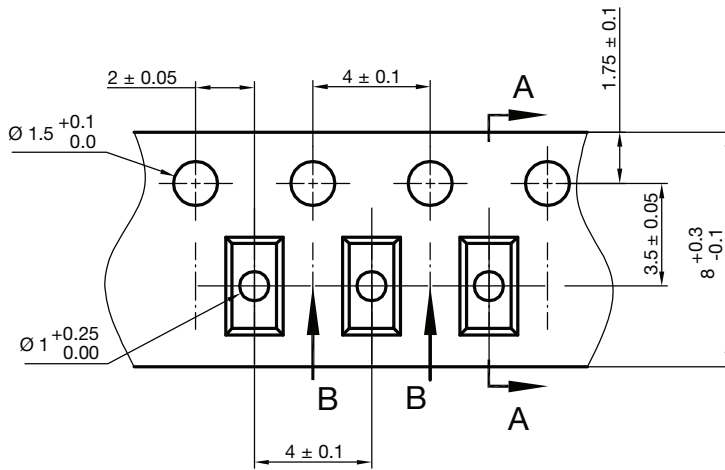

A-A Section

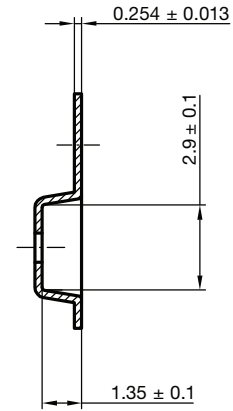

B-B Section

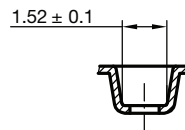

Document no.: S8-V-3717.07-002 (4)
 Created - Date: 09. Feb. 2010
 22824

ORIENTATION IN CARRIER TAPE SOD-323

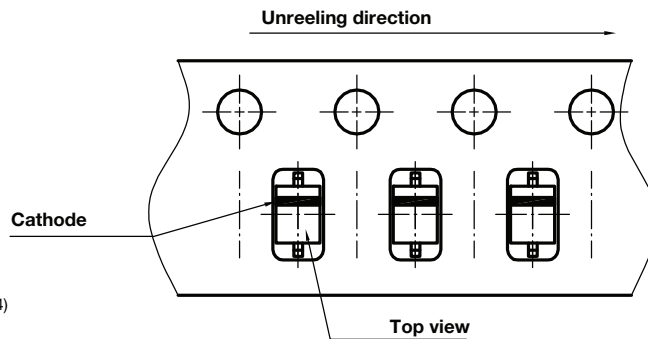

Document no.: S8-V-3717.07-003 (4)
 Created - Date: 09. Feb. 2010
 22772



Disclaimer

ALL PRODUCT, PRODUCT SPECIFICATIONS AND DATA ARE SUBJECT TO CHANGE WITHOUT NOTICE TO IMPROVE RELIABILITY, FUNCTION OR DESIGN OR OTHERWISE.

Vishay Intertechnology, Inc., its affiliates, agents, and employees, and all persons acting on its or their behalf (collectively, "Vishay"), disclaim any and all liability for any errors, inaccuracies or incompleteness contained in any datasheet or in any other disclosure relating to any product.

Vishay makes no warranty, representation or guarantee regarding the suitability of the products for any particular purpose or the continuing production of any product. To the maximum extent permitted by applicable law, Vishay disclaims (i) any and all liability arising out of the application or use of any product, (ii) any and all liability, including without limitation special, consequential or incidental damages, and (iii) any and all implied warranties, including warranties of fitness for particular purpose, non-infringement and merchantability.

Statements regarding the suitability of products for certain types of applications are based on Vishay's knowledge of typical requirements that are often placed on Vishay products in generic applications. Such statements are not binding statements about the suitability of products for a particular application. It is the customer's responsibility to validate that a particular product with the properties described in the product specification is suitable for use in a particular application. Parameters provided in datasheets and / or specifications may vary in different applications and performance may vary over time. All operating parameters, including typical parameters, must be validated for each customer application by the customer's technical experts. Product specifications do not expand or otherwise modify Vishay's terms and conditions of purchase, including but not limited to the warranty expressed therein.

Hyperlinks included in this datasheet may direct users to third-party websites. These links are provided as a convenience and for informational purposes only. Inclusion of these hyperlinks does not constitute an endorsement or an approval by Vishay of any of the products, services or opinions of the corporation, organization or individual associated with the third-party website. Vishay disclaims any and all liability and bears no responsibility for the accuracy, legality or content of the third-party website or for that of subsequent links.

Except as expressly indicated in writing, Vishay products are not designed for use in medical, life-saving, or life-sustaining applications or for any other application in which the failure of the Vishay product could result in personal injury or death. Customers using or selling Vishay products not expressly indicated for use in such applications do so at their own risk. Please contact authorized Vishay personnel to obtain written terms and conditions regarding products designed for such applications.

No license, express or implied, by estoppel or otherwise, to any intellectual property rights is granted by this document or by any conduct of Vishay. Product names and markings noted herein may be trademarks of their respective owners.