

Click to
ORDER
samples

AM100W-NZ

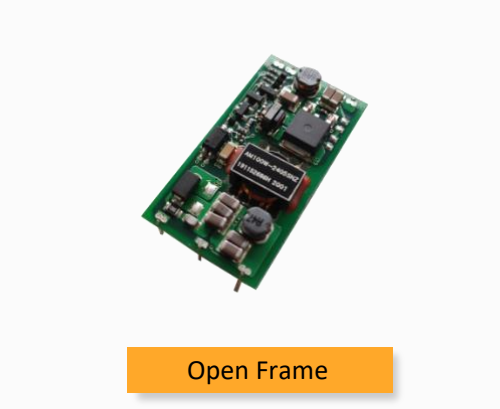

Open Frame

The AM100W-NZ series is designed to offer an ultra-thin solution to customers with designs that have challenging height considerations. The AM100W-NZ series is available in both SIP and DIP packages with open frame and metal case options. The total height of 0.24inches (6.1mm) for the Dual inline Package offers significant space optimization when compared to typical 10W DIP products with approximately twice the height (~0.4inches). In addition, the AM100W-NZ offers an impressive 500VAC/1500VDC isolation with a 4:1 input voltage range of 9-36VDC. It is also designed with input under-voltage protection, output over-voltage, over-current, short circuit protection, which enable the AM100W-NZ series to be used in a variety of application related to industrial control, instrumentation and communication equipment.

Features



- Wide 4:1 Input Range: 9VDC – 36VDC
- Operating Temp: -40 °C to +85 °C
- Low ripple & noise, up to 100mV(p-p) max
- Efficiency up to 88%
- Adjustable output voltage
- Output short circuit, over current protection, over voltage protection
- Regulated Output

Summary

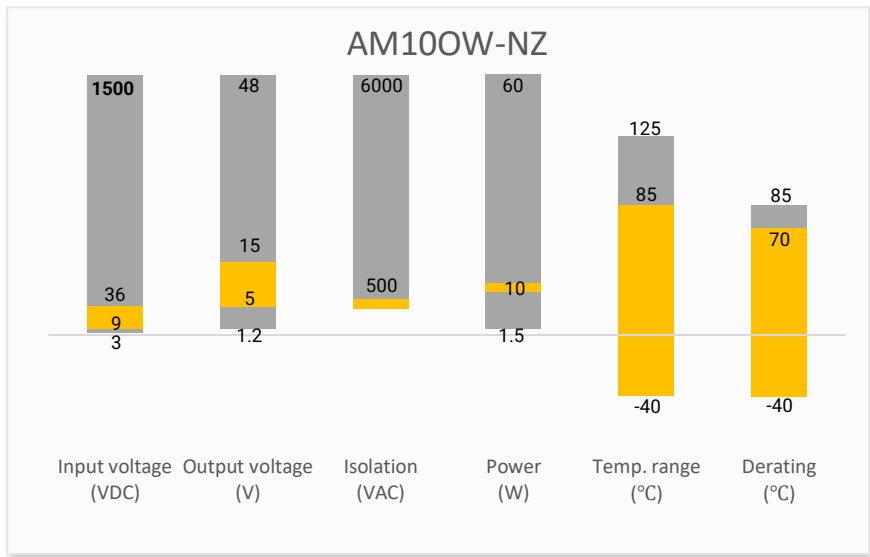

Training

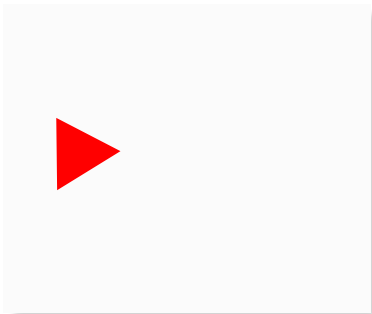

Product Training Video
(click to open)



Application Notes

Applications



Power Grid



Industrial



Telecom



Instrumentation

Models & Specifications

Single Output

Model	Input Voltage (VDC)	Output Voltage (VDC)	Input Current Max (mA)		Output Current Max (mA)	Maximum Capacitive Load (μF)	Efficiency (%) Full Load
			No Load	Full Load			
AM100W-2405SNZ	24 (9 ~ 36)	5	40	508	2000	2200	84
AM100W-2412SNZ	24 (9 ~ 36)	12	12	490	833	680	87
AM100W-2415SNZ	24 (9 ~ 36)	15	15	485	667	470	88

The standard part number is for DIP and open-frame package;

With adding suffix “-M” for DIP package with metal case (E.g. AM100W-1205SNZ-M is for 5V model with DIP pin type and metal case);

With adding suffix “-L” for SMD and open-frame package (E.g. AM100W-1205SNZ-L is for 5V model with SMD pin type and open frame);

With adding suffix “-LM” for SMD package with metal case (E.g. AM100W-1205SNZ-LM is for 5V model with SMD pin type and metal case).

Input Specification

Parameters	Conditions	Typical	Maximum	Units
Voltage range	See models table			VDC
Filter	Pi filter			
Absolute maximum rating	1 sec. max		50	VDC
Reflected ripple current		40		mA pk-pk
Start-up voltage	Nominal 12V input models		9	VDC
Input under voltage lockout	Nominal 12V input models	6.5		VDC
On/Off Control *	ON – 0 to 0.3Vdc, pulled low to GND; OFF – 2.4~12Vdc, pulled high or open, idle current 6mA typ.			

* The Ctrl pin voltage is referenced to input GND.

Isolation Specification

Parameters	Conditions	Typical	Maximum	Units
Tested I/O voltage	60 sec, 5mA max	500		VAC
	60 sec, 1mA max	1500		VDC
Tested case to I/O voltage	60 sec, 5mA max, for metal case models	500		VAC
	60 sec, 1mA max, for metal case models	1500		VDC
Resistance	500Vdc	≥ 100		MΩ
Capacitance	I/O capacitance at 100KHz/0.1V	1000		pF

Output Specification				
Parameters	Conditions	Typical	Maximum	Units
Voltage accuracy	0 ~ 100% load	± 1	± 3	%
Line regulation	Full load	± 0.2	± 0.5	%
Load regulation	5 ~ 100% load	± 0.5	± 1	%
Over voltage protection			160	% Vout
Over current protection		140	200	% Iout
Short circuit protection	Continuous, Auto recovery			
Temperature coefficient	Full load		± 0.03	%/°C
Ripple & Noise*	20MHz bandwidth, 5 ~ 100% load	50	100	mV pk-pk
Transient recovery time	25% load step change	300	500	µS
Transient response deviation	25% load step change	±3	±5	%

* Ripple and Noise are measured at 20MHz bandwidth by using a 1µF (M/C) and 10µF (E/C) parallel capacitor and typical input with full load

General Specifications				
Parameters	Conditions	Typical	Maximum	Units
Switching frequency	100% load	350		KHz
Operating temperature	See derating graph	-40 to +85		°C
Storage temperature		-55 to +125		°C
Reflow soldering temperature	Peak temp ≤ 245°C, 60 sec max at 217°C, please refer to IPC/JEDEC J-STD-020D.1.			
Soldering temperature	1.5mm from case 10 sec max		300	°C
Cooling	Free air convection (20 LFM)			
Humidity	Non-condensing		95	% RH
Case material	Aluminum alloy			
Vibration	10-150Hz, 5G, 90min. along X, Y and Z			
Weight	Open-frame models	5.7		g
	Metal case models	6.7		
Dimensions (L x W x H)	Standard DIP and open-frame package	1.54 x 0.82 x 0.24 inches, 39.20 x 20.80 x 6.10mm		
	Optional SMD and open-frame package	1.63 x 0.82 x 0.25 inches, 41.40 x 20.80 x 6.30mm		
	Optional DIP package with metal case	1.58 x 0.87 x 0.27 inches, 40.20 x 22.00 x 6.80mm		
	Optional SMD package with metal case	1.63 x 0.87 x 0.28 inches, 41.40 x 22.00 x 7.00mm		
MTBF	> 1 000 000 hrs (MIL-HDBK -217F, t=+25°C) / Full Load			

Safety Specifications		
Parameters		
Standards	Designed to meet UL/IEC/EN 62368	
	EMC - Conducted and radiated emission	EN55032, CLASS A EN55032, CLASS B with recommended circuit
	Electrostatic Discharge Immunity	IEC 61000-4-2, Criteria B
	RF, Electromagnetic Field Immunity	IEC 61000-4-3, Criteria A
	Electrical Fast Transient/Burst Immunity	IEC 61000-4-4, Criteria B with recommended circuit
	Surge Immunity	IEC 61000-4-5, Criteria B with recommended circuit
	RF, Conducted Disturbance Immunity	IEC 61000-4-6, Criteria A

Note: The case grounding connection to the ground is strongly suggested for the EMC consideration (For the models with optional "-M" only)

Derating

5V output model
Free air Convection

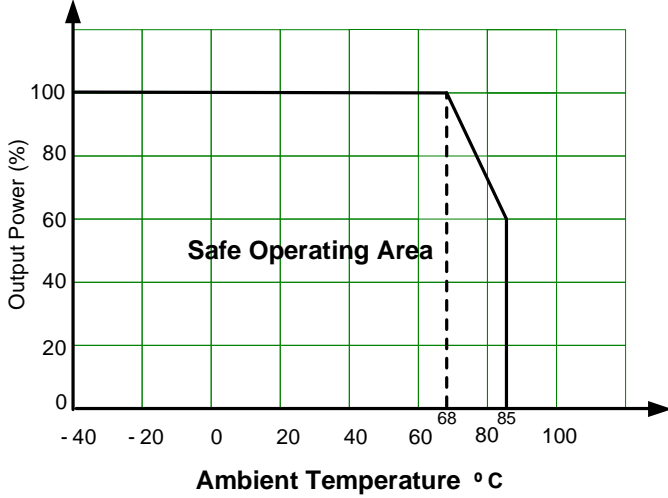

Others
Free air Convection

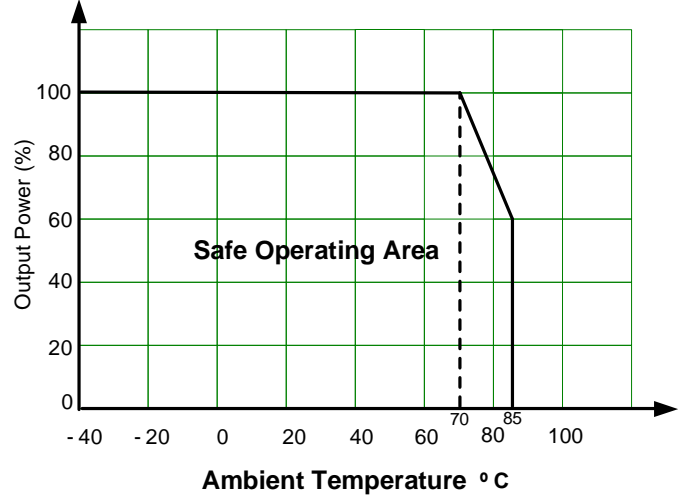

Typical Application Circuit

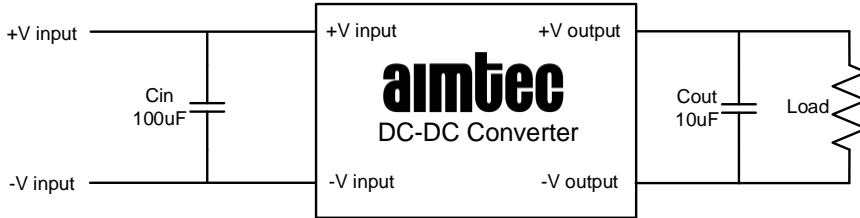

EMC Recommended Circuit

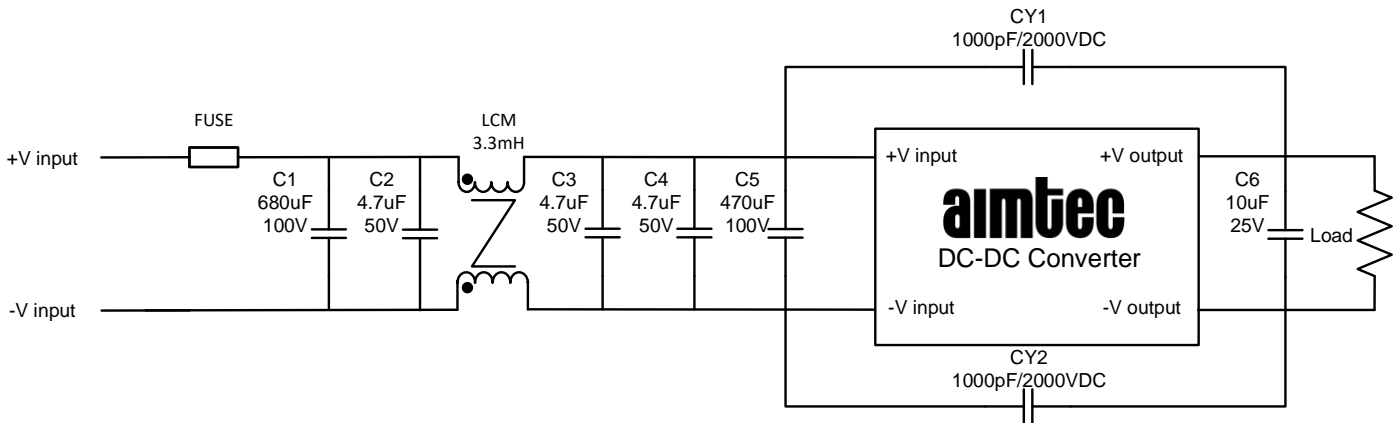

Fuse : Choose according to actual input current.

Note: The package with case model, the case should be connected to input pin GND when testing EMC performance.

Dimensions

Standard DIP and open-frame package models

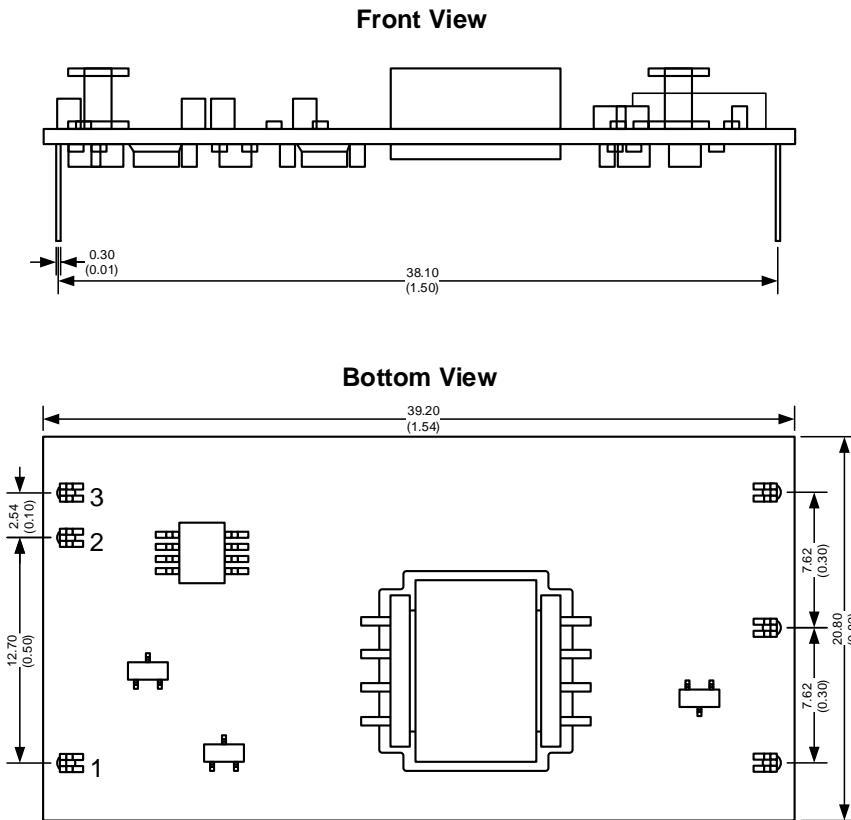

Notes:
All dimensions are typical in millimeters (inches).
Pin section tolerance : ± 0.1 (± 0.004)
Stand-off tolerance ± 0.50 (± 0.02)

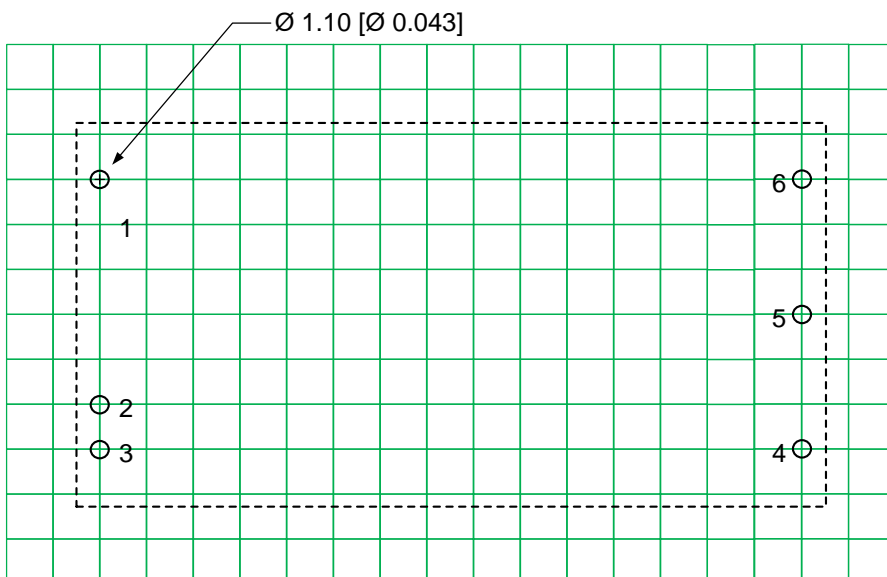

Note : Grid 2.54*2.54 mm

Pin Out Specifications	
Pin	Single
1	+V Input
2	Ctrl
3	-V Input
4	-V Output
5	Trim
6	+V Output

Optional DIP package with metal case models

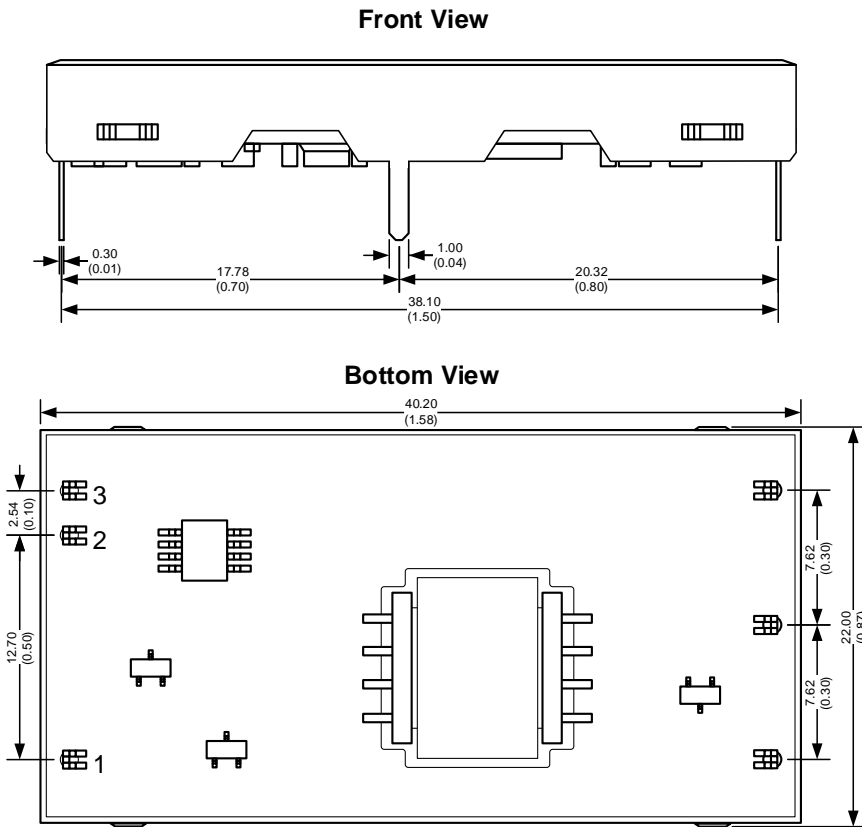

Notes:

All dimensions are typical in millimeters (inches).

Pin section tolerance : ± 0.1 (± 0.004)

Stand-off tolerance ± 0.50 (± 0.02)

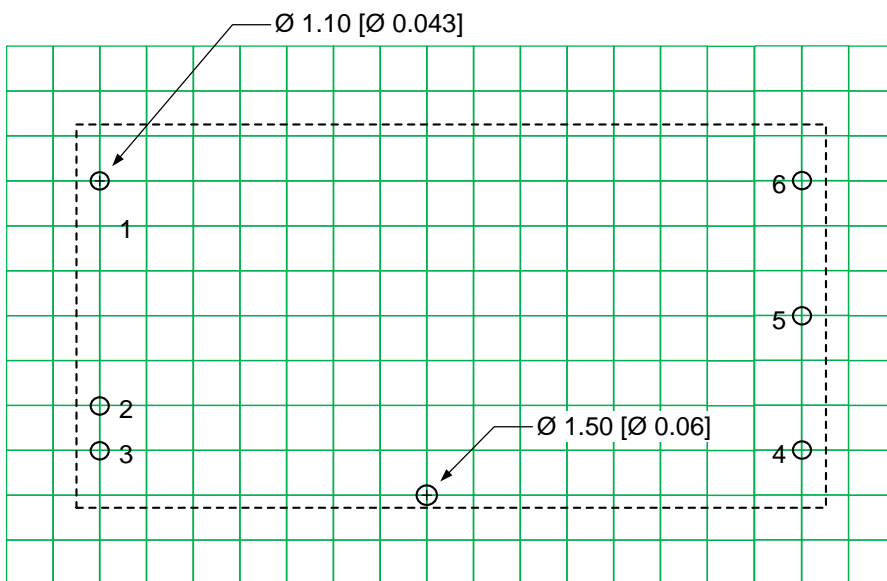

Note : Grid 2.54*2.54 mm

Pin Out Specifications	
Pin	Single
1	-V Input
2	Trim
3	NC
4	+V Output
5	-V Output
6	+V Input

Optional SMD and open-frame package models

Front View

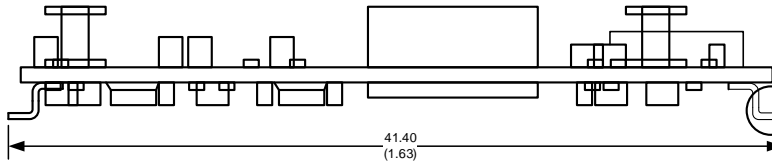

Right View

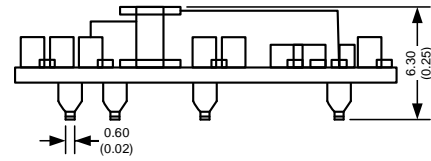

Bottom View

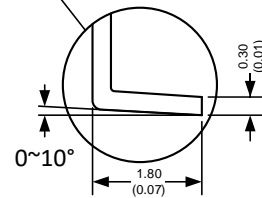
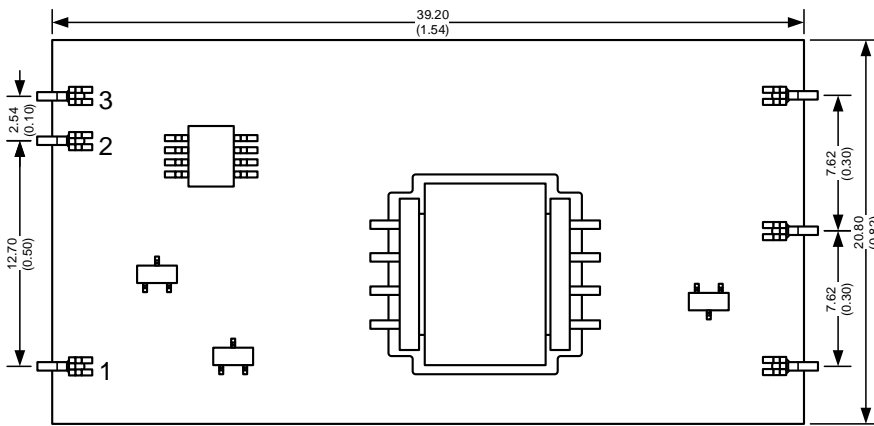

Notes:

All dimensions are typical in millimeters (inches).
Pin section tolerance : ± 0.1 (± 0.004)
Stand-off tolerance ± 0.50 (± 0.02)

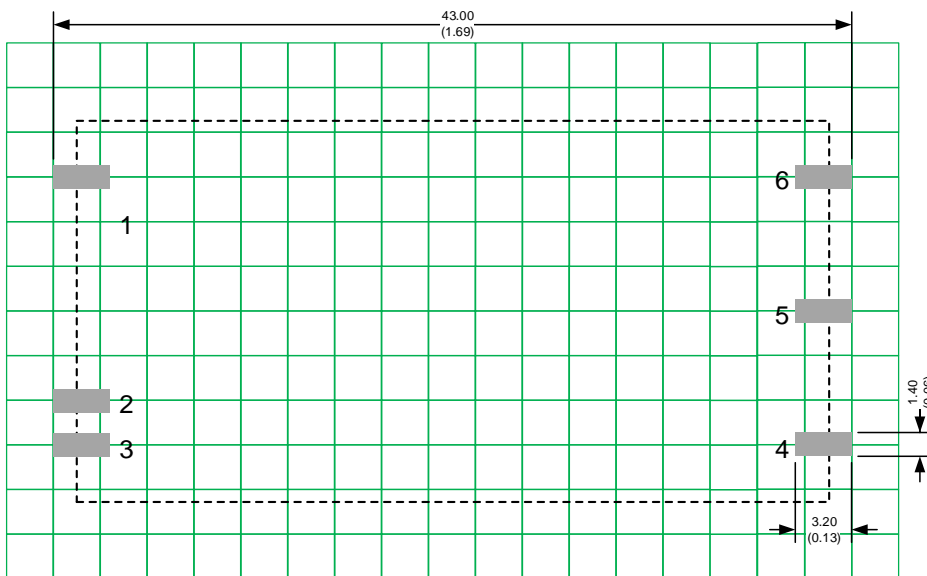

Note : Grid 2.54*2.54 mm

Pin Out Specifications	
Pin	Single
1	+V Input
2	Ctrl
3	-V Input
4	-V Output
5	Trim
6	+V Output

Optional SMD package with metal case models

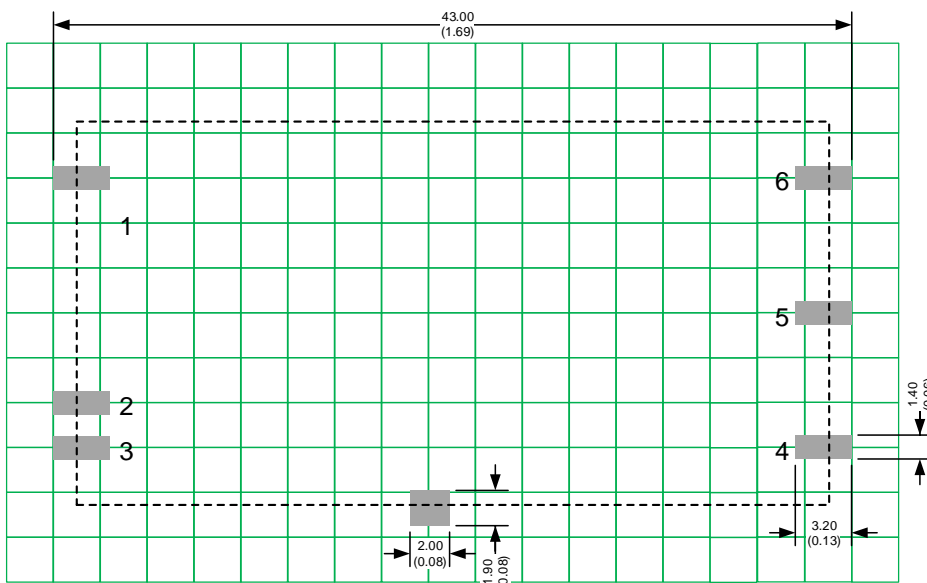
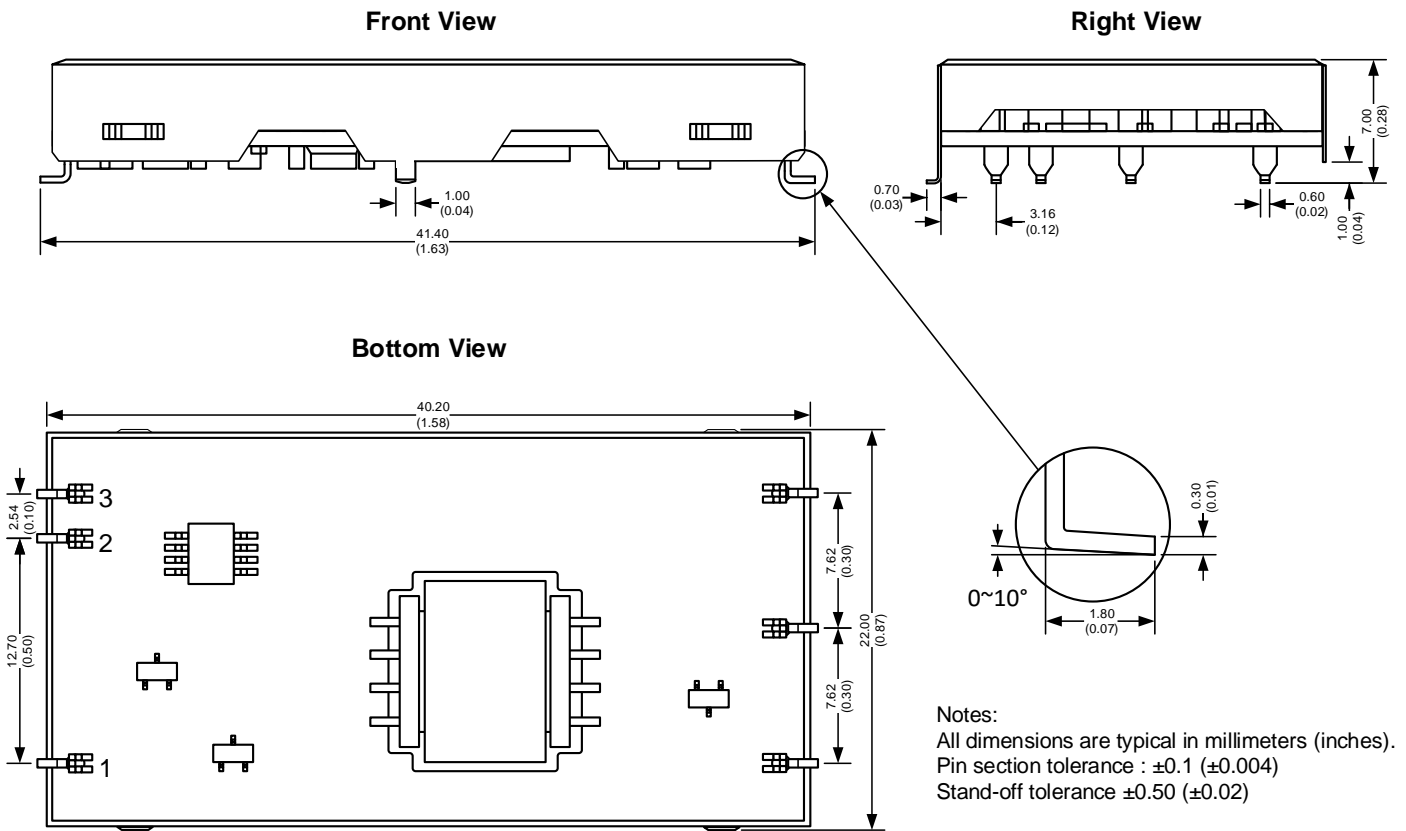

Note : Grid 2.54*2.54 mm

Pin Out Specifications	
Pin	Single
1	+V Input
2	Ctrl
3	-V Input
4	-V Output
5	Trim
6	+V Output

Trimming



Output voltage can be externally trimmed by utilizing the methods as shown below

Fixed Resistor

Variable Potentiometer

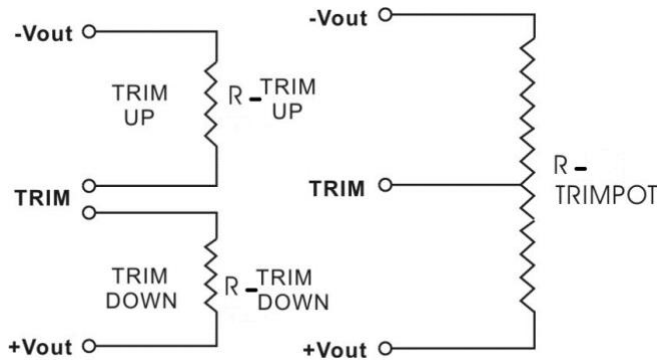

Leave open if not used.

AM100W-2405SNZ(-M/-L/-LM)

Trim down %	1	2	3	4	5	6	7	8	9	10
Vout (VDC)	4.950	4.900	4.850	4.800	4.750	4.700	4.650	4.647	4.744	4.642
Rt down (KΩ)	49.906	28.833	17.748	10.910	6.272	2.918	0.380	0.248	5.813	0.031
Trim up %	1	2	3	4	5	6	7	8	9	10
Vout (VDC)	5.062	5.100	5.150	5.200	5.250	5.300	5.350	5.400	5.450	5.500
Rt up (KΩ)	7160.000	173.344	67.562	37.868	23.884	15.750	10.430	6.680	3.893	1.742

AM100W-2412SNZ(-M/-L/-LM)

Trim down %	1	2	3	4	5	6	7	8	9	10
Vout (VDC)	11.880	11.760	11.640	11.520	11.400	11.280	11.160	11.040	10.920	10.800
Rt down (KΩ)	478.092	283.452	194.527	143.585	110.573	87.442	70.332	57.164	46.716	38.223
Trim up %	1	2	3	4	5	6	7	8	9	10
Vout (VDC)	12.120	12.240	12.360	12.480	12.600	12.720	12.840	12.865	12.890	12.915
Rt up (KΩ)	688.435	140.920	65.879	36.075	20.077	10.095	3.274	2.116	1.030	0.009

AM100W-2415SNZ(-M/-L/-LM)

Trim down %	1	2	3	4	5	6	7	8	9	10
Vout (VDC)	14.850	14.700	14.550	14.400	14.250	14.100	13.950	13.800	13.650	13.500
Rt down (KΩ)	623.045	395.763	285.907	221.156	178.462	148.196	125.620	108.134	94.191	82.813
Trim up %	1	2	3	4	5	6	7	8	9	10
Vout (VDC)	15.150	15.300	15.450	15.600	15.750	15.900	16.050	16.200	16.350	16.500
Rt up (KΩ)	1859.550	199.069	98.516	62.236	43.530	32.118	24.431	18.899	14.729	11.473

NOTE: 1. Datasheets are updated as needed and as such, specifications are subject to change without notice. Once printed or downloaded, datasheets are no longer controlled by Aimtec; refer to www.aimtec.com for the most current product specifications. **2.** Product labels shown, including safety agency certifications on labels, may vary based on the date manufactured. **3.** Mechanical drawings and specifications are for reference only. **4.** All specifications are measured at an ambient temperature of 25°C, humidity<75%, nominal input voltage and at rated output load unless otherwise specified. **5.** Aimtec may not have conducted destructive testing or chemical analysis on all internal components and chemicals at the time of publishing this document. CAS numbers and other limited information are considered proprietary and may not be available for release. **6.** This product is not designed for use in critical life support systems, equipment used in hazardous environments, nuclear control systems or other such applications which necessitate specific safety and regulatory standards other the ones listed in this datasheet. **7.** Warranty is in accordance with Aimtec's standard Terms of Sale available at www.aimtec.com.