

RSMN SERIES

Compact Multipurpose Type Compatible with High-Voltage Pulse



FEATURES

- EMC filter equipped with an amorphous core as the common mode coil core for the RSHN series, which helps prevent device errors, and can also withstand current saturation.
- Self-tightening screws and an open/close type cover make wiring work easier.
- Optional low-leakage characteristic type and DIN rail installation compatible type are also available.

SAFETY STANDARDS

UL1283	UL File No. E62388
CSA C22.2 No.8	CSA File No. LR76849 (Up to 30A)
EN60939	Licence Ref. No. SE/07115-3

PRODUCT IDENTIFICATION

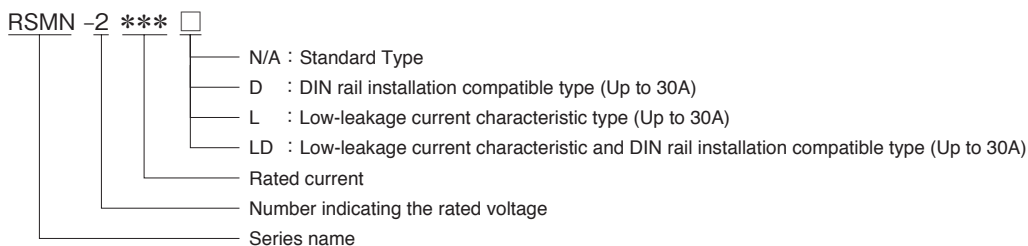

CONFORMITY TO RoHS Directive

CIRCUIT DIAGRAMS

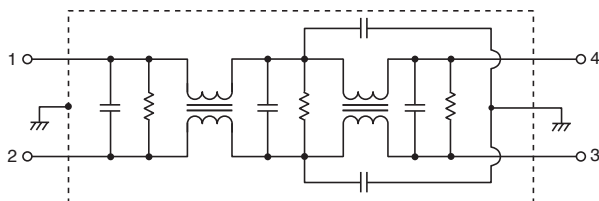

ELECTRICAL CHARACTERISTICS

Part No.	Rated voltage (AC/DC)	Rated current (AC/DC)	Withstand voltage	Insulation resistance	Leakage current	Operating temperature range	With derating over	DC resistance (mΩ)	Attenuation frequency range (MHz)			Weight (g)
									Common mode		Differential mode	
									at 25dB	at 20dB	at 25dB	
RSMN-2003	250V	3A	AC.2500V 60s [Between line to ground]	100MΩ min. [DC.500V/ 1min]	1.0mA max. [250V/60Hz]	-25 to +85°C	55°C	350 max.	0.1 to 30	-	0.1 to 30	190
RSMN-2006		6A						140 max.	-	0.1 to 30	0.2 to 30	240
RSMN-2010		10A						60 max.	0.2 to 30	-	0.2 to 30	240
RSMN-2016		16A						35 max.	0.2 to 30	-	0.3 to 30	350
RSMN-2020		20A						22 max.	0.3 to 20	-	0.4 to 30	350
RSMN-2030		30A						12 max.	0.4 to 20	-	0.6 to 30	350
RSMN-2040		40A						10 max.	0.3 to 30	-	0.1 to 30	960
RSMN-2050		50A						8 max.	0.4 to 30	-	0.3 to 30	960
RSMN-2060		60A						6 max.	0.5 to 30	-	0.3 to 30	960

Part No.	Rated voltage (AC/DC)	Rated current (AC/DC)	Withstand voltage	Insulation resistance	Leakage current	Operating temperature range	With derating over	DC resistance (mΩ)	Attenuation frequency range (MHz)			Weight (g)
									Common mode		Differential mode	
									at 25dB	at 10dB	at 25dB	
RSMN-2003L	250V	3A	AC.2500V 60s [Between line to ground]	100MΩ min. [DC.500V/ 1min]	100μA max. [250V/60Hz]	-25 to +85°C	55°C	350 max.	0.3 to 30	-	0.2 to 30	190
RSMN-2006L		6A						140 max.	0.4 to 20	-	0.2 to 30	240
RSMN-2010L		10A						60 max.	0.7 to 20	-	0.3 to 30	240
RSMN-2016L		16A						35 max.	0.7 to 20	-	0.3 to 30	350
RSMN-2020L		20A						22 max.	-	0.6 to 20	0.3 to 30	350
RSMN-2030L		30A						12 max.	-	1 to 20	0.4 to 30	350

DERATING GRAPH

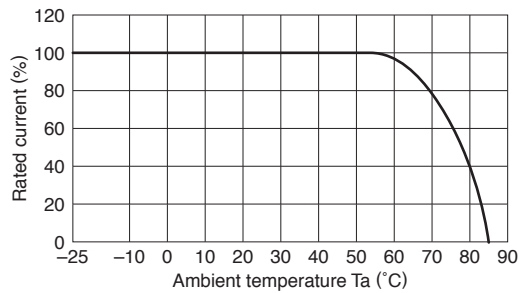

MECHANICAL

RSMN-2003/2006/2010/2016/2020/2030

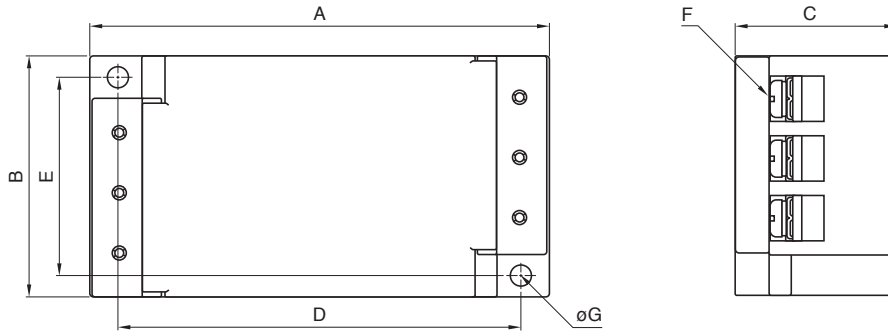

RSMN-2040/2050/2060

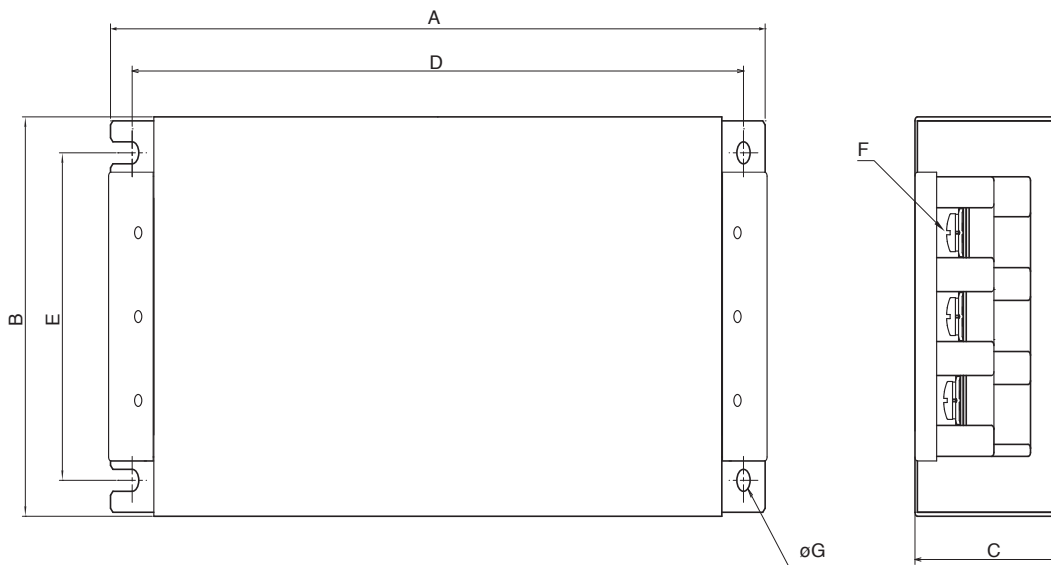

Dimensions in mm

Part No.	A	B	C	D	E	F	ϕG	Recommended clamping torque
RSMN-2003	98	52	35	86	43	M4	4.5	1.27N · m
RSMN-2006								
RSMN-2010								
RSMN-2016	127	52	35	115	43	M4	4.5	
RSMN-2020								
RSMN-2030								
RSMN-2040	272	100	60	254	82	M5	5.5	2.5N · m
RSMN-2050								
RSMN-2060								

RSMN-2003D/2006D/2010D

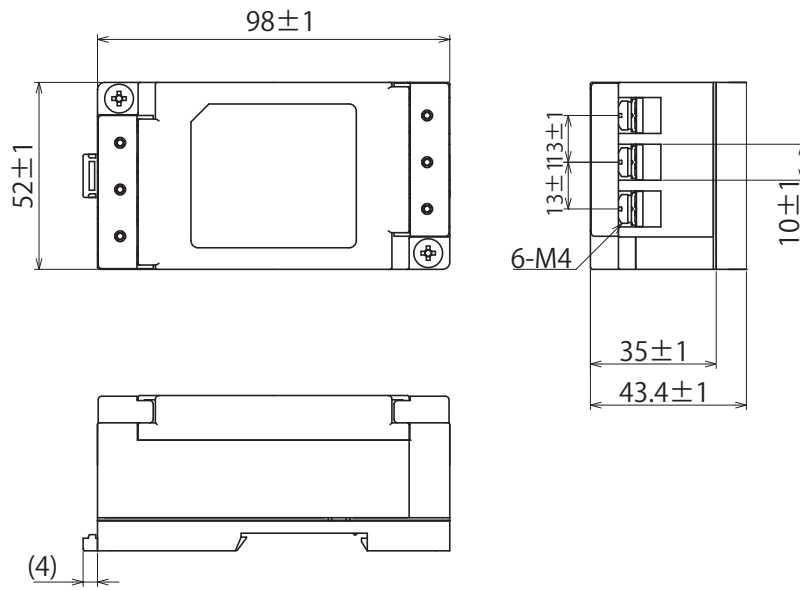

RSMN-2016D/2020D/2030D

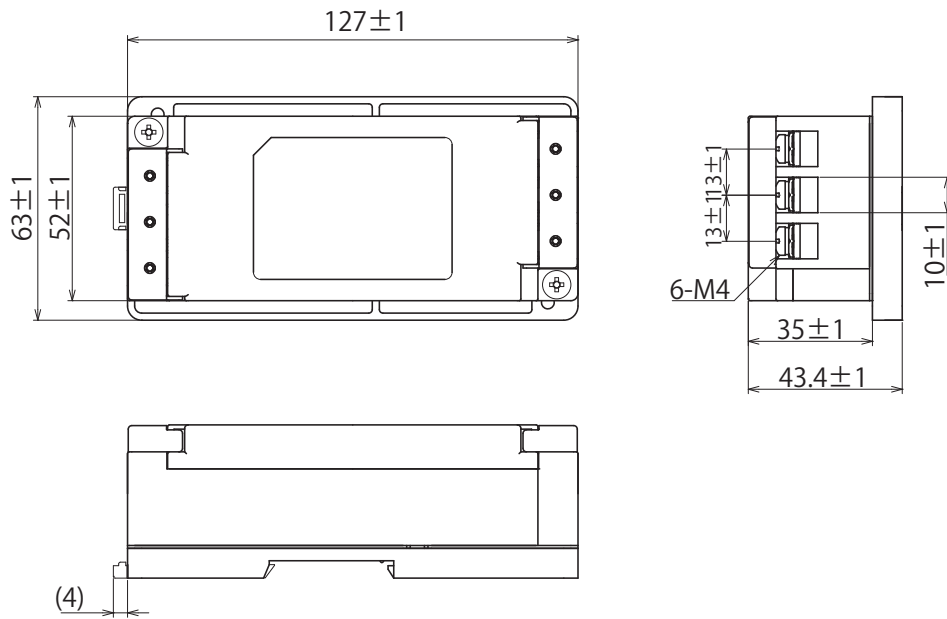

Dimensions in mm

*Please see the next page: "Precautions of DIN rail mounting".

Precautions of DIN rail mounting

When installing on a DIN rail, secure a space with a depth of 14 mm or more from the top of the rail. If there is no depth space, the tip of the DIN attachment and the installation surface may interfere and it may not be possible to install it.

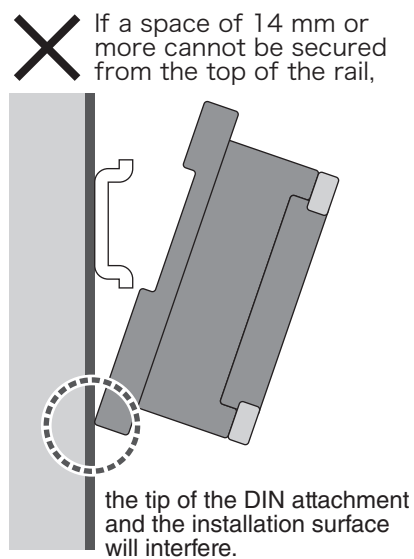
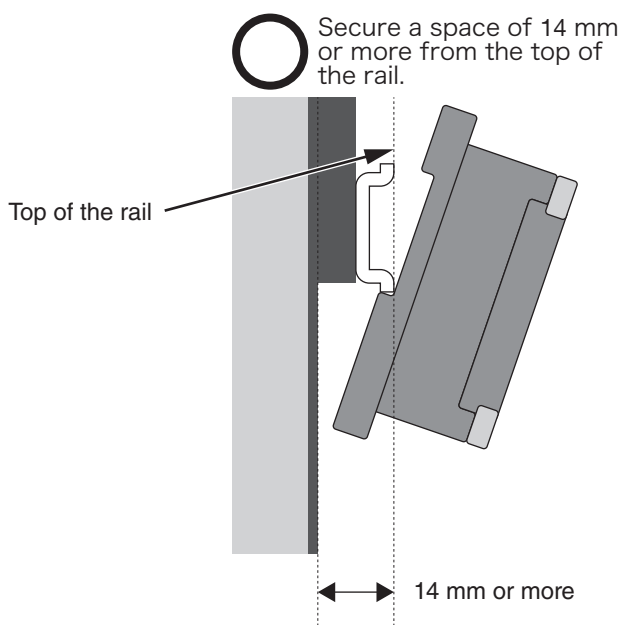

ATTENUATION vs. FREQUENCY CHARACTERISTICS

RSMN-2003

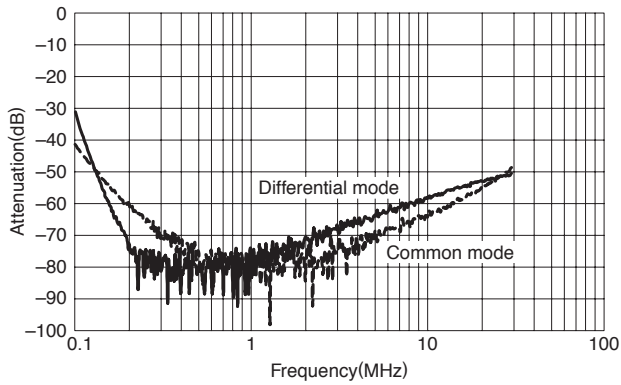

RSMN-2006

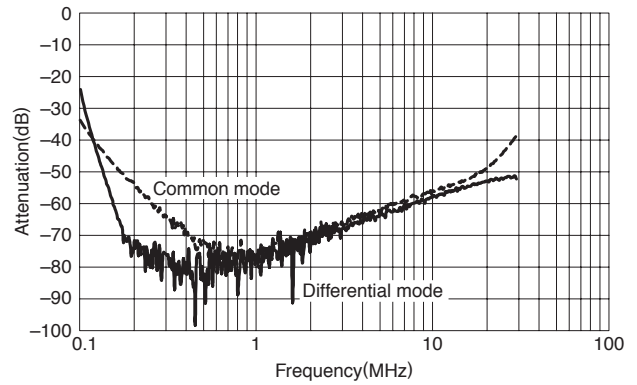

RSMN-2010

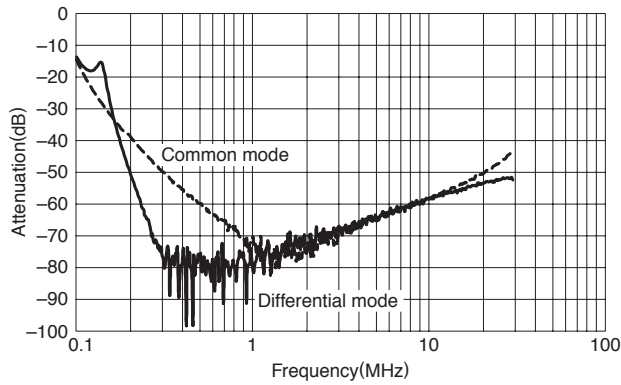

RSMN-2016

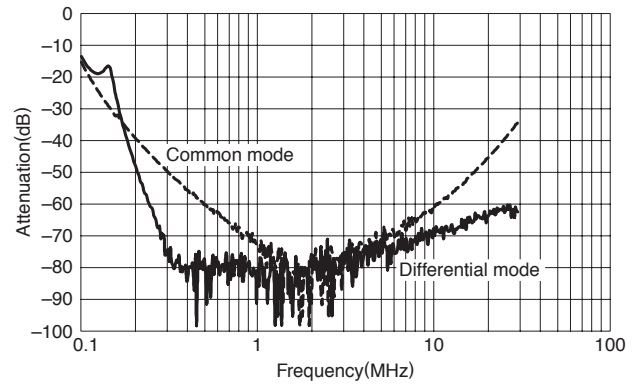

RSMN-2020

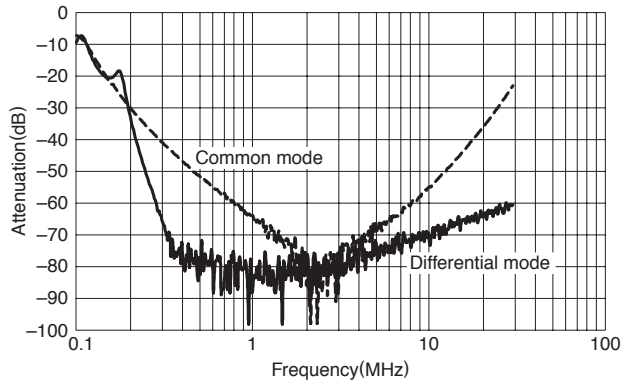

RSMN-2030

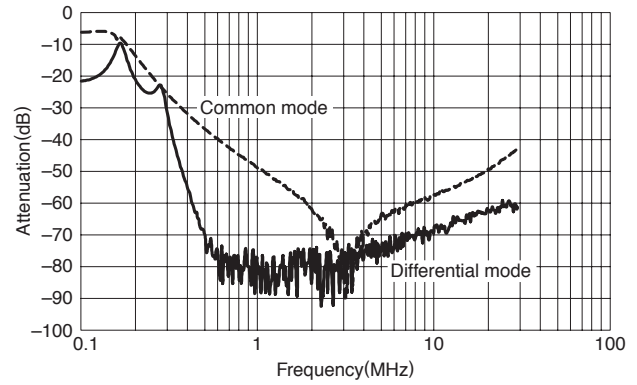

RSMN-2040

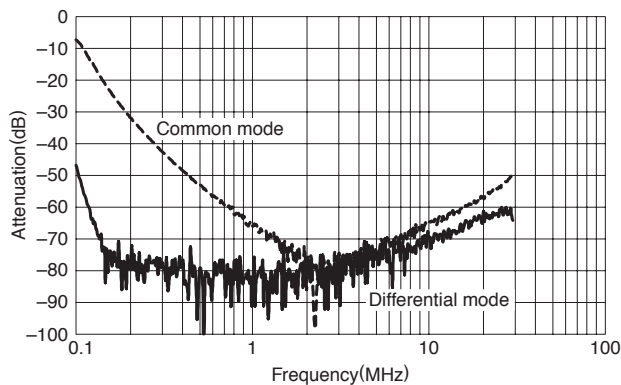

RSMN-2050

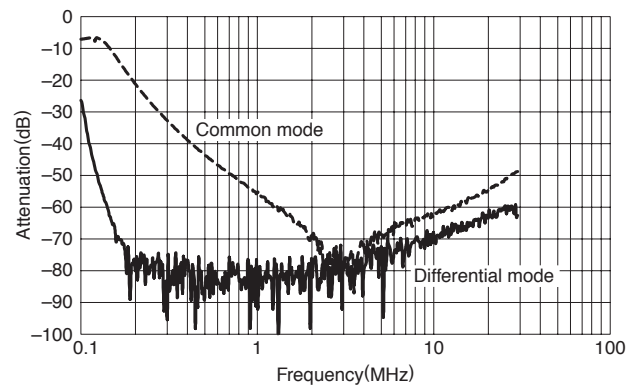

RSMN-2060

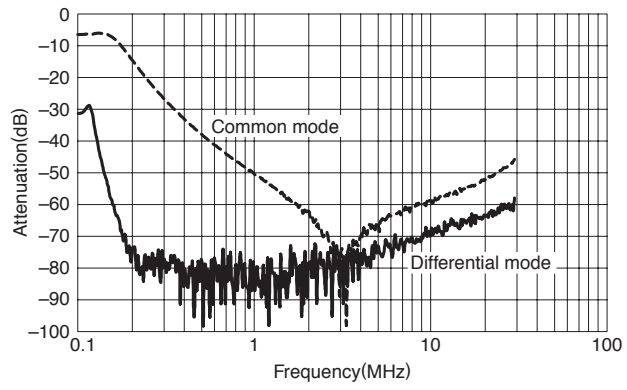

RSMN-2003L

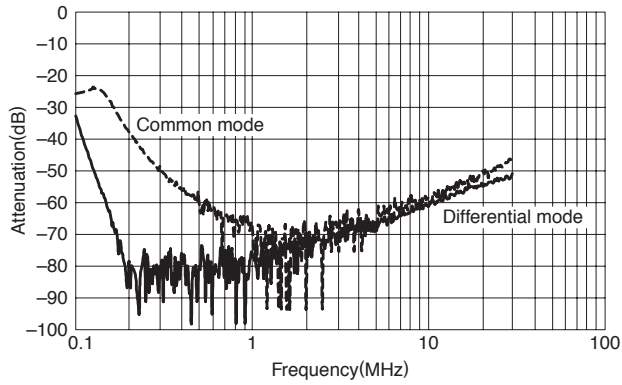

RSMN-2006L

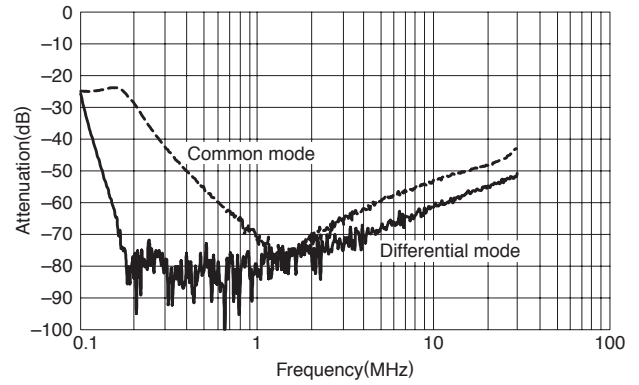

RSMN-2010L

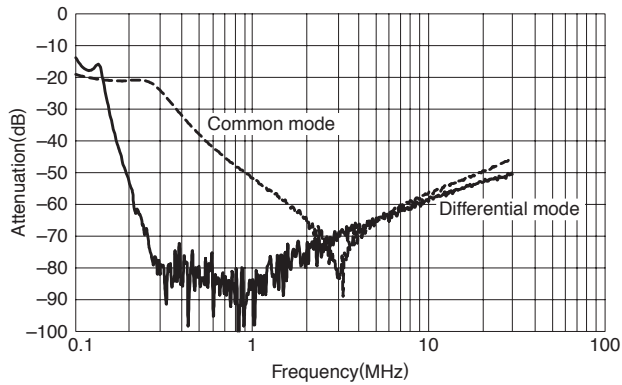

RSMN-2016L

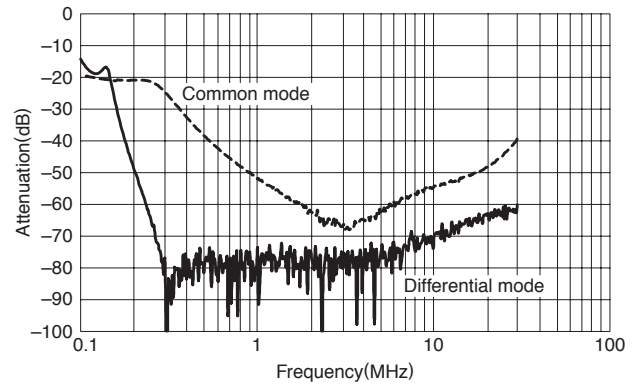

RSMN-2020L

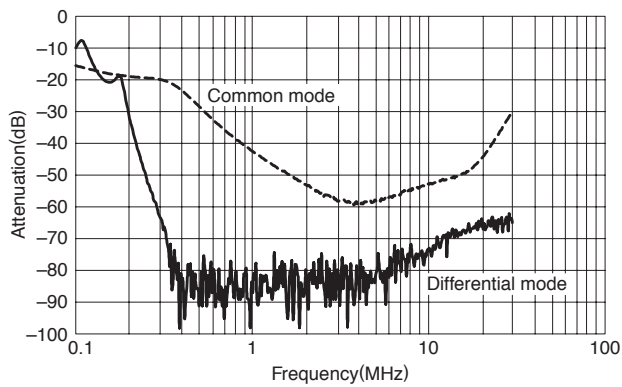

RSMN-2030L

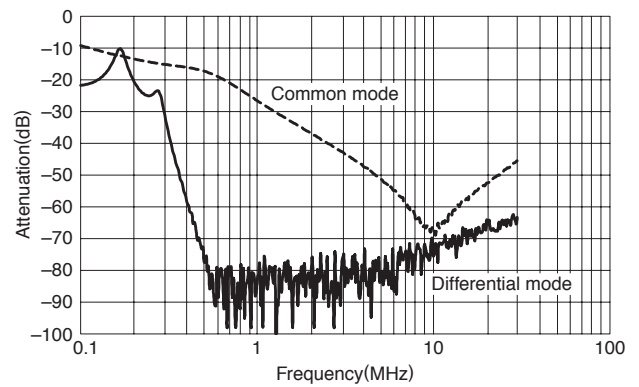

PULSE ATTENUATION CHARACTERISTICS

RSMN-2003/2003D

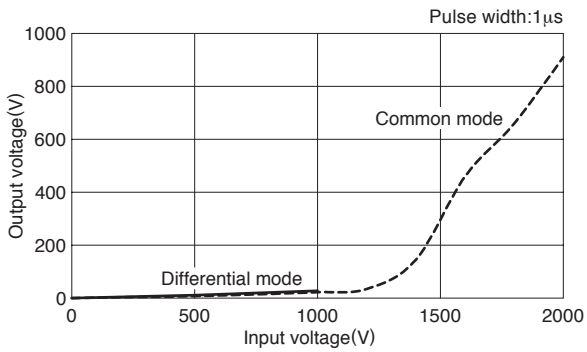

RSMN-2006/2006D

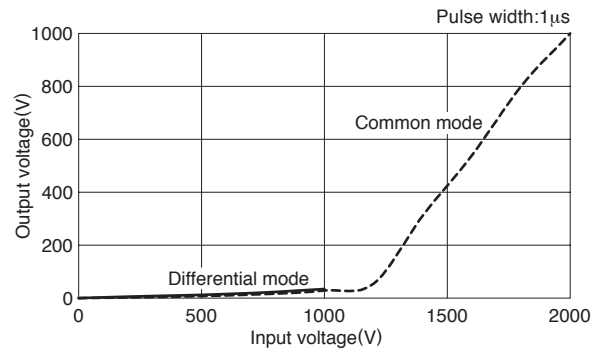

RSMN-2010/2010D

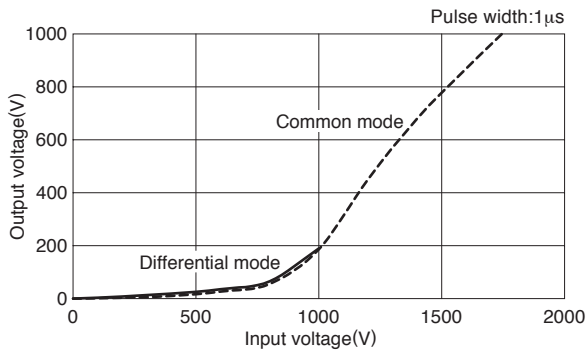

RSMN-2016/2016D

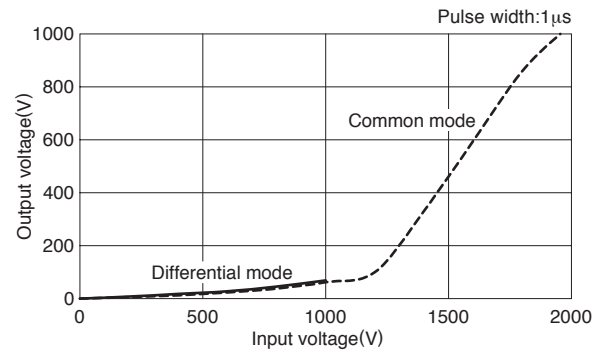

RSMN-2020/2020D

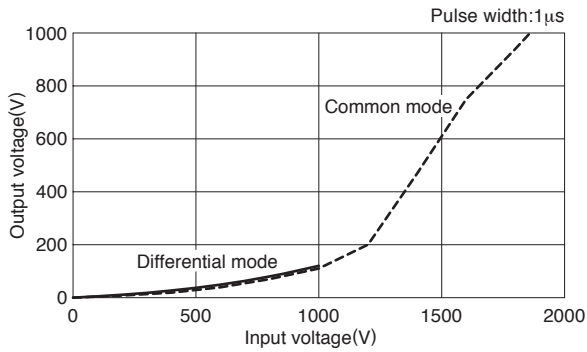

RSMN-2030/2030D

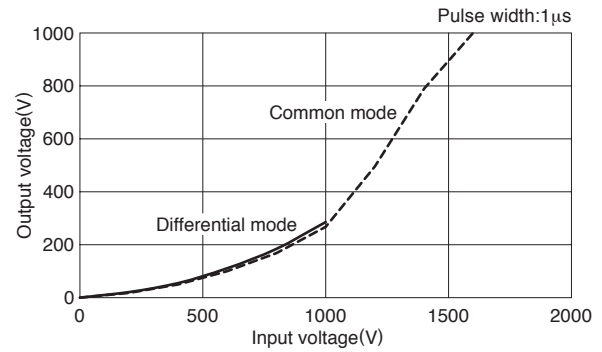

RSMN-2040

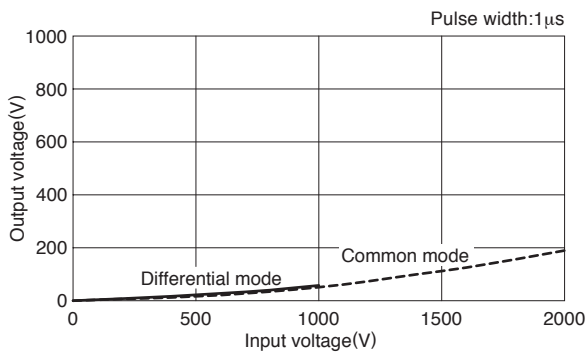

RSMN-2050

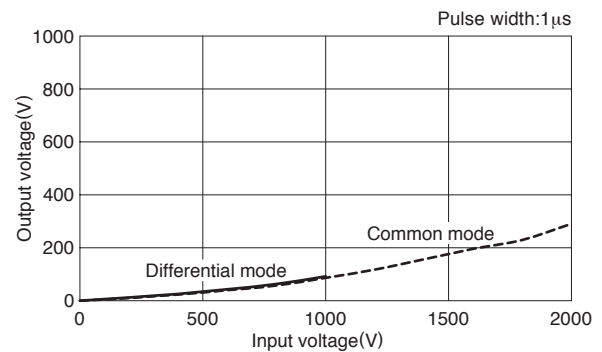

RSMN-2060

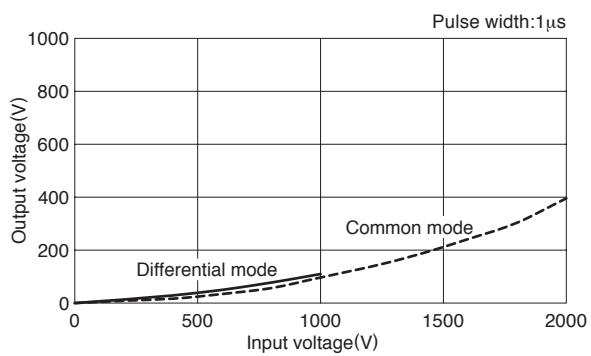

RSMN-2003L/LD

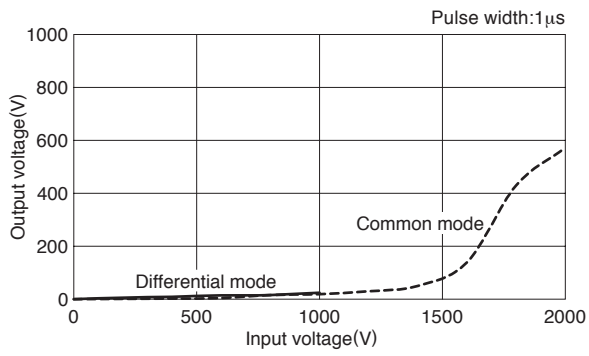

RSMN-2006L/LD

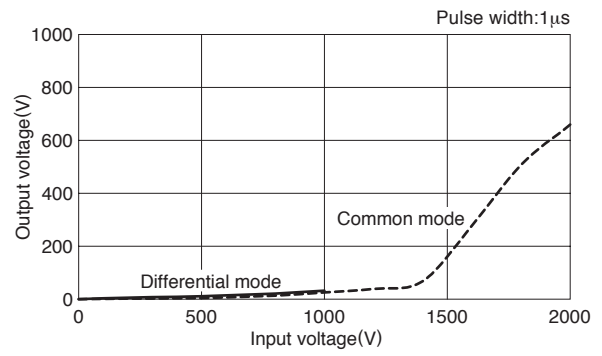

RSMN-2010L/LD

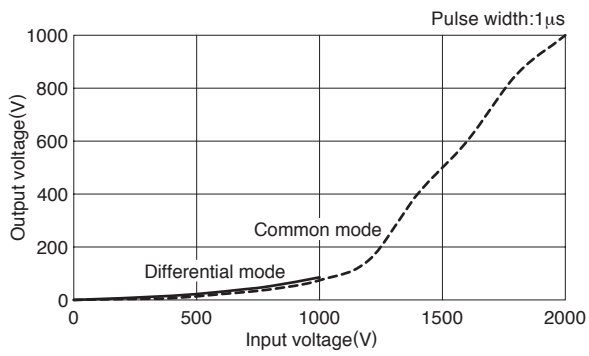

RSMN-2016L/LD

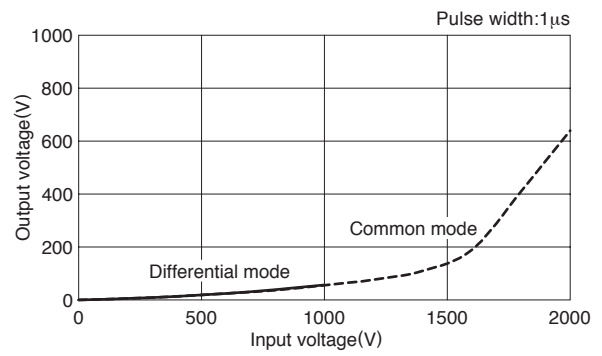

RSMN-2020L/LD

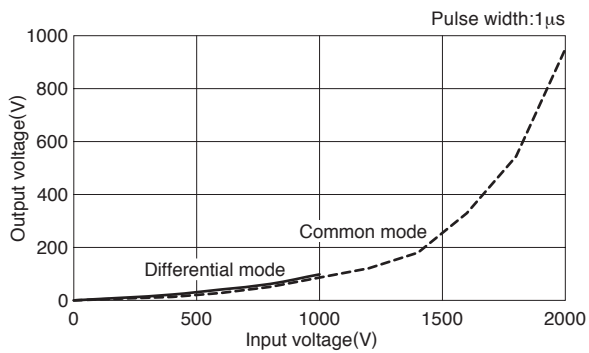

RSMN-2030L/LD

