

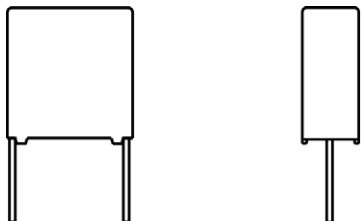

## Interference Suppression Film Capacitors MKP Radial Potted Type



### FEATURES



- AEC-Q200 qualified (rev. C) up to 105 °C
- Compliant with IEC 60381-14: AMD1 grade IIB for pitch  $\geq 15$  mm
  - THB: 85 °C / 85 % RH, 500 h at  $U_{RAC}$
- Compliant with IEC 60381-14: AMD1 grade IA for pitch  $< 15$  mm
  - THB: 40 °C / 93 % RH, 21 days at  $U_{RAC}$
- Material categorization: for definitions of compliance please see [www.vishay.com/doc?99912](http://www.vishay.com/doc?99912)



**RoHS**  
COMPLIANT

### APPLICATIONS

For standard line bypass (between line and ground) Y2 applications  
See also application note: [www.vishay.com/doc?28153](http://www.vishay.com/doc?28153)

| QUICK REFERENCE DATA                             |                                                                                                                                                                                                          |
|--------------------------------------------------|----------------------------------------------------------------------------------------------------------------------------------------------------------------------------------------------------------|
| Capacitance range (E12 series)                   | 0.001 $\mu$ F to 0.1 $\mu$ F (preferred values acc. to E6)                                                                                                                                               |
| Capacitance tolerance                            | $\pm 20$ %                                                                                                                                                                                               |
| Rated voltage                                    | 300 $V_{AC}$ ; 50 Hz to 60 Hz                                                                                                                                                                            |
| Permissible DC voltage                           | 1000 $V_{DC}$ at 105 °C<br>1250 $V_{DC}$ at 85 °C                                                                                                                                                        |
| Climatic testing class (according to EN 60068-1) | 55/105/56/C for product volumes $\leq 1750$ mm <sup>3</sup>                                                                                                                                              |
|                                                  | 55/105/56/B for product volumes $> 1750$ mm <sup>3</sup>                                                                                                                                                 |
| Maximum application temperature                  | 105 °C                                                                                                                                                                                                   |
| Reference standards                              | IEC 60384-14 ed-4 (2013) and EN 60384-14<br>IEC 60065 requires pass. flamm. class B for volumes $> 1750$ mm <sup>3</sup><br>UL 60384-14 2 <sup>nd</sup> edition; CSA E60384-1:14 3 <sup>rd</sup> edition |
| Dielectric                                       | Polypropylene film                                                                                                                                                                                       |
| Electrodes                                       | Metallized film                                                                                                                                                                                          |
| Construction                                     | Series construction<br>                                                                                              |
|                                                  | Triple construction<br>                                                                                              |
| Encapsulation                                    | Plastic case, epoxy resin sealed, flame retardant class UL 94 V-0                                                                                                                                        |
| Terminals                                        | Tinned wire                                                                                                                                                                                              |
| Marking                                          | C-value; tolerance; rated voltage; sub-class; manufacturer's type designation; code for dielectric material, manufacturer location; manufacturer's logo, year and week; safety approvals                 |

### Note

- For more detailed data and test requirements, contact [rfi@vishay.com](mailto:rfi@vishay.com)

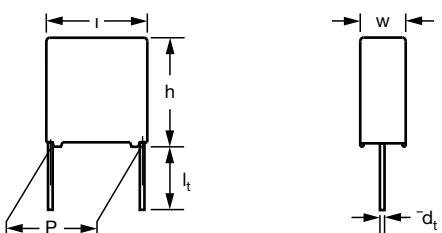
| DIMENSIONS                                                                           |
|--------------------------------------------------------------------------------------|
|  |



**COMPOSITION OF CATALOG NUMBER**

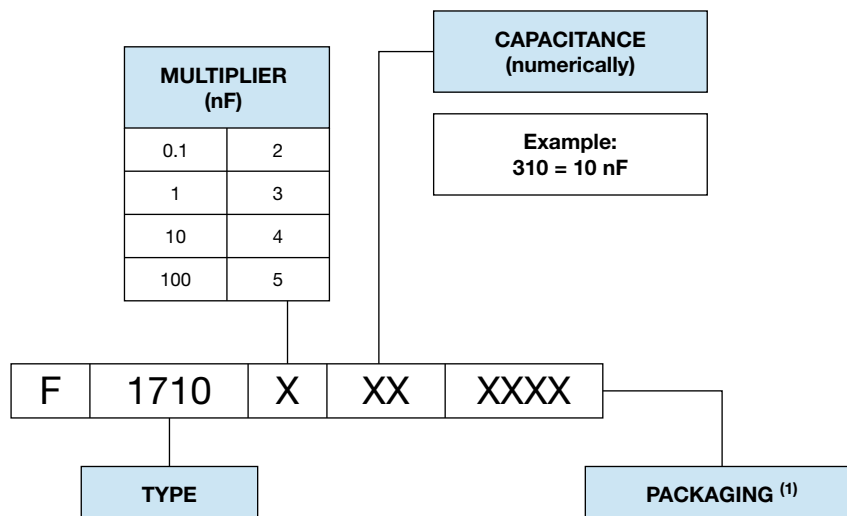

**Note**

(1) For detailed tape specification refer to "Packaging Information" [www.vishay.com/doc?28139](http://www.vishay.com/doc?28139)

| SPECIFIC REFERENCE DATA                                                          |                                                   |                          |
|----------------------------------------------------------------------------------|---------------------------------------------------|--------------------------|
| DESCRIPTION                                                                      | VALUE                                             |                          |
| Rated AC voltage ( $U_{RAC}$ )                                                   | 300 V                                             |                          |
| Permissible DC voltage ( $U_{RDC}$ )                                             | 1000 $V_{DC}$ at 105 °C<br>1250 $V_{DC}$ at 85 °C |                          |
| Tangent of loss angle<br>$C \leq 100$ nF                                         | At 1 kHz                                          | At 10 kHz                |
|                                                                                  | $\leq 10 \times 10^{-4}$                          | $\leq 20 \times 10^{-4}$ |
| Rated voltage pulse slope ( $dU/dt$ ) <sub>R</sub> at 420 $V_{DC}$               | 100 V/ $\mu$ s                                    |                          |
| R between leads at 100 V; 1 min                                                  | > 15 000 M $\Omega$                               |                          |
| R between leads and case; 100 V; 1 min                                           | > 30 000 M $\Omega$                               |                          |
| Withstanding (DC) voltage (cut off current 10 mA) (1); rise time $\leq 1000$ V/s | 3400 V; 1 min                                     |                          |
| Withstanding (AC) voltage between leads and case                                 | 2100 V; 1 min                                     |                          |
| Maximum application temperature                                                  | 105 °C                                            |                          |

**Note**

(1) See "Voltage Proof Test for Metalized Film Capacitors": [www.vishay.com/doc?28169](http://www.vishay.com/doc?28169)



| ELECTRICAL DATA AND ORDERING INFORMATION                                            |                   |                                 |                            |                                       |                                     |         |                                         |         |                                                                                   |         |     |         |      |
|-------------------------------------------------------------------------------------|-------------------|---------------------------------|----------------------------|---------------------------------------|-------------------------------------|---------|-----------------------------------------|---------|-----------------------------------------------------------------------------------|---------|-----|---------|------|
| U <sub>RDC</sub><br>(V)                                                             | CAP.<br>(µF)      | DIMENSIONS<br>w x h x l<br>(mm) | MASS<br>(g) <sup>(3)</sup> | CATALOG NUMBER F1710... AND PACKAGING |                                     |         |                                         |         |                                                                                   |         |     |         |      |
|                                                                                     |                   |                                 |                            | LOOSE IN BOX                          |                                     |         |                                         |         | TAPED                                                                             |         |     |         |      |
|                                                                                     |                   |                                 |                            | SHORT LEADS                           |                                     |         | LONG LEADS                              |         | REEL:<br>Ø = 500 mm <sup>(1)(2)</sup><br>H = 18.5 mm;<br>P <sub>0</sub> = 12.7 mm |         |     |         |      |
|                                                                                     |                   |                                 |                            | l <sub>t</sub> = 4 mm<br>- 1 mm       | l <sub>t</sub> = 6.0 mm<br>- 1.0 mm | SPQ     | l <sub>t</sub> =<br>30.0 mm<br>+ 5.0 mm | SPQ     | SPQ                                                                               |         |     |         |      |
| <b>PITCH = 15 mm ± 0.4 mm; d<sub>t</sub> = 0.60 mm ± 0.06 mm; C-TOL. = ± 20 %</b>   |                   |                                 |                            |                                       |                                     |         |                                         |         |                                                                                   |         |     |         |      |
| 1000                                                                                | 0.0010            | 5.0 x 11.0 x 17.5               | 1                          | 2101004                               | 2101000                             | 750     | 2101030                                 | 900     | 2101901                                                                           | 1000    |     |         |      |
|                                                                                     | 0.0012            |                                 |                            | 2121004                               | 2121000                             |         | 2121030                                 |         | 2121901                                                                           |         |     |         |      |
|                                                                                     | 0.0015            |                                 |                            | 2151004                               | 2151000                             |         | 2151030                                 |         | 2151901                                                                           |         |     |         |      |
|                                                                                     | 0.0018            |                                 |                            | 2181004                               | 2181000                             |         | 2181030                                 |         | 2181901                                                                           |         |     |         |      |
|                                                                                     | 0.0022            |                                 |                            | 2221004                               | 2221000                             |         | 2221030                                 |         | 2221901                                                                           |         |     |         |      |
|                                                                                     | 0.0027            |                                 |                            | 2271004                               | 2271000                             |         | 2271030                                 |         | 2271901                                                                           |         |     |         |      |
|                                                                                     | 0.0033            |                                 |                            | 2331004                               | 2331000                             |         | 2331030                                 |         | 2331901                                                                           |         |     |         |      |
|                                                                                     | 0.0039            |                                 |                            | 2391004                               | 2391000                             |         | 2391030                                 |         | 2391901                                                                           |         |     |         |      |
|                                                                                     | 0.0047            |                                 |                            | 2471004                               | 2471000                             |         | 2471030                                 |         | 2471901                                                                           |         |     |         |      |
|                                                                                     | 0.0056            |                                 |                            | 2561004                               | 2561000                             |         | 2561030                                 |         | 2561901                                                                           |         |     |         |      |
|                                                                                     | 0.0068            |                                 |                            | 2681004                               | 2681000                             |         | 2681030                                 |         | 2681901                                                                           |         |     |         |      |
|                                                                                     | 0.0082            |                                 |                            | 2821004                               | 2821000                             |         | 500                                     |         | 2821030                                                                           |         | 750 | 2821901 | 1000 |
|                                                                                     | 0.010             |                                 |                            | 3101004                               | 3101000                             |         | 450                                     |         | 3101030                                                                           |         | 500 | 3101901 | 800  |
|                                                                                     | 0.012             |                                 |                            | 3121004                               | 3121000                             |         |                                         |         | 3121030                                                                           |         |     | 3121901 |      |
| 0.015                                                                               | 6.0 x 12.0 x 17.5 | 1.4                             | 3151004                    | 3151000                               | 300                                 | 3151030 | 500                                     | 3151901 | 700                                                                               |         |     |         |      |
| 0.018                                                                               |                   |                                 | 3181004                    | 3181000                               |                                     | 3181030 |                                         | 3181901 |                                                                                   |         |     |         |      |
| <b>PITCH = 15 mm ± 0.4 mm; d<sub>t</sub> = 0.80 mm ± 0.08 mm; C-TOL. = ± 20 %</b>   |                   |                                 |                            |                                       |                                     |         |                                         |         |                                                                                   |         |     |         |      |
| 0.022                                                                               | 7.0 x 13.5 x 17.5 | 1.8                             | 3221004                    | 3221000                               | 300                                 | 3221030 | 500                                     | 3221901 | 700                                                                               |         |     |         |      |
| <b>PITCH = 22.5 mm ± 0.4 mm; d<sub>t</sub> = 0.80 mm ± 0.08 mm; C-TOL. = ± 20 %</b> |                   |                                 |                            |                                       |                                     |         |                                         |         |                                                                                   |         |     |         |      |
| 0.027                                                                               | 6.0 x 15.5 x 26.0 | 2.4                             | 3271004                    | 3271000                               | 260                                 | 3271030 | 750                                     | 3271901 | 600                                                                               |         |     |         |      |
| 0.033                                                                               |                   |                                 | 3331004                    | 3331000                               |                                     | 3331030 |                                         | 3331901 |                                                                                   |         |     |         |      |
| 0.039                                                                               | 7.0 x 16.5 x 26.0 | 2.9                             | 3391004                    | 3391000                               | 235                                 | 3391030 | 750                                     | 3391901 | 500                                                                               |         |     |         |      |
| 0.047                                                                               |                   |                                 | 3471004                    | 3471000                               | 200                                 | 3471030 | 750                                     | 3471901 | 450                                                                               |         |     |         |      |
| 0.056                                                                               |                   |                                 | 8.5 x 18.0 x 26.0          | 3.8                                   | 3561004                             | 3561000 | 170                                     | 3561030 | 500                                                                               | 3561901 | 400 |         |      |
| 0.068                                                                               | 3681004           | 3681000                         |                            |                                       | 3681030                             | 3681901 |                                         |         |                                                                                   |         |     |         |      |
| <b>PITCH = 27.5 mm ± 0.4 mm; d<sub>t</sub> = 0.80 mm ± 0.08 mm; C-TOL. = ± 20 %</b> |                   |                                 |                            |                                       |                                     |         |                                         |         |                                                                                   |         |     |         |      |
| 0.082                                                                               | 9.0 x 19.0 x 31.0 | 5.5                             | 3821004                    | 3821000                               | 125                                 | 3821030 | 400                                     | 3821901 | 250                                                                               |         |     |         |      |
| 0.100                                                                               |                   |                                 | 4101004                    | 4101000                               |                                     | 4101030 |                                         | 4101901 |                                                                                   |         |     |         |      |

**Notes**

- SPQ = Standard Packing Quantity
- (1) Reel diameter = 365 mm is available on request
- (2) H = In-tape height; P<sub>0</sub> = Sprocket hole distance; for detailed specifications refer to "Packaging Information"
- (3) Weight for short lead product only



| APPROVALS                                                                                                                                                                                                                                                                                                                                                           |                     |                    |                       |                                                                        |
|---------------------------------------------------------------------------------------------------------------------------------------------------------------------------------------------------------------------------------------------------------------------------------------------------------------------------------------------------------------------|---------------------|--------------------|-----------------------|------------------------------------------------------------------------|
| SAFETY APPROVALS Y2                                                                                                                                                                                                                                                                                                                                                 | VOLTAGE             | VALUE              | FILE NUMBERS          | LINKS                                                                  |
| EN 60384-14 (ENEC)<br>(= IEC 60384-14 ed-4 (2013))                                                                                                                                                                                                                                                                                                                  | 300 V <sub>AC</sub> | 0.001 µF to 0.1 µF | ENEC16/FI/21/01048/A1 | <a href="http://www.vishay.com/doc?28212">www.vishay.com/doc?28212</a> |
| UL 60384-14 2 <sup>nd</sup> edition                                                                                                                                                                                                                                                                                                                                 | 300 V <sub>AC</sub> | 0.001 µF to 0.1 µF | E354331               | <a href="http://www.vishay.com/doc?28189">www.vishay.com/doc?28189</a> |
| CSA E60384-1:14 3 <sup>rd</sup> edition                                                                                                                                                                                                                                                                                                                             | 300 V <sub>AC</sub> | 0.001 µF to 0.1 µF | E354331               |                                                                        |
| CB-test certificate                                                                                                                                                                                                                                                                                                                                                 | 300 V <sub>AC</sub> | 0.001 µF to 0.1 µF | FI-39810/A1           | <a href="http://www.vishay.com/doc?28213">www.vishay.com/doc?28213</a> |
| The ENEC-approval together with the CB-certificate replace all national marks of the following countries (they have already signed the ENEC-agreement): Austria; Belgium; Czech. Republic; Denmark; Finland; France; Germany; Greece; Hungary; Ireland; Italy; Luxembourg; Netherlands; Norway; Portugal; Slovenian; Spain; Sweden, Switzerland and United Kingdom. |                     |                    |                       |                                                                        |
|                                                                                                                                                                                                                                                                                                                                                                     |                     |                    |                       |                                                                        |

**MOUNTING**

**Normal Use**

The capacitors are designed for mounting on printed-circuit boards. The capacitors packed in bandoleers are designed for mounting in printed circuit boards by means of automatic insertion machines.

For detailed tape specifications refer to packaging information: [www.vishay.com/doc?28139](http://www.vishay.com/doc?28139)

**Specific Method of Mounting to Withstand Vibration and Shock**

In order to withstand vibration and shock tests, it must be ensured that the stand-off pips are in good contact with the printed-circuit board:

- For pitches ≤ 15 mm capacitors shall be mechanically fixed by the leads
- For larger pitches the capacitors shall be mounted in the same way and the body clamped

**Space Requirements on Printed-Circuit Board**

The maximum space for length ( $l_{max.}$ ), width ( $w_{max.}$ ), and height ( $h_{max.}$ ) of film capacitors to take in account on the printed-circuit board is shown in the drawings:

- For products with pitch ≤ 15 mm,  $\Delta w = \Delta l = 0.3$  mm;  $\Delta h = 0.1$  mm
- For products with 15 mm < pitch, ≤ 27.5 mm,  $\Delta w = \Delta l = 0.5$  mm;  $\Delta h = 0.1$  mm

Eccentricity defined as in drawing. The maximum eccentricity is smaller than or equal to the lead diameter of the product concerned.

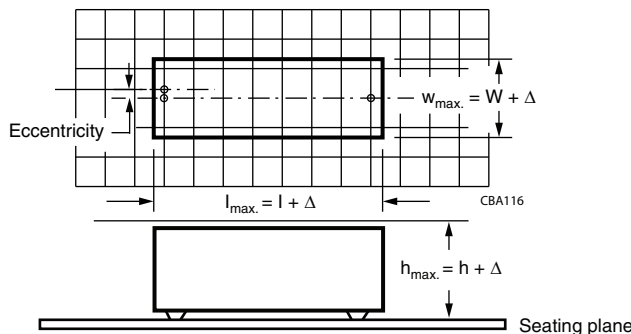

**SOLDERING CONDITIONS**

For general soldering conditions and wave soldering profile, we refer to the application note: "Soldering Guidelines for Film Capacitors": [www.vishay.com/doc?28171](http://www.vishay.com/doc?28171)

**Storage Temperature**

$T_{stg} = -25$  °C to  $+35$  °C with RH maximum 75 % without condensation

**Ratings and Characteristics Reference Conditions**

Unless otherwise specified, all electrical values apply to an ambient temperature of  $23$  °C ± 1 °C, an atmospheric pressure of 86 kPa to 106 kPa and a relative humidity of 50 % ± 2 %.

For reference testing, a conditioning period shall be applied over  $96$  h ± 4 h by heating the products in a circulating air oven at the rated temperature and a relative humidity not exceeding 20 %.



**CHARACTERISTICS**

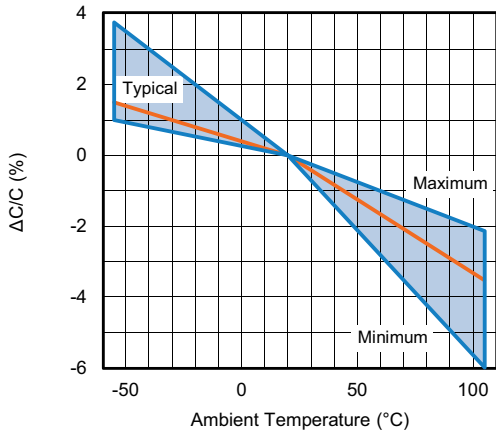

Capacitance as a function of ambient temperature (typical curve)

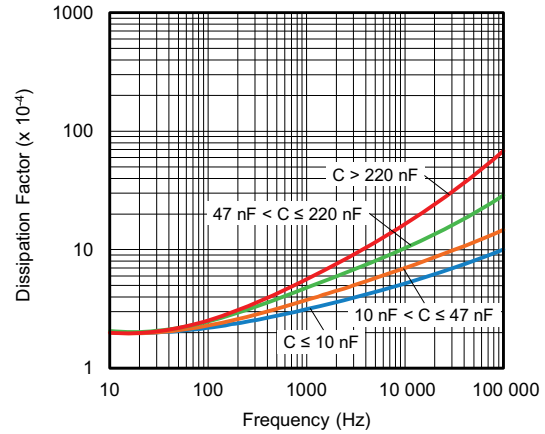

Tangent of loss angle as a function of frequency (typical curve)

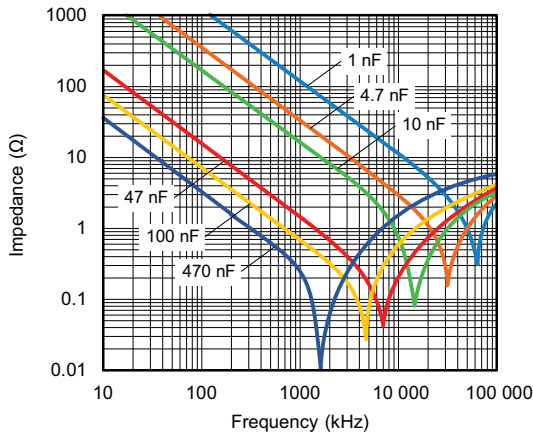

Impedance as a function of frequency (typical curve)

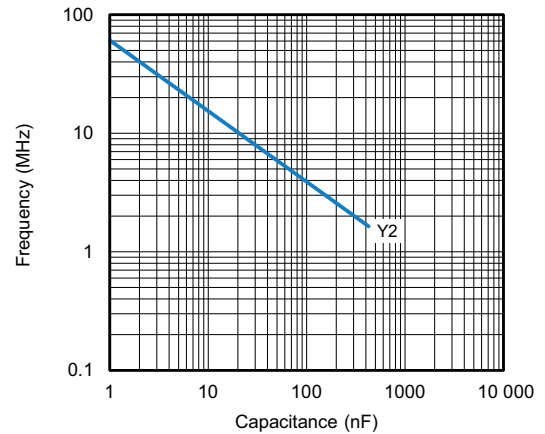

Resonant frequency as a function of capacitance (typical curve)

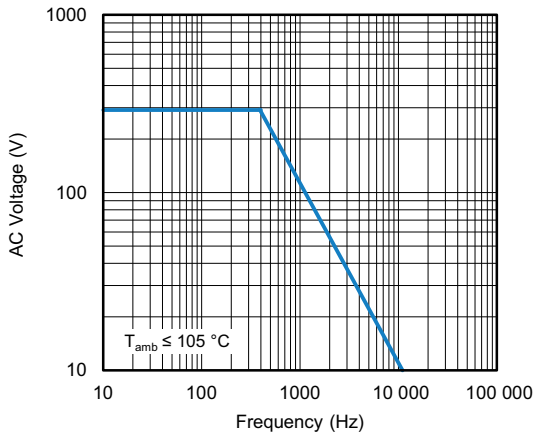

Max. RMS voltage as a function of frequency

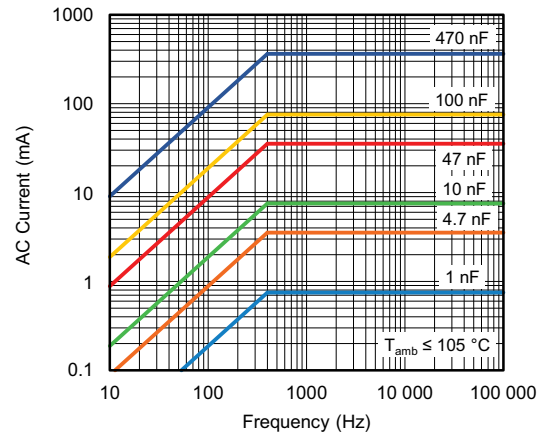

Max. RMS current as a function of frequency

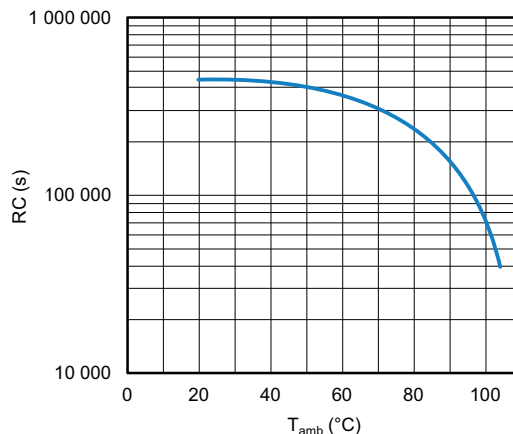

Insulation resistance as a function of ambient temperature

**APPLICATION NOTES**

- For X2 electromagnetic interference suppression in **standard across the line application** (50 Hz / 60 Hz) with a maximum mains voltage of 310 V<sub>AC</sub>
- For series impedance applications we refer to the “Application Note”: [www.vishay.com/doc?28153](http://www.vishay.com/doc?28153)
- For capacitors connected in parallel, normally the proof voltage and possibly the rated voltage must be reduced. For information depending of the capacitance value and the number of parallel connections contact: [rfi@vishay.com](mailto:rfi@vishay.com)
- These capacitors are not intended for continuous pulse applications. For these situations, capacitors of the AC and pulse program must be used
- The maximum ambient temperature must not exceed 110 °C (125 °C for less than 1000 h) for C ≤ 470 nF and 110 °C for C > 470 nF
- Rated voltage pulse slope:  
If the pulse voltage is lower than the rated voltage, the values of the specific reference data can be multiplied by 435 V<sub>DC</sub> and divided by the applied voltage

**INSPECTION REQUIREMENTS**

**General Notes**

Sub-clause numbers of tests and performance requirements refer to the “Sectional Specification, publication IEC 60384-14 ed-4 (2013) and Specific Reference Data”.

| <b>GROUP C INSPECTION REQUIREMENTS</b>                |                                                                             |                                                               |
|-------------------------------------------------------|-----------------------------------------------------------------------------|---------------------------------------------------------------|
| <b>SUB-CLAUSE NUMBER AND TEST</b>                     | <b>CONDITIONS</b>                                                           | <b>PERFORMANCE REQUIREMENTS</b>                               |
| <b>SUB-GROUP C-1A PART OF SAMPLE OF SUB-GROUP C-1</b> |                                                                             |                                                               |
| 4.1 Dimensions (detail)<br><br>Initial measurements   | Capacitance<br>Tangent of loss angle:<br>at 10 kHz                          | As specified in chapters “General Data” of this specification |
| 4.3 Robustness of terminations                        | Tensile: Load 10 N; 10 s<br>Bending: Load 5 N; 4 x 90°                      | No visible damage                                             |
| 4.4 Resistance to soldering heat                      | No pre-drying<br>Method: 1A<br>Solder bath: 280 °C ± 5 °C<br>Duration: 10 s |                                                               |



| GROUP C INSPECTION REQUIREMENTS                     |                                                                                                                                                                                                                                                   |                                                                                                                                                                                                                                                                       |
|-----------------------------------------------------|---------------------------------------------------------------------------------------------------------------------------------------------------------------------------------------------------------------------------------------------------|-----------------------------------------------------------------------------------------------------------------------------------------------------------------------------------------------------------------------------------------------------------------------|
| SUB-CLAUSE NUMBER AND TEST                          | CONDITIONS                                                                                                                                                                                                                                        | PERFORMANCE REQUIREMENTS                                                                                                                                                                                                                                              |
| <b>SUB-GROUP C1A PART OF SAMPLE OF SUB-GROUP C1</b> |                                                                                                                                                                                                                                                   |                                                                                                                                                                                                                                                                       |
| 4.19 Component solvent resistance                   | Isopropylalcohol at room temperature<br>Method: 2<br>Immersion time: 5 min ± 0.5 min<br>Recovery time: Min. 1 h, max. 2 h                                                                                                                         |                                                                                                                                                                                                                                                                       |
| 4.4.2 Final measurements                            | Visual examination<br><br>Capacitance<br><br>Tangent of loss angle<br><br>Insulation resistance                                                                                                                                                   | No visible damage<br>Legible marking<br><br>$ \Delta C/C  \leq 5\%$ of the value measured initially<br><br>Increase of $\tan \delta \leq 0.008$<br>Compared to values measured initially<br><br>As specified in section "Insulation Resistance" of this specification |
| <b>SUB-GROUP C1B PART OF SAMPLE OF SUB-GROUP C1</b> |                                                                                                                                                                                                                                                   |                                                                                                                                                                                                                                                                       |
| Initial measurements                                | Capacitance<br>Tangent of loss angle:<br>at 10 kHz                                                                                                                                                                                                |                                                                                                                                                                                                                                                                       |
| 4.20 Solvent resistance of the marking:             | Isopropylalcohol at room temperature<br>Method: 1<br>Rubbing material: Cotton wool<br>Immersion time: 5 min ± 0.5 min                                                                                                                             | No visible damage<br>Legible marking                                                                                                                                                                                                                                  |
| 4.6 Rapid change of temperature                     | $\theta A = -55\text{ }^\circ\text{C}$<br>$\theta B = +105\text{ }^\circ\text{C}$<br>5 cycles<br>Duration $t = 30\text{ min}$                                                                                                                     |                                                                                                                                                                                                                                                                       |
| 4.6.1 Inspection<br>4.7 Vibration                   | Visual examination<br>Mounting: See section "Mounting" of this specification<br>Procedure B4:<br>Frequency range: 10 Hz to 55 Hz<br>Amplitude: 0.75 mm or<br>Acceleration 98 m/s <sup>2</sup><br>(whichever is less severe)<br>Total duration 6 h | No visible damage                                                                                                                                                                                                                                                     |
| 4.7.2 Final inspection                              | Visual examination                                                                                                                                                                                                                                | No visible damage                                                                                                                                                                                                                                                     |
| 4.9 Shock                                           | Mounting: See section "Mounting" for more information<br>Pulse shape: Half sine<br>Acceleration: 490 m/s <sup>2</sup><br>Duration of pulse: 11 ms                                                                                                 |                                                                                                                                                                                                                                                                       |
| 4.9.2 Final measurements                            | Visual examination<br><br>Capacitance<br><br>Tangent of loss angle<br><br>Insulation resistance                                                                                                                                                   | No visible damage<br><br>$ \Delta C/C  \leq 5\%$ of the value measured initially<br><br>Increase of $\tan \delta \leq 0.008$<br>Compared to values measured initially<br><br>As specified in section "Insulation Resistance" of this specification                    |



| GROUP C INSPECTION REQUIREMENTS                                            |                                                                                                                                                                       |                                                                                                                                                                                                                                                                                                                                        |
|----------------------------------------------------------------------------|-----------------------------------------------------------------------------------------------------------------------------------------------------------------------|----------------------------------------------------------------------------------------------------------------------------------------------------------------------------------------------------------------------------------------------------------------------------------------------------------------------------------------|
| SUB-CLAUSE NUMBER AND TEST                                                 | CONDITIONS                                                                                                                                                            | PERFORMANCE REQUIREMENTS                                                                                                                                                                                                                                                                                                               |
| <b>SUB-GROUP C1 COMBINED SAMPLE OF SPECIMENS OF SUB-GROUPS C1A AND C1B</b> |                                                                                                                                                                       |                                                                                                                                                                                                                                                                                                                                        |
| 4.11 Climatic sequence                                                     |                                                                                                                                                                       |                                                                                                                                                                                                                                                                                                                                        |
| 4.11.1 Initial measurements                                                | Capacitance<br>Measured in 4.4.2 and 4.9.2<br>Tangent of loss angle:<br>Measured initially in C1A and C1B                                                             |                                                                                                                                                                                                                                                                                                                                        |
| 4.11.2 Dry heat                                                            | Temperature: 105 °C<br>Duration: 16 h                                                                                                                                 |                                                                                                                                                                                                                                                                                                                                        |
| 4.11.3 Damp heat cyclic<br>Test Db<br>First cycle                          |                                                                                                                                                                       |                                                                                                                                                                                                                                                                                                                                        |
| 4.11.4 Cold                                                                | Temperature: - 55 °C<br>Duration: 2 h                                                                                                                                 |                                                                                                                                                                                                                                                                                                                                        |
| 4.11.5 Damp heat cyclic<br>Test Db<br>remaining cycles                     |                                                                                                                                                                       |                                                                                                                                                                                                                                                                                                                                        |
| 4.11.6 Final measurements                                                  | Visual examination<br><br>Capacitance<br><br>Tangent of loss angle<br><br>Voltage proof<br>2250 V <sub>DC</sub> ; 1 min between terminations<br>Insulation resistance | No visible damage<br>Legible marking<br><br>$ \Delta C/C  \leq 5\%$ of the value measured in 4.11.1.<br><br>Increase of $\tan \delta \leq 0.008$<br>Compared to values measured in 4.11.1<br><br>No permanent breakdown or flash-over<br><br>$\geq 50\%$ of values specified in section "Insulation Resistance" of this specification  |
| <b>SUB-GROUP C2</b>                                                        |                                                                                                                                                                       |                                                                                                                                                                                                                                                                                                                                        |
| 4.12 Damp heat steady state                                                | 56 days, 40 °C, 90 % to 95 % RH,<br>no load capacitance                                                                                                               |                                                                                                                                                                                                                                                                                                                                        |
| 4.12.1 Initial measurements                                                | Tangent of loss angle at 1 kHz                                                                                                                                        |                                                                                                                                                                                                                                                                                                                                        |
| 4.12.3 Final measurements                                                  | Visual examination<br><br>Capacitance<br><br>Tangent of loss angle<br><br>Voltage proof<br>2250 V <sub>DC</sub> ; 1 min between terminations<br>Insulation resistance | No visible damage<br>Legible marking<br><br>$ \Delta C/C  \leq 5\%$ of the value measured in 4.12.1.<br><br>Increase of $\tan \delta \leq 0.007$<br>Compared to values measured in 4.12.1.<br><br>No permanent breakdown or flash-over<br><br>$\geq 50\%$ of values specified in section "Insulation Resistance" of this specification |





| <b>GROUP C INSPECTION REQUIREMENTS</b> |                                                                                                                                                                                                                                         |                                                                                                                                                                                                                                                                                                                    |
|----------------------------------------|-----------------------------------------------------------------------------------------------------------------------------------------------------------------------------------------------------------------------------------------|--------------------------------------------------------------------------------------------------------------------------------------------------------------------------------------------------------------------------------------------------------------------------------------------------------------------|
| <b>SUB-CLAUSE NUMBER AND TEST</b>      | <b>CONDITIONS</b>                                                                                                                                                                                                                       | <b>PERFORMANCE REQUIREMENTS</b>                                                                                                                                                                                                                                                                                    |
| <b>SUB-GROUP C3</b>                    |                                                                                                                                                                                                                                         |                                                                                                                                                                                                                                                                                                                    |
| 4.13.1 Initial measurements            | Capacitance<br>Tangent of loss angle:<br>at 10 kHz                                                                                                                                                                                      |                                                                                                                                                                                                                                                                                                                    |
| 4.13 Impulse voltage                   | 3 successive impulses, full wave, peak voltage:<br>X1: 5 kV<br>Max. 24 pulses                                                                                                                                                           | No selfhealing breakdowns or flash-over                                                                                                                                                                                                                                                                            |
| 4.14 Endurance                         | Duration: 1000 h<br>1.7 x U <sub>RAC</sub> at 105 °C<br>Once in every hour the voltage is increased to 1000 V <sub>RMS</sub> for 0.1 s via resistor of 47 Ω ± 5 %                                                                       |                                                                                                                                                                                                                                                                                                                    |
| 4.14.7 Final measurements              | Visual examination<br><br>Capacitance<br><br>Tangent of loss angle<br><br>Voltage proof<br>2250 V <sub>DC</sub> ; 1 min between terminations<br>2100 V <sub>AC</sub> ; 1 min between terminations and case<br><br>Insulation resistance | No visible damage<br>Legible marking<br><br> ΔC/C  ≤ 10 % compared to values measured in 4.13.1.<br><br>Increase of tan δ ≤ 0.008<br>Compared to values measured in 4.13.1.<br><br>No permanent breakdown or flash-over<br><br>≥ 50 % of values specified in section "Insulation Resistance" of this specification |
| <b>SUB-GROUP C4</b>                    |                                                                                                                                                                                                                                         |                                                                                                                                                                                                                                                                                                                    |
| 4.15 Charge and discharge              | 10 000 cycles<br>charged to 420 V <sub>DC</sub><br>Discharge resistance:<br>$R = \frac{420 V_{DC}}{1.5 \times C (dU/dt)}$                                                                                                               |                                                                                                                                                                                                                                                                                                                    |
| 4.15.1 Initial measurements            | Capacitance<br>Tangent of loss angle:<br>at 10 kHz                                                                                                                                                                                      |                                                                                                                                                                                                                                                                                                                    |
| 4.15.3 Final measurements              | Capacitance<br><br>Tangent of loss angle<br><br>Insulation resistance                                                                                                                                                                   | ΔC/C  ≤ 10 % compared to values measured in 4.15.1.<br><br>Increase of tan δ ≤ 0.008<br>Compared to values measured in 4.15.1.<br><br>≥ 50 % of values specified in section "Insulation Resistance" of this specification                                                                                          |
| <b>SUB-GROUP C5</b>                    |                                                                                                                                                                                                                                         |                                                                                                                                                                                                                                                                                                                    |
| 4.16 Radio frequency characteristic    | Resonance frequency                                                                                                                                                                                                                     | ≥ 0.9 times the value as specified in section "Resonant Frequency" of this specification                                                                                                                                                                                                                           |

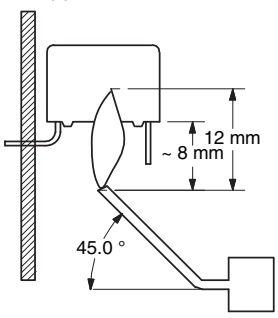

| GROUP C INSPECTION REQUIREMENTS                           |                                                                                                                                                                                                                                                                                                                               |                                                                                                                                                                                                                                                                                                                                 |
|-----------------------------------------------------------|-------------------------------------------------------------------------------------------------------------------------------------------------------------------------------------------------------------------------------------------------------------------------------------------------------------------------------|---------------------------------------------------------------------------------------------------------------------------------------------------------------------------------------------------------------------------------------------------------------------------------------------------------------------------------|
| SUB-CLAUSE NUMBER AND TEST                                | CONDITIONS                                                                                                                                                                                                                                                                                                                    | PERFORMANCE REQUIREMENTS                                                                                                                                                                                                                                                                                                        |
| <b>SUB-GROUP C6</b>                                       |                                                                                                                                                                                                                                                                                                                               |                                                                                                                                                                                                                                                                                                                                 |
| 4.17 Passive flammability<br>Class B/C                    | Bore of gas jet: $\varnothing$ 0.5 mm<br>Fuel: Butane<br>Test duration for actual volume V in mm <sup>3</sup> :<br>V $\leq$ 250: 5 s<br>250 < V $\leq$ 500: 10 s<br>500 < V $\leq$ 1750: 20 s<br>V > 1750: 60 s<br>One flame application<br> | After removing test flame from capacitor, the capacitor must not continue to burn for more than 30 s for V $\leq$ 1750 mm <sup>3</sup> and 10 s for V > 1750 mm <sup>3</sup> . No burning particle must drop from the sample.                                                                                                   |
| <b>SUB-GROUP C7</b>                                       |                                                                                                                                                                                                                                                                                                                               |                                                                                                                                                                                                                                                                                                                                 |
| 4.18 Active flammability                                  | 20 cycles of 5 kV discharges on the test capacitor connected to U <sub>RAC</sub>                                                                                                                                                                                                                                              | The cheese cloth around the capacitors shall not burn with a flame.<br>No electrical measurements are required.                                                                                                                                                                                                                 |
| <b>SUB-GROUP ADD6 (FOR PITCH <math>\geq</math> 15 mm)</b> |                                                                                                                                                                                                                                                                                                                               |                                                                                                                                                                                                                                                                                                                                 |
| A.6 Damp heat steady state with load                      | RH: 85 %, temp.: 85 °C<br>Load: 300 V <sub>AC</sub> , duration: 500 h                                                                                                                                                                                                                                                         |                                                                                                                                                                                                                                                                                                                                 |
| A.6.1 Initial measurements                                | Capacitance<br>Tangent of loss angle: at 10 kHz                                                                                                                                                                                                                                                                               |                                                                                                                                                                                                                                                                                                                                 |
| A.6.2 Final measurements                                  | Visual examination<br>Capacitance<br>Tangent of loss angle<br>Insulation resistance                                                                                                                                                                                                                                           | No visible damage<br>Legible marking<br><br>$ \Delta C/C  \leq 10$ % of the value measured in A.6.1<br><br>Increase of $\tan \delta \leq 0.024$<br>Compared to values measured in A.6.1<br>No permanent breakdown or flash-over<br><br>$\geq 50$ % of values specified in section "Insulation Resistance" of this specification |
| <b>SUB-GROUP ADD7</b>                                     |                                                                                                                                                                                                                                                                                                                               |                                                                                                                                                                                                                                                                                                                                 |
| A.7 Damp heat steady state with voltage                   | RH: 40 %, temp.: 93 °C<br>Voltage: 300 V <sub>AC</sub> , duration: 21 days                                                                                                                                                                                                                                                    |                                                                                                                                                                                                                                                                                                                                 |
| A.7.1 Initial measurements                                | Capacitance<br>Tangent of loss angle: at 10 kHz                                                                                                                                                                                                                                                                               |                                                                                                                                                                                                                                                                                                                                 |
| A.7.2 Final measurements                                  | Visual examination<br>Capacitance<br>Tangent of loss angle<br>Insulation resistance                                                                                                                                                                                                                                           | No visible damage<br>Legible marking<br><br>$ \Delta C/C  \leq 10$ % of the value with initial measurement<br>Increase of $\tan \delta \leq 0.024$<br>Compared to values with initial measurement<br><br>$\geq 50$ % of values specified in section "Insulation Resistance" of this specification                               |



| TEST CONDITIONS AND REQUIREMENTS ACCORDING AEC-Q200 REVISION C |                                      |                        |                                                                      |                                                                                                                                                  |
|----------------------------------------------------------------|--------------------------------------|------------------------|----------------------------------------------------------------------|--------------------------------------------------------------------------------------------------------------------------------------------------|
| NO.                                                            | TEST NAME                            | REFERENCE              | TEST CONDITIONS                                                      | PERFORMANCE REQUIREMENTS                                                                                                                         |
| 1                                                              | Pre- and post-stress electrical test | User spec.             | -                                                                    | -                                                                                                                                                |
| 2                                                              | High temperature exposure (storage)  | MIL-STD 202 method 108 | 1000 h; 105 °C; unpowered                                            | $ \Delta C/C  \leq \pm 5\%$<br>Increase of $\tan \delta$<br>0.008 for $C \leq 1 \mu\text{F}$ at 10 kHz<br>$IR \geq 50\%$ of initial requirement  |
| 3                                                              | Temperature cycling                  | JESD22 method JA-104   | 1000 cycles: -55 °C to +105 °C<br>10 min. dwell time each            | $ \Delta C/C  \leq \pm 5\%$<br>Increase of $\tan \delta = 0.008$ at 10 kHz<br>$IR \geq 50\%$ of initial requirement                              |
| 4                                                              | Moisture resistance                  | MIL-STD 202 method 106 | 10 cycles at 24 h/cycle unpowered                                    | $ \Delta C/C  \leq \pm 5\%$<br>Increase of $\tan \delta$<br>0.008 for $C \leq 1 \mu\text{F}$ at 10 kHz<br>$IR \geq 50\%$ of initial requirement  |
| 5                                                              | Biased humidity                      | MIL-STD 202 method 103 | 1000 h; 40 °C; 93 % RH with $U_{RAC}$                                | $ \Delta C/C  \leq \pm 10\%$<br>Increase of $\tan \delta$<br>0.008 for $C \leq 1 \mu\text{F}$ at 10 kHz<br>$IR \geq 50\%$ of initial requirement |
| 6                                                              | Operational life                     | MIL-STD 202 method 108 | $T_{amb} = 105\text{ °C}$ ;<br>1000 h; $U_{test} = 1 \times U_{RAC}$ | $ \Delta C/C  \leq \pm 10\%$<br>Increase of $\tan \delta$<br>0.008 for $C \leq 1 \mu\text{F}$ at 10 kHz<br>$IR \geq 50\%$ of initial requirement |
| 7                                                              | Terminal strength (lead)             | MIL-STD 202 method 211 | Leaded device lead integrity only.                                   | $ \Delta C/C  \leq \pm 5\%$<br>Increase of $\tan \delta$<br>0.008 for $C \leq 1 \mu\text{F}$ at 10 kHz<br>$IR =$ initial requirement             |
| 8                                                              | Resistance to solvents               | MIL-STD 202 method 215 | Short term                                                           | No visual damage<br>Legible marking                                                                                                              |
| 9                                                              | Mechanical shock                     | MIL-STD 202 method 213 | Figure a of method 213, condition C                                  | No visual damage                                                                                                                                 |
| 10                                                             | Vibration                            | MIL-STD 202 method 204 | 5 g's for 20 min;<br>12 cycles, 3 orientations                       | No visual damage                                                                                                                                 |
| 11                                                             | Resistance to soldering heat         | MIL-STD 202 method 210 | 260 °C; 10 s                                                         | $ \Delta C/C  \leq \pm 5\%$<br>Increase of $\tan \delta$<br>0.008 for $C \leq 1 \mu\text{F}$ at 10 kHz<br>$IR =$ initial requirement             |
| 12                                                             | Solderability                        | J-STD-002              | 235 °C / 5 s                                                         | Good tinning as evidence by free flowing of the solder with wetting of terminations > 95 %                                                       |
| 13                                                             | Electrical characterization          | User spec.             | -                                                                    | User spec.                                                                                                                                       |
| 14                                                             | Flammability                         | UL 94                  | Electrical test not required                                         | Maximum permitted burning time < 10 s                                                                                                            |



## Disclaimer

ALL PRODUCT, PRODUCT SPECIFICATIONS AND DATA ARE SUBJECT TO CHANGE WITHOUT NOTICE TO IMPROVE RELIABILITY, FUNCTION OR DESIGN OR OTHERWISE.

Vishay Intertechnology, Inc., its affiliates, agents, and employees, and all persons acting on its or their behalf (collectively, "Vishay"), disclaim any and all liability for any errors, inaccuracies or incompleteness contained in any datasheet or in any other disclosure relating to any product.

Vishay makes no warranty, representation or guarantee regarding the suitability of the products for any particular purpose or the continuing production of any product. To the maximum extent permitted by applicable law, Vishay disclaims (i) any and all liability arising out of the application or use of any product, (ii) any and all liability, including without limitation special, consequential or incidental damages, and (iii) any and all implied warranties, including warranties of fitness for particular purpose, non-infringement and merchantability.

Statements regarding the suitability of products for certain types of applications are based on Vishay's knowledge of typical requirements that are often placed on Vishay products in generic applications. Such statements are not binding statements about the suitability of products for a particular application. It is the customer's responsibility to validate that a particular product with the properties described in the product specification is suitable for use in a particular application. Parameters provided in datasheets and / or specifications may vary in different applications and performance may vary over time. All operating parameters, including typical parameters, must be validated for each customer application by the customer's technical experts. Product specifications do not expand or otherwise modify Vishay's terms and conditions of purchase, including but not limited to the warranty expressed therein.

Hyperlinks included in this datasheet may direct users to third-party websites. These links are provided as a convenience and for informational purposes only. Inclusion of these hyperlinks does not constitute an endorsement or an approval by Vishay of any of the products, services or opinions of the corporation, organization or individual associated with the third-party website. Vishay disclaims any and all liability and bears no responsibility for the accuracy, legality or content of the third-party website or for that of subsequent links.

Except as expressly indicated in writing, Vishay products are not designed for use in medical, life-saving, or life-sustaining applications or for any other application in which the failure of the Vishay product could result in personal injury or death. Customers using or selling Vishay products not expressly indicated for use in such applications do so at their own risk. Please contact authorized Vishay personnel to obtain written terms and conditions regarding products designed for such applications.

No license, express or implied, by estoppel or otherwise, to any intellectual property rights is granted by this document or by any conduct of Vishay. Product names and markings noted herein may be trademarks of their respective owners.