



15ACEW_4 series

15Watt - AC-DC converter

AC-DC Converter

15 Watt

- ⊕ Ultra-wide 85-305VAC and 100-430VDC input voltage range
- ⊕ Operating ambient temperature range: -40°C to +85°C
- ⊕ Up to 86% efficiency
- ⊕ No-load power consumption 0.1W
- ⊕ 5000m altitude application
- ⊕ OVCIII (meet EN61558-1)
- ⊕ EMI performance meets CISPR32/EN55032 CLASS B, EN55014
- ⊕ IEC/EN/UL62368/EN60335/EN61558 safety approval
- ⊕ Design to meet IEC/EN60601-1/ANSI/AAMI ES60601-1 standards (2xMOPP)

15ACEW_4 series AC-DC converters is one of GAPTEC's new generation compact size power converter. It features ultra-wide AC input and at the same time accepts DC input voltage, low power consumption, low ripple & noise, high efficiency, high reliability, reinforced isolation. It offers good EMC performance compliant to IEC/EN61000-4 and CISPR32/EN55032 and meets IEC/EN/UL62368/EN60335/EN61558/IEC/EN60601-1/ANSI/AAMI ES60601-1 standards. The converters are widely used in industrial, power, medical treatment, home appliances, instrumentation, communication and civil applications. For extremely harsh EMC environment, we recommend using the application circuit show in Design Reference of this datasheet.



Common specifications		Min	Typ	Max	Units
Item	Operating condition				
Short circuit protection:		Hiccup, continuous, self-recovery			
Cooling:		Free air convection			
Operating temperature:		-40		+85	°C
Operation temperature range:	Wave-soldering Manual-welding	260 ± 5°C; time: 5 - 10s 360 ± 10°C; time: 3 - 5s			
Storage humidity:				< 95	%RH
Switching Frequency			65		kHz
Power derating:	+50°C to +70°C: 3.3V/5.0	3.0			%/°C
	+55°C to +70°C: 9/12/15/24V	2.67			%/°C
	+70°C to +85°C	0.66			%/°C
	85VAC - 100VAC:	1.33			%/°VAC
	277VAC - 305VAC: 2000m - 5000m:	0.71 0.67			%/°VAC %/Km
Safety standard:		IEC/EN/UL62368/EN60335/ EN61558/IEC/EN60601-1/ANSI/ AAMI ES60601-1			
Safety Certification:		IEC/EN/UL62368/EN60335/ EN61558			
Safety Class:		Class II			
MTBF:		MIL-HDBK-217F@25°C > 3200,000 h			
Hot plug:		Unavailable			
Case material:		Black plastic, flame-retardant and heat-resistant (UL94V-0)			
Designed Life: (230VAC)	Ta: 25°C 100% load Ta: 55°C 100% load	>130x10 ³ h >27x10 ³ h			
Dimension	DIP package	47.60 x 26.80 x 23.50 mm			
	Chasis mounting	76.00 x 31.50 x 32.30 mm			
	DIN-rail mounting	76.00 x 31.50 x 36.90 mm			
Weight: (DIP)	3.3V/5V/9V/12V 15V/24V	48			g
Weight: (Chasis mounting)		68			g
Weight: (DIN rail mounting)		88			g

Input specifications		Min	Typ	Max	Units
Item	Operating condition				
Input voltage range	• AC Input	85		305	VAC
	• DC Input	100		430	VDC
Input frequency		47		63	Hz
Input current	• 115VAC			0.45	A
	• 230VAC			0.30	A
Inrush current	• 230VAC		30		A
Leakage Current	277VAC/50Hz		0.1mA RMS Max.		
Built In Fuse			2A/300V, slow-blow		

Isolation specifications		Min	Typ	Max	Units
Item	Operating Conditions				
Isolation (Input-Output)	Electric Strength Test for 1min, leakage current <5mA	4000			VAC

Example:

15ACEW_03S4

**15 = 15Watt; AC = AC-DC; E = case style ; W = wide input
03 = 3.3Vout; S = single output; 4 = 4 kVAC isolation**

Note:

1. If the product is not operated within the required load range, the product performance cannot be guaranteed to comply with all parameters in the datasheet;
2. Unless otherwise specified, parameters in this datasheet were measured under the conditions of Ta = 25°C, humidity <75% with nominal input voltage and rated output load;
3. All index testing methods in this datasheet are based on our company corporate standards;
4. We can provide product customization service, please contact our technicians directly for specific information;
5. Products are related to laws and regulations: see "Features" and "EMC";
6. Our products shall be classified according to ISO14001 and related environmental laws and regulations, and shall be handled by qualified units.

15ACEW_4 series

15Watt - AC-DC converter

Output specifications						
Item	Operating condition	Min	Typ	Max	Units	
Output voltage accuracy			±2		%	
Line regulation	Full load		±0.5		%	
Load regulation	0% - 100% load		±1		%	
Ripple & Noise*	20MHz bandwidth (peak-to-peak value)		70	120	mV	
Stand-by Power Consumption	230VAC: 3.3/5/9/12/15V		0.1		W	
	230VAC: 24V		0.12		W	
Temperature Coefficient			±0.02		%/°C	
Over-current Protection			≥110%Io, self-recovery			
Over-voltage Protection	3.3/5VDC output		≤7.5VDC			
	9VDC output		≤15VDC			
	12/15VDC output		≤20VDC			
	24VDC output		≤30VDC			
Min. load		0			%	
Hold-up Time	115VAC input		10		ms	
	230VAC input		55		ms	

Note: *The "Tip and barrel method" is used for ripple and noise test, output parallel 10uF electrolytic capacitor and 1uF ceramic capacitor, please refer to AC-DC Converter Application Notes for specific information.

Product Selection Guide

Approval	Model	Power [W]	Output [Vo]	Output [Io]	Efficiency [%, typ]	Capacitive load [μF, max]
UL	15ACEW_03S4	13.2	3.3V	4000mA	82	6000
UL	15ACEW_05S4	15	5V	3000mA	85	5000
UL	15ACEW_09S4	15	9V	1670mA	84	3000
UL	15ACEW_12S4	15	12V	1250mA	85	2000
UL	15ACEW_15S4	15	15V	1000mA	85	1500
UL	15ACEW_24S4	15	24V	625mA	86	680

Note: * Use suffix "CM" for chassis and suffix "DR" for DIN-Rail mounting = 15ACEW_24S4/**CM**.

EMC specifications						
Emissions	CE	CISPR32/EN55032 CLASS B CISPR11/EN55011 CLASS B EN55014-1				
Emissions	RE	CISPR32/EN55032 CLASS B CISPR11/EN55011 CLASS B EN55014-1				
Immunity	ESD	IEC/EN 61000-4-2 IEC/EN55014-2	Contact ±6KV/Air ±8KV	perf. Criteria B perf. Criteria B		
Immunity	RS	IEC/EN 61000-4-3 IEC/EN55014-2	10V/m	perf. Criteria A perf. Criteria B		
Immunity	EFT	IEC/EN61000-4-4 ±2KV IEC/EN61000-4-4 ±4KV (See Fig.2 for recommended circuit) EN55014-2		perf. Criteria B perf. Criteria B perf. Criteria B		
Immunity	Surge	IEC/EN61000-4-5 line to line ±1KV (See Fig.1 for typical application circuit) IEC/EN61000-4-5 line to line ±2KV (See Fig.2 for recommended circuit) EN55014-2		perf. Criteria B perf. Criteria B perf. Criteria B		
Immunity	CS	IEC/EN 61000-4-6 EN55014-2	10 Vr.m.s	perf. Criteria A perf. Criteria A		
Immunity	Voltage dip, short interruption and voltage variation	IEC/EN 61000-4-11 EN55014-2	0%-70%	perf. Criteria B perf. Criteria B		

15ACEW_4 series

15Watt - AC-DC converter

Product Characteristic Curve

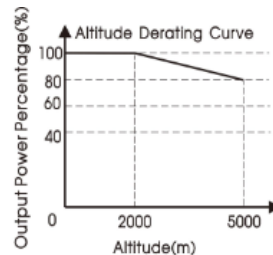
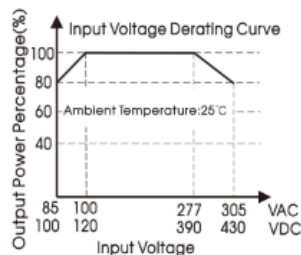
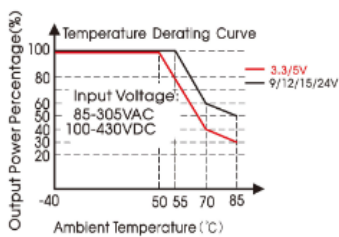

Note:

- ① With an AC input between 85-100V/277-305VAC and a DC input between 100-120V/390-430VDC, the output power must be derated as per temperature derating curves;
- ② This product is suitable for applications using natural air cooling; for applications in closed environment please consult factory or one of our FAE.

Efficiency

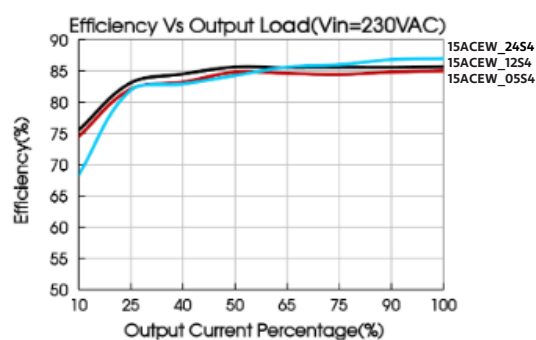
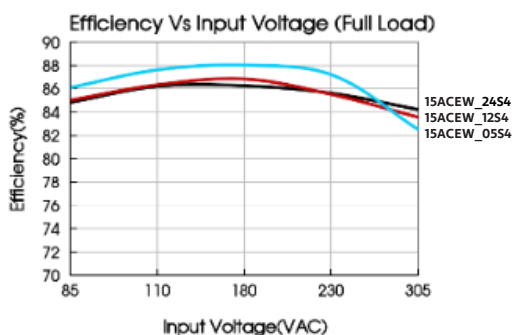

Typical application

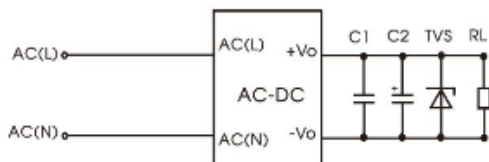

Fig. 1: Typical circuit diagram

Part No.	C1 (μF)	C2 (μF)	TVS
15ACEW_0354	1μF/50V	220μF/16V	SMBJ7.0A
15ACEW_0554		220μF/16V	SMBJ7.0A
15ACEW_0954		100μF/25V	SMBJ12A
15ACEW_1254		100μF/25V	SMBJ20A
15ACEW_1554		100μF/25V	SMBJ20A
15ACEW_2454		100μF/25V	SMBJ30A

Output Filter Components:

We recommend using an electrolytic capacitor with high frequency, and low ESR rating for C2 (refer to manufacture's datasheet). Choose a Capacitor voltage rating with at least 20% margin, in other words not exceeding 80%. C1 is a ceramic capacitor used for filtering high-frequency noise and TVS is a recommended suppressor diode to protect the application in case of a converter failure

EMC compliance recommended

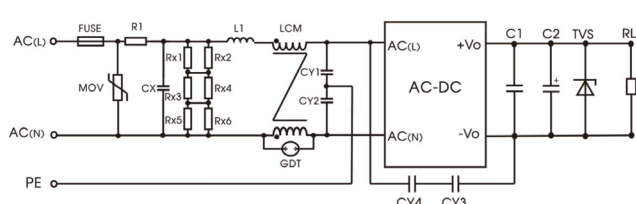

Component	Recommended value
FUSE	3.15A/300V, slow-blow, required
MOV	S14K350
CX	334K/305VAC
R1	12Ω /5W (wire-wound resistor, required)
L1	1.2mH/0.5A
CY1/CY2	2.2nF/400VAC
CY3/CY4	1nF/400VAC
GDT	300V/1KA
LCM	20 mH

Note: Rx1/Rx2/Rx3/Rx4/Rx5/Rx6 is the bleeder resistance of CX, and the recommended resistance value is 1.5MΩ /150VDC.

Dimensions and Recommended Layout

THIRD ANGLE PROJECTION 

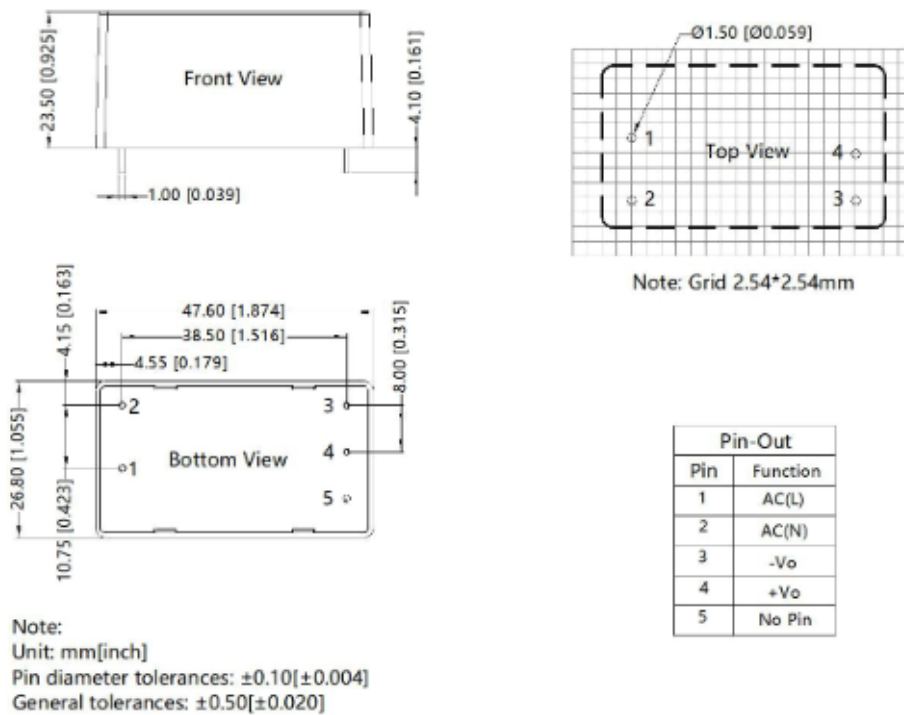

Chassis mounting

THIRD ANGLE PROJECTION 

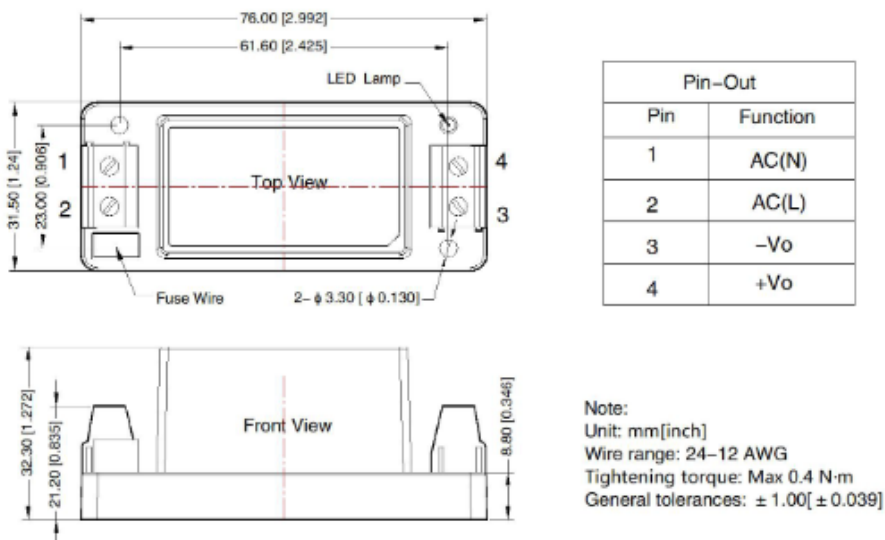

15ACEW_4 series

15Watt - AC-DC converter

DIN rail mounting

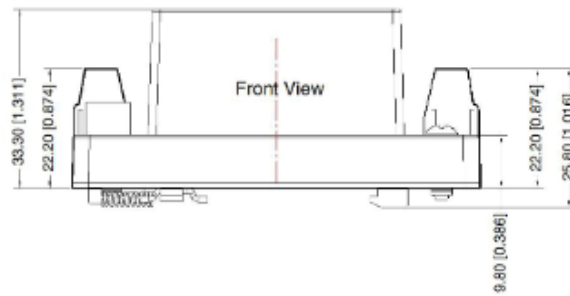
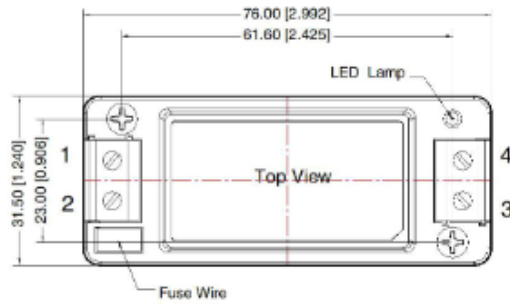

THIRD ANGLE PROJECTION

Pin-Out	
Pin	Function
1	AC(N)
2	AC(L)
3	-Vo
4	+Vo

Note:
Unit: mm[inch]
Wire range: 24-12 AWG
Tightening torque: Max 0.4 N-m
Mounting rail: TS35, rail needs to connect safety ground
General tolerances: $\pm 1.00 [\pm 0.039]$