

100QBW4_2.25 series

100W Quarter-Brick - Single Output DC-DC Converter - Ultra-Wide Input - Isolated & Regulated

24V in DC-DC Converter 100 Watt

- ⊕ Ultrawide 4:1 input voltage range
- ⊕ High efficiency up to 90%
- ⊕ I/O isolation test voltage: 2.25kVDC
- ⊕ Input under-voltage protection, output short-circuit, over-current, over-voltage, over-temperature protection
- ⊕ Operating ambient temp. range: -40°C to +85°C
- ⊕ Five-sided metal shielded package
- ⊕ Industry standard ¼-Brick package and pin-out
- ⊕ EN62368 approved
- ⊕ Meets UL62368, IEC62368, EN50155 standards

The 100QBW4_24_2.25 series of isolated 100W DC-DC products with 4:1 input voltage. They feature efficiency up to 90%, 2250VDC input to output isolation, operating ambient temperature of -40°C to +85°C, input under-voltage, output over-voltage, short-circuit, over-current protection, over-temperature protection. The products meet CLASS B of CISPR32/EN55032 EMI standards by adding the recommended external components, and they are widely used in applications such as battery powered systems, industrial controls, electricity, instrumentation, railway, communication.



UL-62368-1 (E347551)

Common specifications	
Short circuit protection:	Hiccup, continuous, self-recovery
Operation temperature:	-40°C~+85°C
Storage temperature:	-55°C ~+125°C
Over temperature protection:	+115°C TYP / +120°C MAX
Pin welding resistance temperature:	260°C MAX, Wave-soldering 10sec. 300°C MAX, 1.5mm from case for 10sec.
Storage humidity:	5% ~ 95%
Vibration:	IEC/EN61373 - Category 1, Grade B
Trim:	• 91%Vo MIN, 110%Vo MAX (5, 15V output) • 90%Vo MIN, 110%Vo MAX (Others)
Sense:	110%Vo MAX
Thermal Resistance (Natural convection)	8 °C/W 6.8 °C/W 5.7 °C/W
MTBF (MIL-HDBK-217F@25 °C)	500,000 hours
Case material:	Aluminum alloy case; Black plastic bottom, flame-retardant and heat-resistant (UL94 V-0)
Cooling:	Natural air convection or forced convection
Dimensions	61.8 × 40.2 × 12.7 mm 62.0 × 56.0 × 14.6 mm (aluminum baseplate) 61.8 × 40.2 × 27.7 mm (heatsink)
Weight:	86g TYP 90g TYP (aluminum baseplate) 117.0g TYP (heatsink)

Input specifications					
Item	Test condition	Min	Typ	Max	Units
Input current	full load/no load Nominal input voltage		4682/ 120	4789/ 160	mA
Reflected ripple current	Nominal input voltage		30		mA
Surge voltage	1sec. max.	-0.7		50	VDC
Start-up Voltage		0.7	7.5		VDC
Input under voltage protection		0.7	7.5		VDC
Input filter	Pi filter				
Hot plug	Unavailable				
Ctrl (The Ctrl pin voltage is referenced to input GND.)	• Module switch ON • Module switch OFF • Input current when switched OFF		Ctrl pin open or pulled high (3.5-12VDC) Ctrl pin pulled low to GND (0-1.2VDC) 2	10	mA

Output specifications					
Item	Test condition	Min	Typ	Max	Units
voltage accuracy	0%-100% load		±1	±3	%
Line regulation	Input voltage variation from low to high at full load		±0.2	±0.5	%
Load regulation	5%-100% load		±0.5	±0.75	%
Transient recovery time	25% load step change		200	500	µs
Transient response deviation	25% load step change • 5V output • others		±3 ±3	±7.5 ±5	%
Temperature coefficient				±0.03	%/°C
Ripple & Noise*	20MHz Bandwidth • 12V/15V output • others		100 130	200 250	mVp-p mVp-p
Output over-voltage protection	Input voltage range	110	125	160	%Vo
Output over-current protection	Input voltage range	110	125	150	%Io
Switching frequency	PFM mode		250		KHz

*The "parallel cable" method is used for ripple and noise test, please see DC-DC Converter Application Notes for specific operation.

Isolation specifications					
Item	Test condition	Min	Typ	Max	Units
Isolation voltage	Tested for 1 minute and leak current of 1mA max. • Input-output • Input-case • Output-case			2250 1600 500	VDC VDC VDC
Isolation resistance	Insulation voltage 500VDC	100			MΩ
Isolation capacitance	Input-output, 100KHz/0.1V		2200		pF

Example:
100QBW4_2405S2.25
100 = 100 Watt; QB = Quarter-Brick; W4 = Wide input (4:1);
24 = 9-36Vin; 05 = 5Vout; S = Single Output; 2.25= 2.25kVDC isolation

Note:

- Operation under minimum load will not damage the converter; However, they may not meet all specification listed, and that will reduce the life of product.
- All specifications measured at Ta = 25°C, humidity <75%, nominal input voltage and rated output load unless otherwise specified.
- In this datasheet, all the test methods of indications are based on corporate standards.

100QBW4_2.25 series

100W Quarter-Brick - Single Output DC-DC Converter - Ultra-Wide Input - Isolated & Regulated

EMC specifications			
Emissions	CE	CISPR32/EN55032 CLASS A and CLASS B (see Fig. 3 for recommended circuit)	
Emissions	RE	CISPR32/EN55032 CLASS A and CLASS B (see Fig. 3 for recommended circuit)	
Immunity	ESD	IEC/EN61000-4-2 Contact ±6KV Air ±8KV	perf.Criteria B
Immunity	RS	IEC/EN61000-4-3 20V/m	perf.Criteria A
Immunity	EFT	IEC/EN61000-4-4 ±2KV(see Fig. 2 for recommended circuit)	perf.Criteria A
Immunity	CS	IEC/EN61000-4-6 10 Vr.m.s	perf.Criteria A

EMC specifications (EN50155)		
Emissions	CE	EN50121-3-2 150kHz-500kHz 99dBuV (see Fig.3 for recommended circuit) EN55016-2-1 500kHz-30MHz 93dBuV
Emissions	RE	EN50121-3-2 30MHz-230MHz 40dBuV/m at 10m (see Fig.3 for recommended circuit) EN55016-2-1 230MHz-1GHz 47dBuV/m at 10m
Immunity	ESD	EN50121-3-2 Contact ±6KV/Air ±8KV
Immunity	RS	EN50121-3-2 80MHz-800MHz 20V/m(rms)
Immunity	EFT	EN50121-3-2 ±2kV 5/50ns 5kHz (see Fig.2 for recommended circuit)
Immunity	Surge	EN50121-3-2 line to line ±1KV (42Ω 0.5uF see Fig.2 for recommended circuit)
Immunity	CS	EN50121-3-2 0.15MHz-80MHz 10V(rms)

Certification	Part Number	Input Voltage [V]			Output Voltage [VDC]	Output Current [A, max]	Full Load Efficiency [%Min/Typ]	Capacitive load [μF, max]
		Nominal	Range	Max				
UL	100QBW4_2405S2.25	24	9-36	40	5	20	87/89	6000
UL	100QBW4_2412S2.25	24	9-36	40	12	8.3	88/90	2000
UL	100QBW4_2415S2.25	24	9-36	40	15	6.7	88/90	2000
UL	100QBW4_2424S2.25	24	9-36	40	24	4.2	88/90	1000
UL	100QBW4_2428S2.25	24	9-36	40	28	3.6	88/90	1000
UL	100QBW4_2448S2.25	24	9-36	40	48	2.1	88/90	470

Please add suffix /BP (100QBWRW4_2448S2.25/BP) for base plate version and suffix /HS (100QBWRW4_2448S2.25/HS) for heat sink version.

Temperature derating curves

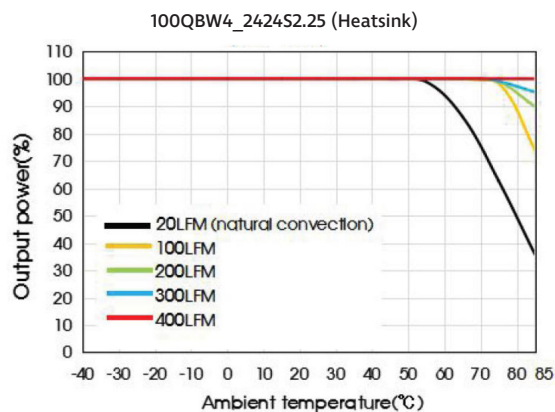
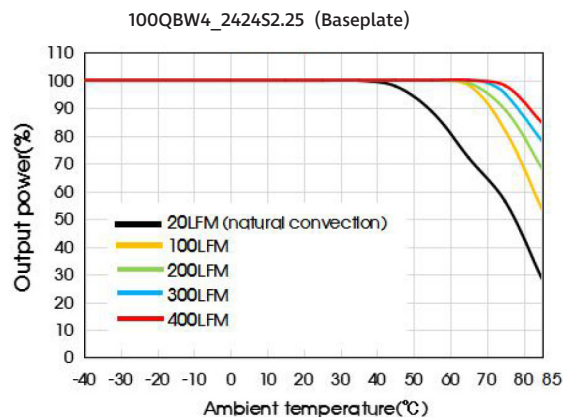
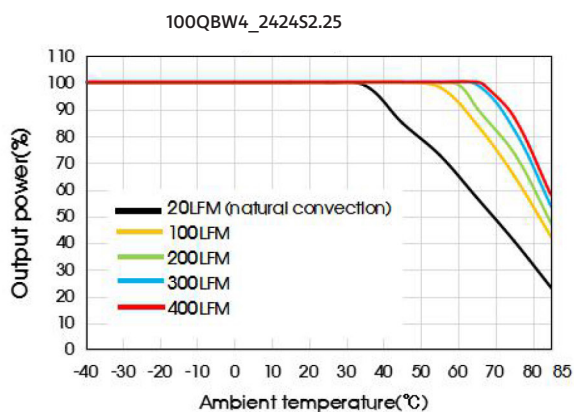

100QBW4_2.25 series

100W Quarter-Brick - Single Output DC-DC Converter - Ultra-Wide Input - Isolated & Regulated

Efficiency

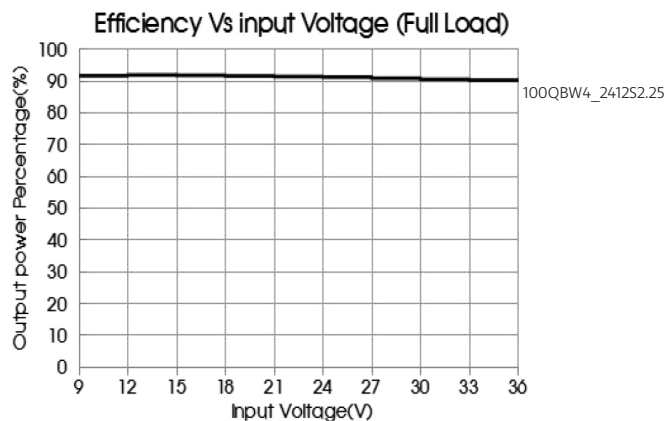
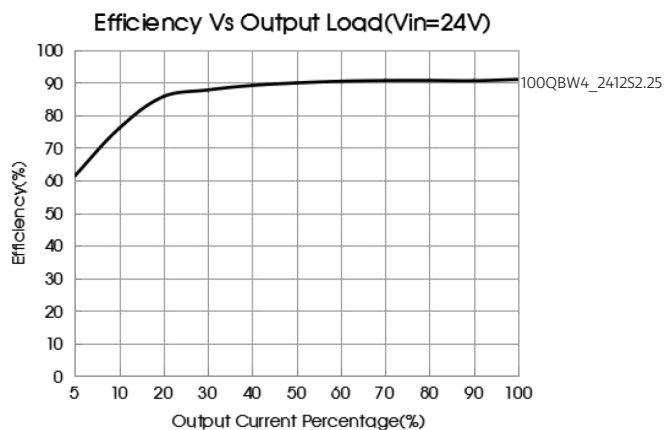

Sense of application and precautions

When not using remote sense

Notes:

- (1) If the sense function is not used for remote regulation the user must connect the +Sense to +Vo and -Sense to 0V at the DC-DC converter pins and will compensate for voltage drop across pins only.
- (2) The connections between sense lines and their respective power lines must be kept as short as possible, otherwise they may be picking up noise, interference and/or causing unstable operation of the power module.

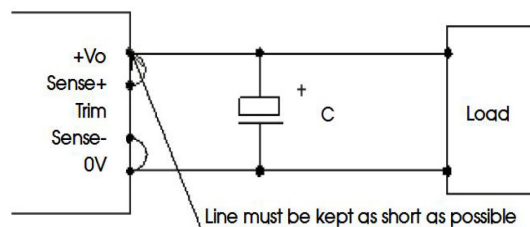

When remote sense is used

Notes:

- (1) Using remote sense with long wires may cause unstable output, please contact technical support if long wires must be used.
- (2) PCB-tracks or cables/wires for Remote Sense must be kept as short as possible. Twisted pair or shielded wires are suggested for remote compensation and must be kept as short as possible.
- (3) We recommend using adequate cross section for PCB-track layout and/or cables to connect the power supply module to the load in order to keep the voltage drop below 0.3V and to make sure the power supply's output voltage remains within the specified range.
- (4) Note that large wire impedance may cause oscillation of the output voltage and/or increased ripple. Consult technical support or factory for further advice of sense operation.

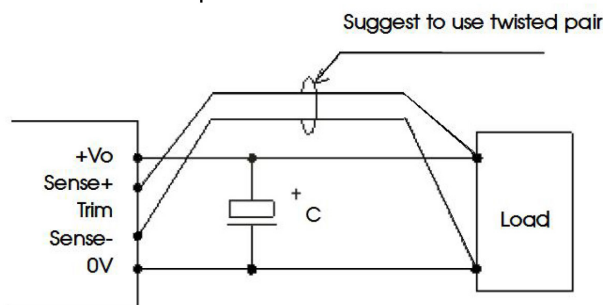

Typical application

- (1) We recommended using the recommended circuit shown in Fig.1 during product testing and application, otherwise please ensure that at least a 220µF electrolytic capacitors is connected at the input in order to ensure adequate voltage surge suppression and protection.
- (2) We recommended increasing the value of Cin and pay attention to the unstable input voltage if the product input side is paralleled with motor drive circuit and/or larger energy transient circuits, to ensure the stability of input terminal and avoid repeatedly start-up problems due to input voltage lower than undervoltage protection point.
- (3) We recommended increasing the output capacitance with limited to the capacitive load specification and/or increasing the voltage clamping circuit (such as TVS) if the output terminal is inductive device such as relay or a motor, to ensure adequate voltage surge suppression and protection.
- (4) Input and/or output ripple can be further reduced by appropriately increasing the input & output capacitor values Cin and Cout and/or by selecting capacitors with a low ESR (equivalent series resistance). Also make sure that the capacitance is not exceeding the specified max. capacitive load value of the product.



Fig.1

Vout (VDC)	Fuse	Cin	Cout	TVS
5	20A, slow blow	220µF	470µF	SMDJ7.0A
12		220µF	220µF	SMDJ15A
15		220µF	220µF	SMDJ18A
24		220µF	100µF	SMDJ30A
28		220µF	100µF	SMDJ36A
48		220µF	100µF	SMDJ64A

Note: *Please pay attention to the ambient temperature of the product when using an external capacitor, increase the electrolytic capacitor values to at least 1.5 times the original parameter if the ambient temperature is low (such as -25°C).

100QBW4_2.25 series

100W Quarter-Brick - Single Output DC-DC Converter - Ultra-Wide Input - Isolated & Regulated

EMC solution recommended circuit

We recommended using the recommended circuit shown in Fig.2 during product EMC testing and application.

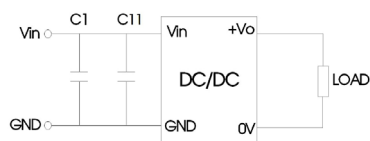

Fig. 2

Capacitor	Recommended value	Function
C1	150µF electrolytic capacitor	Meets EFT and surge
C11	47µF electrolytic capacitor	

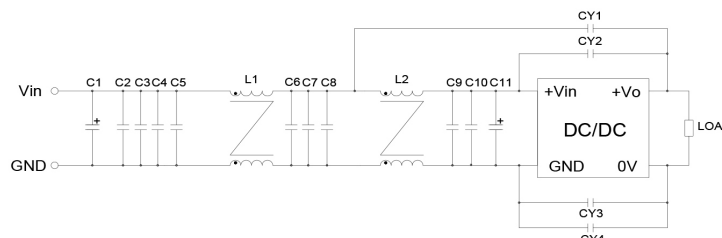
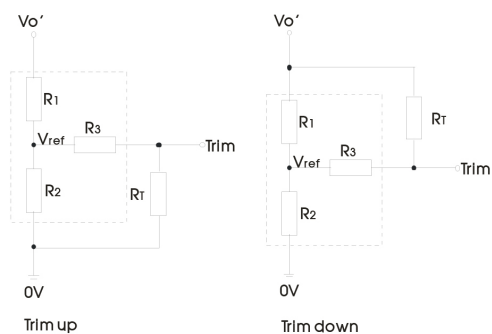

Fig. 3

CLASS A components	CLASS B components	Device parameter	Function
C1		150µF electrolytic capacitor	Meets conducted emission and radiated emission
C11		47µF electrolytic capacitor	
C2, C3, C4, C5, C6, C7, C8, C9, C10		10µF ceramic capacitor	
L1, L2		1.6mH common mode inductor	
CY3	CY1, CY2	2.2µF ceramic capacitor	
CY3	CY3, CY4	1nF Y1safety capacitor	

Trim application & trim resistance



TRIM resistor connection (dashed line shows internal resistor network)

Calculation formula of Trim resistance:

$$\text{up: } R_T = \frac{aR_2}{R_2 - a} - R_3 \quad a = \frac{V_{ref}}{V_o' - V_{ref}} \cdot R_1$$

$$\text{down: } R_T = \frac{aR_1}{R_1 - a} - R_3 \quad a = \frac{V_o' - V_{ref}}{V_{ref}} \cdot R_2$$

R_T = Trim Resistor value; a = self-defined parameter
 V_o' = desired output voltage ($\pm 10\%$ max.)

Vout(VDC)	R1(KΩ)	R2(KΩ)	R3(KΩ)	Vref(V)
5	3.036	3	10	2.5
12	11.000	2.87	15	2.5
15	14.03	2.8	15	2.5
24	24.872	2.87	15	2.5
28	29.201	2.851	15	2.5
48	53.017	2.913	15	2.5

Note: If the Trim pin is shorted with "+Vo", or its value is too low, then the output voltage V_o' would be lower than $0.90V_o$, which may cause permanent damage.

Reflected ripple current--test circuit

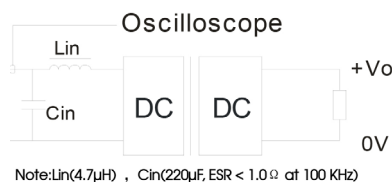

100QBW4_2.25 series

100W Quarter-Brick - Single Output DC-DC Converter - Ultra-Wide Input - Isolated & Regulated

Mechanical dimensions and recommended layout

THIRD ANGLE PROJECTION

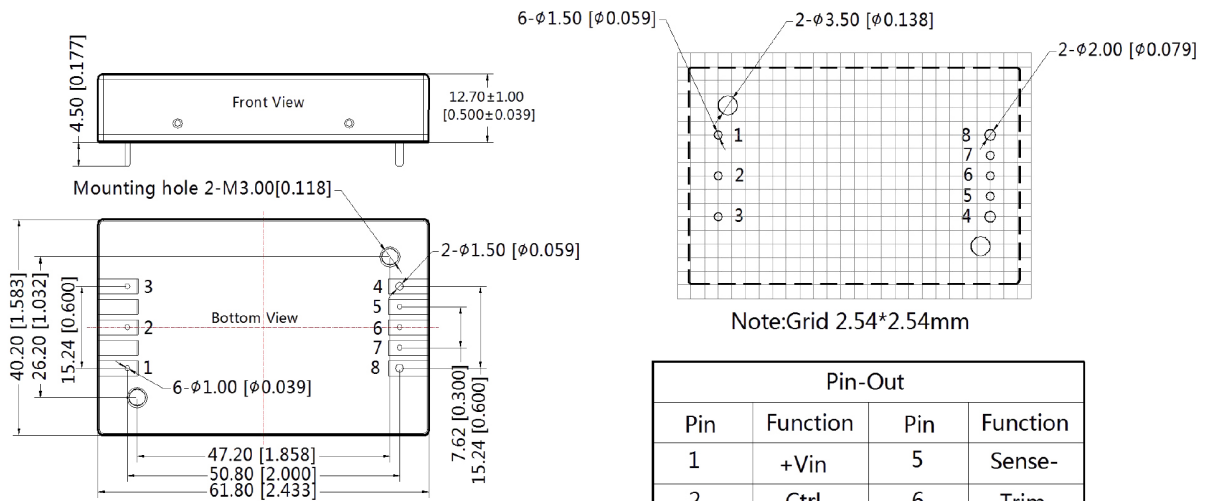

Note: Grid 2.54*2.54mm

Pin-Out			
Pin	Function	Pin	Function
1	+Vin	5	Sense-
2	Ctrl	6	Trim
3	-Vin	7	Sense+
4	0V	8	+Vo

Note:
 Unit: mm[inch]
 Pin1, 2, 3, 5, 6, 7's diameter: 1.00[0.039]
 Pin4, 8's diameter: 1.50[0.059]
 Pin diameter tolerances: ±0.10[±0.004]
 General tolerances: ±0.50[±0.020]
 Mounting hole screwing torque: Max 0.4 N·m

Base-plate dimensions and recommended layout (Base-plate)

THIRD ANGLE PROJECTION

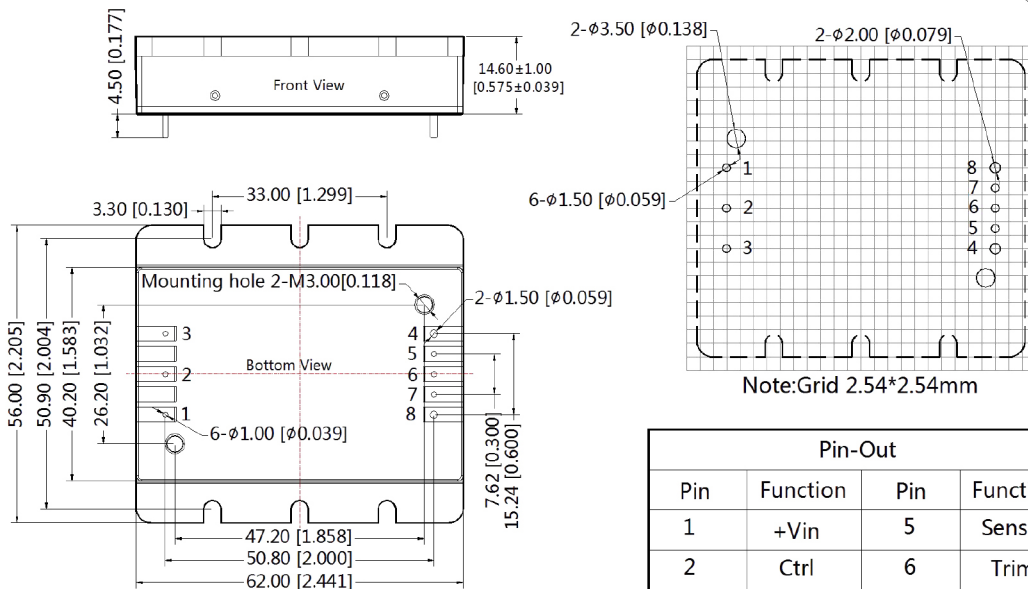

Note: Grid 2.54*2.54mm

Pin-Out			
Pin	Function	Pin	Function
1	+Vin	5	Sense-
2	Ctrl	6	Trim
3	-Vin	7	Sense+
4	0V	8	+Vo

Note:
 Unit: mm[inch]
 Pin1, 2, 3, 5, 6, 7's diameter: 1.00[0.039]
 Pin4, 8's diameter: 1.50[0.059]
 Pin diameter tolerances: ±0.10[±0.004]
 General tolerances: ±0.50[±0.020]
 Mounting hole screwing torque: Max 0.4 N·m

100QBW4_2.25 series

100W Quarter-Brick - Single Output DC-DC Converter - Ultra-Wide Input - Isolated & Regulated

Base-plate dimensions and recommended layout (Heatsink)

THIRD ANGLE PROJECTION 

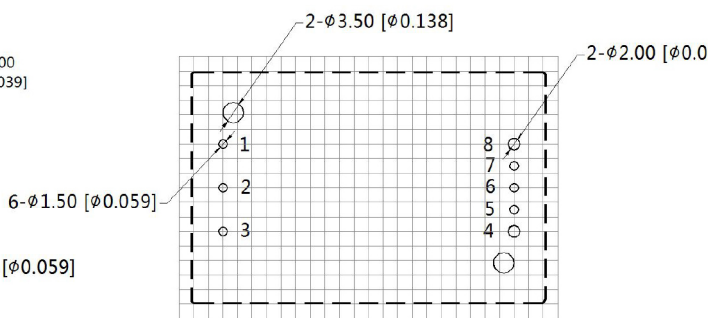
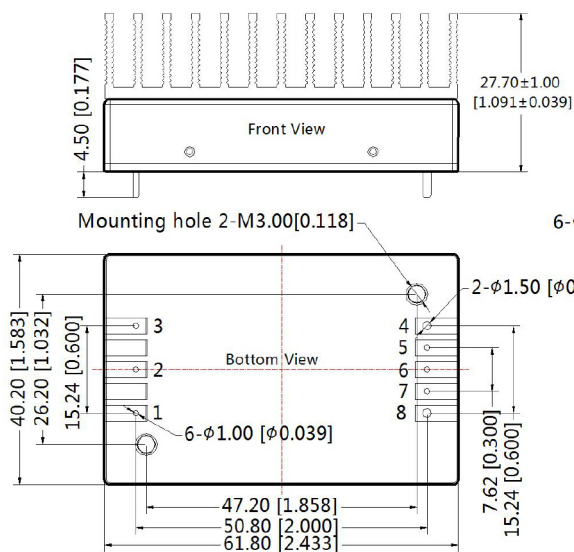

Note: Grid 2.54*2.54mm

Pin-Out			
Pin	Function	Pin	Function
1	+Vin	5	Sense-
2	Ctrl	6	Trim
3	-Vin	7	Sense+
4	0V	8	+Vo









Note:
 Unit: mm[inch]
 Pin1, 2, 3, 5, 6, 7's diameter: 1.00[0.039]
 Pin4, 8's diameter: 1.50[0.059]
 Pin diameter tolerances: ±0.10[±0.004]
 General tolerances: ±0.50[±0.020]
 Mounting hole screwing torque: Max 0.4 N·m



100QBW4_2.25 series

100W Quarter-Brick - Single Output DC-DC Converter - Ultra-Wide Input - Isolated & Regulated

48V in DC-DC Converter 100 Watt

-  **Ultrawide 4:1 input voltage range**
-  **High efficiency up to 94%**
-  **I/O isolation test voltage: 2.25kVDC**
-  **Operating ambient temp. range: -40°C to +85°C**
-  **EN62368 approved**
-  **Input under-voltage protection, output over-voltage,**
-  **over-current, short circuit, over-temperature protection**
-  **Industry standard ¼-Brick package and pin-out**
-  **Five-sided metal shielded package**

The 100QBW4_48_2.25 series are isolated 100W DC-DC products with 4:1 input voltage. They feature efficiency up to 94%, 2250VDC input to output isolation, operating temperature of -40°C to +85°C, input under-voltage, output over-voltage, over-current, short circuit, over-temperature protection. EN62368 approved and they are widely used in applications such as battery powered systems, industrial controls, electricity, instrumentation, railway, communication and intelligent robotics.



Common specifications	
Short circuit protection:	Hiccup, continuous, self-recovery
Operation temperature:	-40°C~+85°C
Storage temperature:	-55°C ~+125°C
Over temperature protection: (Max. Casing Temperature)	+95°C MIN; +105°C TYP; +115°C MAX
Pin welding resistance temperature:	260°C MAX, Wave-soldering 10sec. 300°C MAX, 1.5mm from case for 10sec.
Storage humidity:	5% ~ 95%
Trim:	95%Vo MIN, 110%Vo MAX
Sense:	105%Vo MAX
Vibration:	IEC/EN61373 train 1B category
MTBF (MIL-HDBK-217F@25 °C)	500,000 hours
Case material:	Aluminum alloy case; Black plastic bottom, flame-retardant and heat-resistant (UL94 V-0)
Cooling:	Natural air convection or forced convection
Dimensions	61.8 × 40.2 × 12.7 mm 62.0 × 56.0 × 14.6 mm (aluminum baseplate) 61.8 × 40.2 × 27.7 mm (heatsink)
Weight:	89g TYP 109g TYP (aluminum baseplate) 120.0g TYP (heatsink)

Output specifications					
Item	Test condition	Min	Typ	Max	Units
voltage accuracy	0%-100% load		±1	±3	%
Line regulation	Input voltage variation from low to high at full load		±0.2	±0.5	%
Load regulation	5%-100% load		±0.5	±0.75	%
Transient recovery time	25% load step change		200	500	µs
Transient response deviation	25% load step change • 3.3V/ 5V output • others		±3 ±3	±7.5 ±5	%
Temperature coefficient	Full load			±0.03	%/°C
Ripple & Noise*	20MHz Bandwidth • 12V/15V output • others		100 130	200 250	mVp-p mVp-p
Output over-voltage protection	Input voltage range	110	125	160	%Vo
Output over-current protection	Input voltage range	110	125	190	%Io
Switching frequency	PFM mode		250		KHz

*The "parallel cable" method is used for ripple and noise test, please see DC-DC Converter Application Notes for specific operation.

Input specifications					
Item	Test condition	Min	Typ	Max	Units
Input current	full load/no load Nominal input voltage • 3.3V output • Others		1776/50 2265/50	1812/80 2341/80	mA
Reflected ripple current	Nominal input voltage		30		mA
Surge voltage	1sec. max.	-0.7		90	VDC
Start-up Threshold Voltage				18	VDC
Input under voltage protection	• 05V/15V output • Others	16 15	16.5 15.5		VDC
Input filter	Pi filter				
Ctrl (The voltage of Ctrl pin is relative to input pin GND.)	• Module ON • Module OFF • Input current when OFF			Ctrl open circuit or connected to TTL high level (3.5-12VDC) Ctrl pin connected to GND or low level (0-1.2VDC) 2 10	mA
Hot plug	Unavailable				

Isolation specifications					
Item	Test condition	Min	Typ	Max	Units
Isolation voltage	Tested for 1 minute and leak current of 1mA max. • Input-output • Input-case • Output-case		2250 1500 500		VDC VDC VDC
Isolation resistance	Insulation voltage 500VDC	1000			MΩ
Isolation capacitance	Input-output, 100KHz/0.1V		2200		pF

Example:
100QBW4_480552.25
100 = 100 Watt; QB = Quarter-Brick; W4 = Wide input (4:1);
48 = 18-75 Vin; 05 = 5Vout; S = Single Output; 2.25 = 2.25kVDC isolation

Note:

- Operation under minimum load will not damage the converter; However, they may not meet all specification listed, and that will reduce the life of product.
- All specifications measured at Ta = 25°C, humidity <75%, nominal input voltage and rated output load unless otherwise specified.
- In this datasheet, all the test methods of indications are based on corporate standards.

100QBW4_2.25 series

100W Quarter-Brick - Single Output DC-DC Converter - Ultra-Wide Input - Isolated & Regulated

EMC specifications		
Emissions	CE	CISPR32/EN55032, EN50121-3-2 CLASS A and CLASS B (see Fig. 2 for recommended circuit)
Emissions	RE	CISPR32/EN55032, EN50121-3-2 CLASS A and CLASS B (see Fig. 2 for recommended circuit)
Immunity	ESD	IEC/EN61000-4-2, EN50121-3-2 Contact $\pm 6\text{KV}$ Air $\pm 8\text{KV}$ perf.Criteria B
Immunity	RS	IEC/EN61000-4-3, EN50121-3-2 10V/m perf.Criteria A
Immunity	EFT	IEC/EN61000-4-4, EN50121-3-2 $\pm 2\text{KV}$ (see Fig. 2 for recommended circuit) perf.Criteria A
Immunity	Surge	EN50121-3-2 differential mode $\pm 1\text{KV}$, 1.2/50us, source impedance 42Ω (see Fig.2 for recommended circuit) perf.Criteria B
Immunity	CS	IEC/EN61000-4-6, EN50121-3-2 10 Vr.m.s perf.Criteria A

Part Number	Input Voltage [V]			Output Voltage [VDC]	Output Current [A, max]	Full Load Efficiency [%Min/Typ]		Capacitive load [μF , max]
	Nominal	Range	Max			Vin=24V	Vin=48V	
100QBW4_4803S2.25	48	18-75	80	3.3	22.7	87/89	86/88	10000
100QBW4_4805S2.25	48	18-75	80	5	20	91/93	89/91	6000
100QBW4_4812S2.25	48	18-75	80	12	8.3	91/93	90/92	2000
100QBW4_4815S2.25	48	18-75	80	15	6.7	92/94	91/93	2000
100QBW4_4824S2.25	48	18-75	80	24	4.2	91/93	90/92	1000
100QBW4_4848S2.25	48	18-75	80	48	2.1	91/93	90/92	470

1. We recommend to choose modules with a heat sink for enhanced heat dissipation and applications with extreme temperature requirements;
2. Exceeding the maximum input voltage may cause permanent damage.

Please add suffix /BP (100QBW4_4848S2.25/BP) for base plate version and suffix /HS (100QBW4_4848S2.25/HS) for heat sink version.

Temperature derating curves

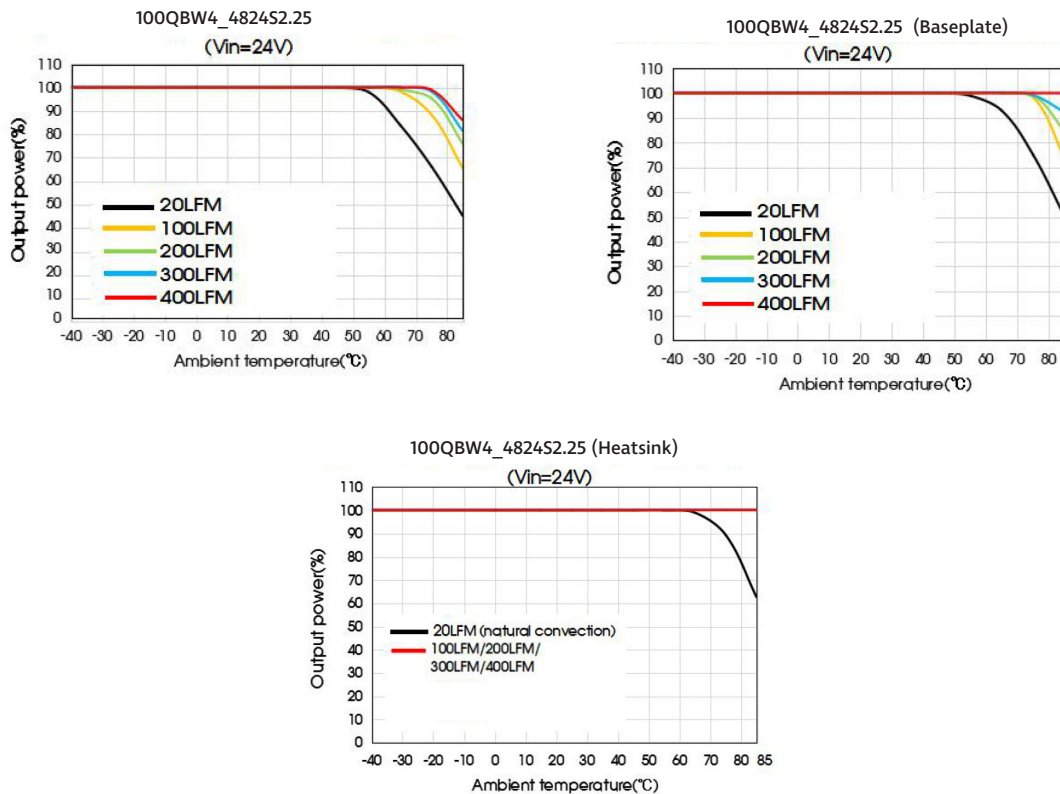

Product application thermal design should be referred to the recommended PCB layout and recommended heat dissipation structure, please see DC-DC Converter Application Notes for specific operation.

100QBW4_2.25 series

100W Quarter-Brick - Single Output DC-DC Converter - Ultra-Wide Input - Isolated & Regulated

Sense of application and precautions

When not using remote sense

Notes:

- (1) If the sense function is not used for remote regulation the user must connect the +Sense to +Vo and -Sense to 0V at the DC-DC converter pins and will compensate for voltage drop across pins only.
- (2) The connections between sense lines and their respective power lines must be kept as short as possible, otherwise they may be picking up noise, interference and/or causing unstable operation of the power module.

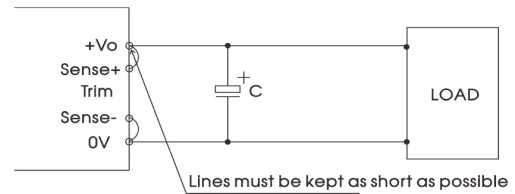

When remote sense is used

Notes:

- (1) PCB-tracks or cables/wires for Remote Sense must be kept as short as possible.
- (2) In cables and discrete wiring applications, twisted pair or other techniques should be implemented.
- (3) Using remote sense with long wires may cause unstable operation. Note that large wire impedance may cause oscillation of the output voltage and/or increased ripple. Consult technical support or factory for further advice of sense operation.
- (4) We recommend using adequate cross section for PCB-track layout and/or cables to connect the power supply module to the load in order to keep the voltage drop below 0.3V and to make sure the power supply's output voltage remains within the specified range.

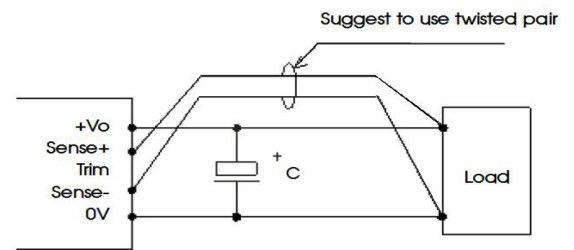

Typical application

- (1) We recommended using the recommended circuit shown in Fig.1 during product testing and application, otherwise please ensure that at least a 220 μ F electrolytic capacitors is connected at the input in order to ensure adequate voltage surge suppression and protection.
- (2) We recommended increasing the value of Cin and pay attention to the unstable input voltage if the product input side is paralleled with motor drive circuit and/or larger energy transient circuits, to ensure the stability of input terminal and avoid repeatedly start-up problems due to input voltage lower than undervoltage protection point.
- (3) We recommended increasing the output capacitance with limited to the capacitive load specification and/or increasing the voltage clamping circuit(such as TVS) if the output terminal is inductive device such as relay or a motor, to ensure adequate voltage surge suppression and protection.
- (4) Input and/or output ripple can be further reduced by appropriately increasing the input & output capacitor values Cin and Cout and/or by selecting capacitors with a low ESR (equivalent series resistance). Also make sure that the capacitance is not exceeding the specified max. capacitive load value of the product.



Fig.1

Vout (VDC)	Fuse	Cin	Cout	TVS
3.3	20A, slow blow	220 μ F	680 μ F	SMDJ6.0A
5		220 μ F	470 μ F	SMDJ6.0A
12		220 μ F	220 μ F	SMDJ14A
15		220 μ F	220 μ F	SMDJ17A
24		220 μ F	100 μ F	SMDJ28A
48		220 μ F	100 μ F	SMDJ54A

Note: *Please pay attention to the ambient temperature of the product when using an external capacitor, increase the electrolytic capacitor values to at least 1.5 times the original parameter if the ambient temperature is low(such as -25°C).

100QBW4_2.25 series

100W Quarter-Brick - Single Output DC-DC Converter - Ultra-Wide Input - Isolated & Regulated

EMC solution recommended circuit

We recommended using the recommended circuit shown in Fig.2 during product EMC testing and application.

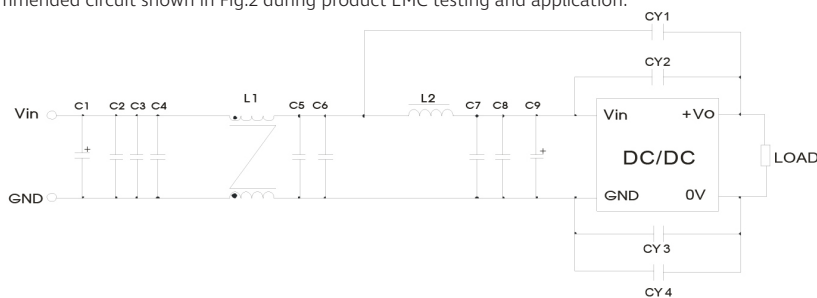
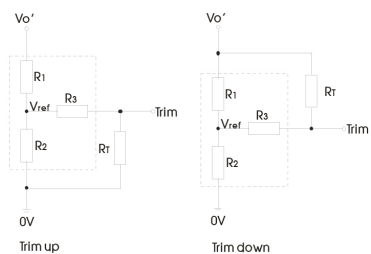

Fig. 2

CLASS A components	CLASS B components	Recommended Component value of 3.3V	Recommended Component value of 05-48V	Function
C1		150µF electrolytic capacitor	150µF electrolytic capacitor	Meet EFT and surge
C9		470µF electrolytic capacitor	47µF electrolytic capacitor	
C1		150µF electrolytic capacitor	150µF electrolytic capacitor	Meets conducted emission and radiated emission
C9		470µF electrolytic capacitor	47µF electrolytic capacitor	
C2, C3, C4, C5, C6, C7, C8		4.7µF ceramic capacitor	2.2µF ceramic capacitor	
L1		2mH, recommended to use	2mH, recommended to use	
L2		1.5µH inductance	1.5µH inductance	
CY1, CY2		1nF Y1 safety capacitor	1nF Y1 safety capacitor	
CY3	CY3, CY4	2.2nF Y1 safety capacitor	1nF Y1 safety capacitor	

Trim application & trim resistance



Calculation formula of Trim resistance:

$$\text{up: } R_t = \frac{\alpha R_2}{R_2 - \alpha} - R_3 \quad \alpha = \frac{V_{ref}}{V_o' - V_{ref}} \cdot R_1$$

$$\text{down: } R_t = \frac{\alpha R_1}{R_1 - \alpha} - R_3 \quad \alpha = \frac{V_o' - V_{ref}}{V_{ref}} \cdot R_2$$

Note:

R_t = Trim Resistor value;

α = self-defined parameter;

V_{o'} = desired output voltage (±10% max.)

TRIM resistor connection (dashed line shows internal resistor network)

Vout(VDC)	R1(KΩ)	R2(KΩ)	R3(KΩ)	Vref(V)
3.3	5	3	10	1.24
5	3.036	3	10	2.5
12	11.00	2.87	15	2.5
15	14.03	2.8	15	2.5
24	24.872	2.87	15	2.5
48	53.017	2.913	15	2.5

Note: When using the Trim down function make sure that the R_t resistor value is calculated correctly. If the Trim pin is shorted with +V_o, or its value is too low, then the output voltage V_{o'} would be lower than 0.9V_o, which may cause the product to fail.

Reflected ripple current-test circuit



Note: L_{in}(4.7µH), C_{in}(220µF, ESR < 1.0Ω at 100 KHz)

100QBW4_2.25 series

100W Quarter-Brick - Single Output DC-DC Converter - Ultra-Wide Input - Isolated & Regulated

Mechanical dimensions and recommended layout

THIRD ANGLE PROJECTION 

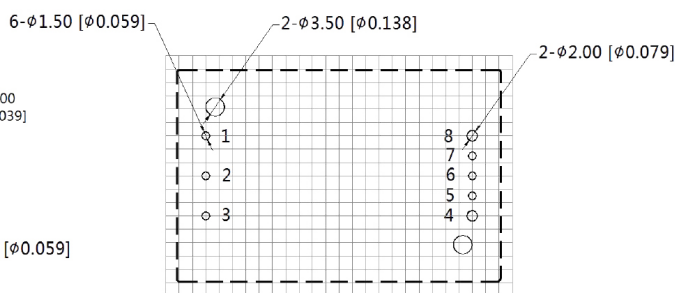
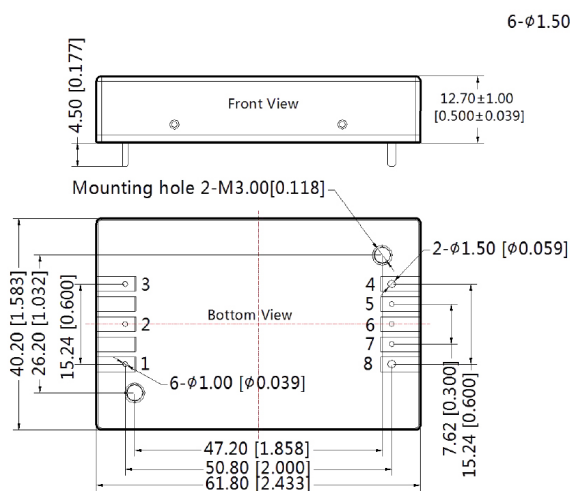

Note: Grid 2.54*2.54mm

Pin-Out			
Pin	Function	Pin	Function
1	+Vin	5	Sense-
2	Ctrl	6	Trim
3	-Vin	7	Sense+
4	0V	8	+Vo

Note:
 Unit: mm[inch]
 Pin1, 2, 3, 5, 6, 7's diameter: 1.00[0.039]
 Pin4, 8's diameter: 1.50[0.059]
 Pin diameter tolerances: ±0.10[±0.004]
 General tolerances: ±0.50[±0.020]
 Mounting hole screwing torque: Max 0.4 N·m

Base plate dimensions and recommended layout (base plate)

THIRD ANGLE PROJECTION 

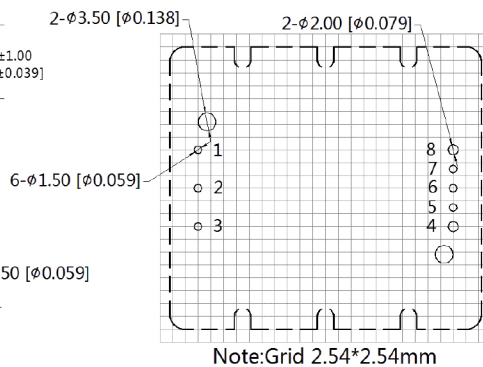
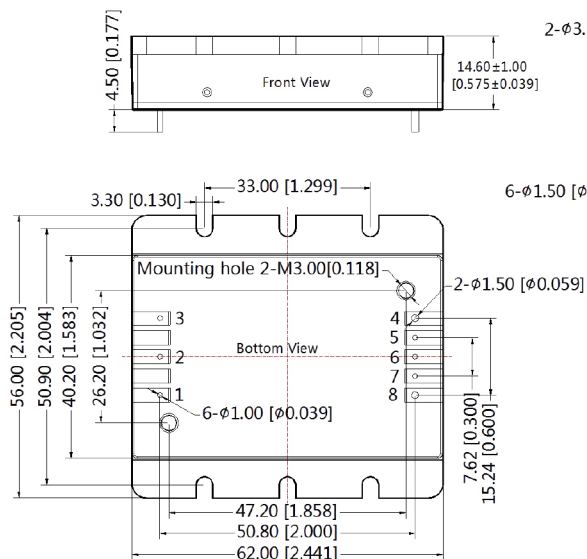

Note: Grid 2.54*2.54mm

Pin-Out			
Pin	Function	Pin	Function
1	+Vin	5	Sense-
2	Ctrl	6	Trim
3	-Vin	7	Sense+
4	0V	8	+Vo

Note:
 Unit: mm[inch]
 Pin1, 2, 3, 5, 6, 7's diameter: 1.00[0.039]
 Pin4, 8's diameter: 1.50[0.059]
 Pin diameter tolerances: ±0.10[±0.004]
 General tolerances: ±0.50[±0.020]
 Mounting hole screwing torque: Max 0.4 N·m

100QBW4_2.25 series

100W Quarter-Brick - Single Output DC-DC Converter - Ultra-Wide Input - Isolated & Regulated

Base-plate dimensions and recommended layout (heatsink)

