

R95-188

Features

- For R51 Series Relays (50 Amp ONLY)
- 5.5 Inch Wire Leads

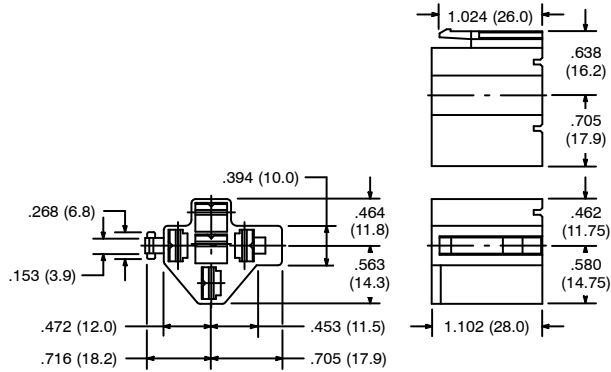

5-Pin Automotive Socket w/Wire Leads

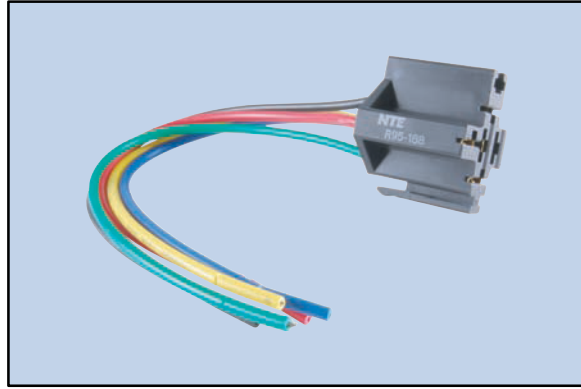

R95-189

Features

- For R51 Series Relays (50 Amp, SPST-NO ONLY)
- 6.5 Inch Wire Leads

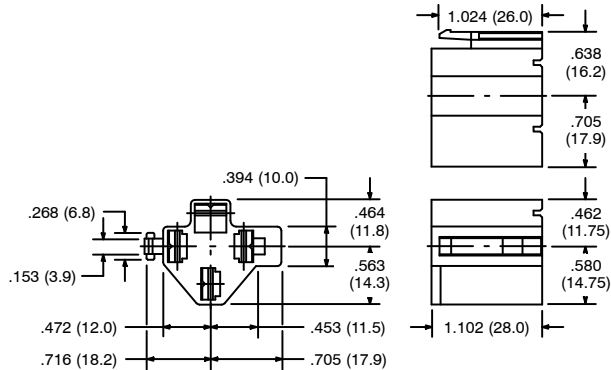

4-Pin Automotive Socket w/Wire Leads

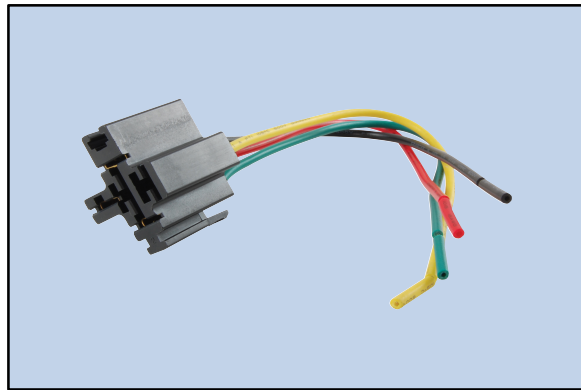

R95-190

Features

- For Weatherproof R51 Series Relays
- 18 AWG Coil and 14 AWG Contacts
- 11 Inch Wire Leads

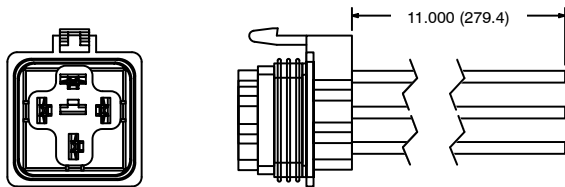

4-Pin Weatherproof Automotive Socket w/Wire Leads

