

NOTE:

- MATERIAL : CLEAR POLYSTYRENE.
- CAMBER NOT TO EXCEED 1MM IN 100MM.
- 10 SPROCKET HOLE PITCH CUMULATIVE TOLERANCE ± 0.2
- Ao AND Bo MEASURED ON A PLANE 0.3MM ABOVE THE BOTTOM OF THE POCKET
- Ko MEASURED FROM A PLANE ON THE INSIDE BOTTOM OF THE POCKET TO THE SURFACE OF THE CARRIER.
- POCKET POSITION RELATIVE TO SPROCKET HOLE MEASURED AS TRUE POSITION OF POCKET, NOT SPROCKET HOLE.

252117TR		REVISIONS			
DRAWING NO.	REV	DESCRIPTION	DATE	ECO	APPR
THIRD ANGLE PROJ.	A	RELEASE TO MFG.	01-Feb-12	--	MG

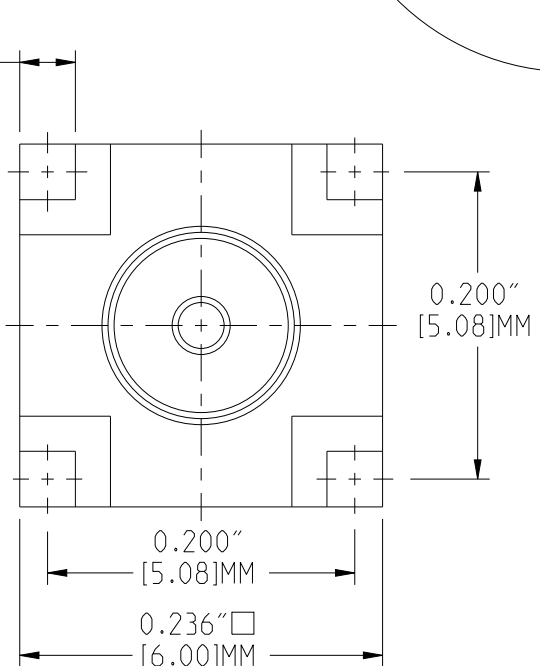
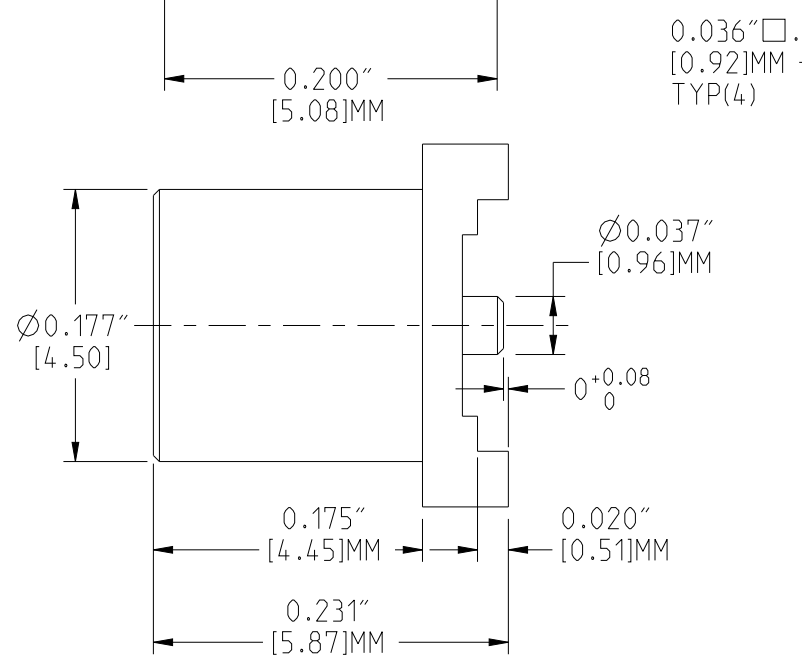
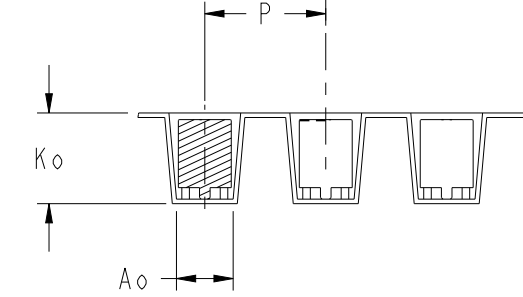
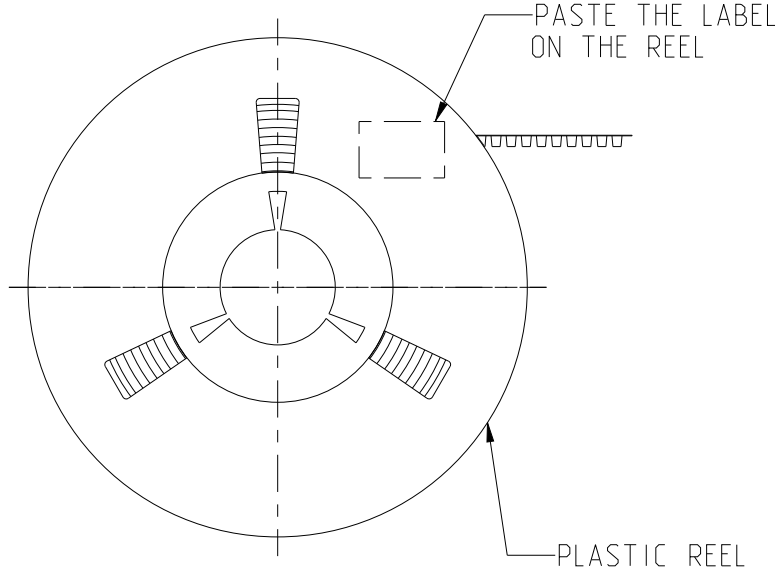
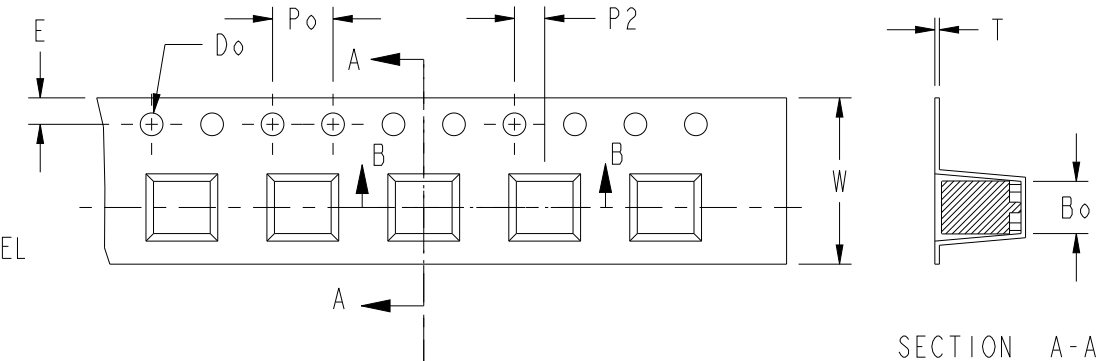
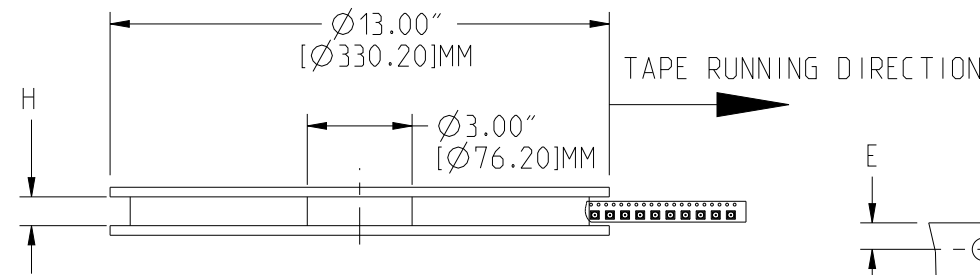
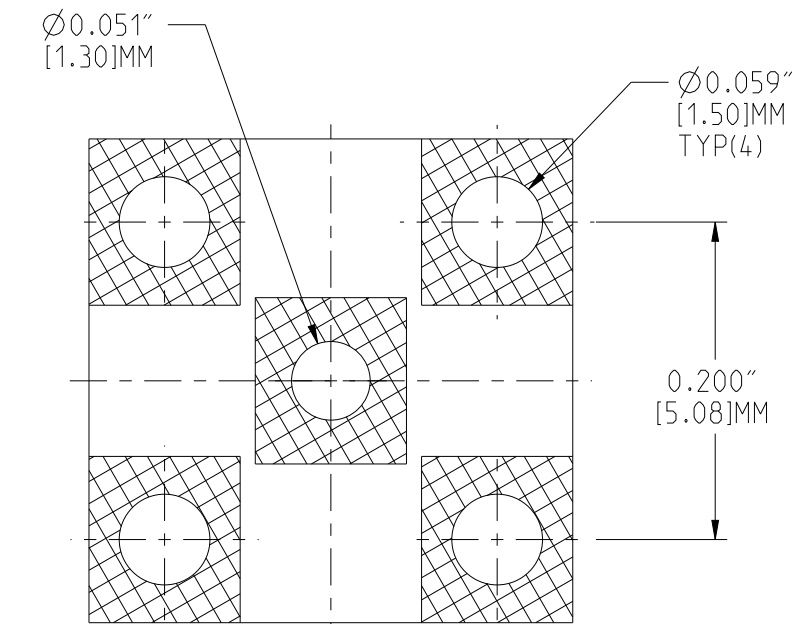

3	CONTACT PIN	BERYLLIUM COPPER	GOLD	1
2	INSULATOR	TEFLON	NATURAL	1
1	BODY	BRASS	GOLD	1
NO	DESCRIPTION	MATERIAL	FINISH	QTY

QTY : 900 PCS/13" REEL					12600 PCS/BOX					
ITEM	W	Ao	Bo	Ko	P	E	Do	Po	P2	T
DIM	16.0±0.30	6.40±0.10	6.40±0.10	6.20±0.10	12.00±0.10	1.75±0.10	1.50±0.10	4.00±0.10	2.00±0.10	0.4±0.05

UNLESS OTHERWISE SPECIFIED, DIMENSIONS ARE IN INCHES AND TOLERANCES ARE: 2 PLACE DECIMAL ±.015 (0,381 mm) 3 PLACE DECIMAL ±.005 (0,127 mm) ANGLES ± 1°	MATERIAL	DRAWN	DATE	TITLE	Amphenol Connex
	TASK - 852	M.GOPI	01-Feb-12		
NOTICE - These drawings, specifications, or other data (1) are, and remain the property of Amphenol Corp. (2) must be returned upon request; and (3) are confidential and not to be disclosed to any person other than those to whom they are given by Amphenol Corp. The furnishing of these drawings, specifications, or other data by Amphenol Corp., or to any other person to anyone for any purpose is not to be regarded by implication or otherwise in any manner licensing, granting rights or permitting such holder or any other person to manufacture, use or sell any product, process or design, patented or otherwise, that may in any way be related to or disclosed by said drawings, specifications, or other data.	REFERENCE	ENGINEER	DATE	SCALE: 8.0:1	SHEET 1 OF 1
		M.GOPI	01-Feb-12		
FINISH	APPROVED	DATE		DWG SIZE	DRAWING NO.
				B	252117TR
					REV A