

# Surface Mount Common Mode Chokes

Suited for LAN and Telecom WAN Applications

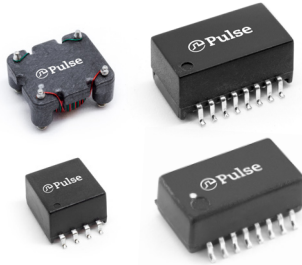

- ⊗ Open MSL1 or moulded MSL4 construction designs available
- ⊗ Reduces radiated EMI emissions and common mode EMC noise
- ⊗ Common mode attenuation from 100 KHz to 1 GHz
- ⊗ Extended Temperature operating range -40 to +85°C
- ⊗ JEDEC - IR Reflow solder peak temperature 245°C
- ⊗ Supplied in Tube or on 13" Tape and Reel

Low Frequency Chokes			Electrical Specifications @ 25°C										DCR (Ω MAX)	Primary Application
Part Number <sup>1</sup>	No. of Lines	Inductance (μH MIN)	Common Mode Attenuation (dB TYP)											
			1 KHz	10 KHz	100 KHz	1 MHz	10 MHz	30 MHz	50 MHz	80 MHz	100 MHz			
PE-65855NL	2	4,700 +/-30%	16	23	41	43	48	39	34	29	26	1.0	WAN / xDSL	
B2013NL	2	9,000 +/-30%	26	43	46	47	43	32	25	24	29	1.0	WAN / xDSL	
BX8333NL	2	16,000 +/-35%	33	36	38	36	22	15	12	10	8	1.65	WAN / xDSL	
BX8333DNL	2	33,000 +/-35%	42	48	46	22	15	12	8	7	6	2.3	WAN / xDSL	

1. For Tape & Reel packaging, add suffix "T" to the end of the part number e.g. B2013NLT  
All Parts conform to JEDEC-J-STD for Moisture Sensitivity Level 1

## MECHANICALS

## SCHEMATICS

### B2013NL

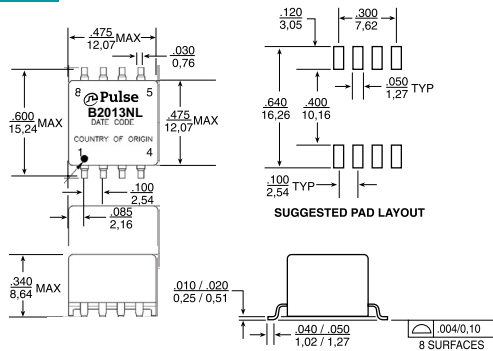

Dimensions: Inches / mm

Unless otherwise specified, all tolerances are ± .010 / 0,25

Weight ..... 1.28 grams  
Tape & Reel .....250/reel  
Tube .....40 pcs

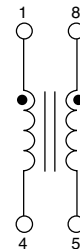

### PE-65855NL, BX8333NL, BX8333DNL

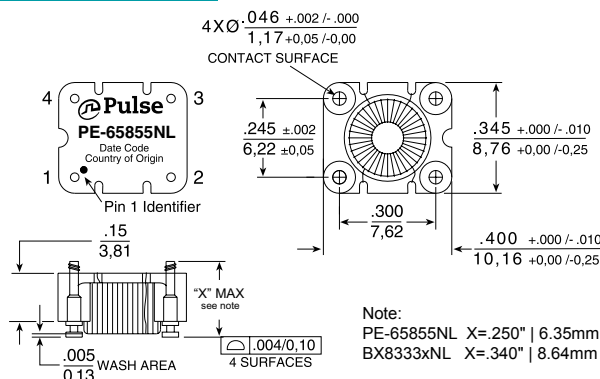

Dimensions: Inches / mm

Unless otherwise specified, all tolerances are ± .010 / 0,25

Weight .....0.74 grams  
Tape & Reel .....450/reel  
Tube .....40 pcs

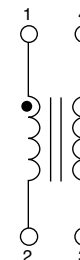

# Surface Mount Common Mode Chokes

Suited for LAN and Telecom WAN Applications



High Frequency Chokes			Electrical Specifications @ 25°C									DCR (Ω MAX)	Primary Application
Part Number <sup>1</sup>	No. of Lines	Inductance (μH MIN)	Common Mode Attenuation (dB TYP)										
			100 KHz	1 MHz	10 MHz	30 MHz	50 MHz	100 MHz	300 MHz	500 MHz	1 GHz		
PE-65857NL	4	22.5	7	20	30	37	38	34	24	13	—	0.22	LAN
T8003NL*	4	33	9	13	32	32	30	27	16	17	13	0.20	WAN
PE-67540NL	4	100	14	33	44	48	49	44	34	29	20	0.60	WAN
Z3Z104SMNL	4	68	8	22	28	28	27	25	20	15	—	0.20	LAN
Z3Z106SMNL	6	68	8	22	29	30	30	29	24	19	—	0.20	LAN
Z3Z105SMNL	8	68	8	24	30	29	27	24	16	11	—	0.20	LAN
PE-69011NL*	8	36	8	24	36	39	35	29	18	11	—	0.35	WAN

1. For Tape & Reel packaging, add suffix "T" to the end of the part number e.g. T8003NLT the exception is Z3Z106SMNL-T  
 \* All Parts conform to JEDEC-J-STD for Moisture Sensitivity Level 1 with the exception of T8003NL and PE-69011NL which are MSL4

## MECHANICALS

## SCHEMATICS

### PE-65857NL, PE-67540NL

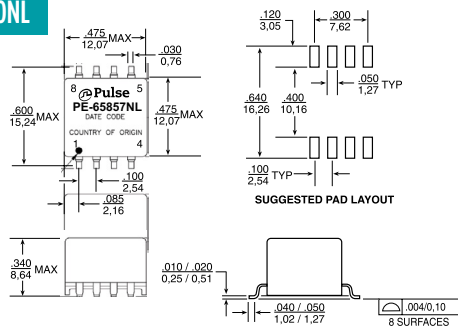

Dimensions:  $\frac{\text{Inches}}{\text{mm}}$

Unless otherwise specified, all tolerances are  $\pm \frac{.010}{0.25}$

Weight ..... 1.28 grams  
 Tape & Reel ..... 250/reel  
 Tube ..... 40 pcs

### PE-65857NL PE-67540NL

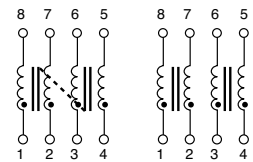

### T8003NL

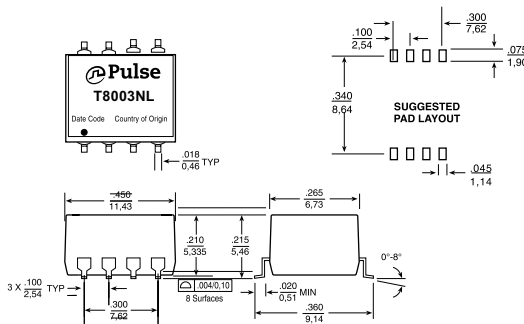

Dimensions:  $\frac{\text{Inches}}{\text{mm}}$

Unless otherwise specified, all tolerances are  $\pm \frac{.010}{0.25}$

Weight ..... 0.89 grams  
 Tape & Reel ..... 750/reel  
 Tube ..... 40 pcs

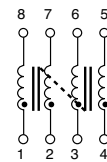

### PE-69011NL

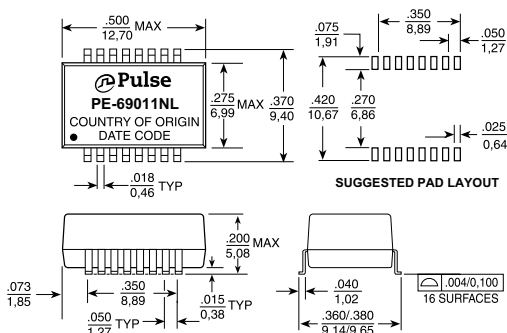

Dimensions:  $\frac{\text{Inches}}{\text{mm}}$

Unless otherwise specified, all tolerances are  $\pm \frac{.010}{0.25}$

Weight ..... 0.89 grams  
 Tape & Reel ..... 850/reel  
 Tube ..... 40 pcs

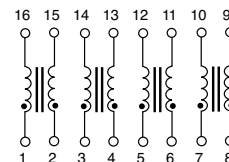

# Surface Mount Common Mode Chokes

Suited for LAN and Telecom WAN Applications

## MECHANICALS

## SCHEMATICS

### 23Z104SMNL

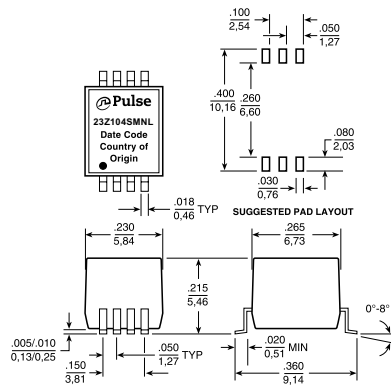

Dimensions:  $\frac{\text{Inches}}{\text{mm}}$

Unless otherwise specified,  
all tolerances are  $\pm \frac{.010}{0.25}$

Weight ..... 0.30 grams

Tape & Reel ..... 750/reel

Tube ..... 85 pcs

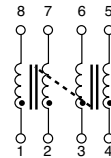

### 23Z105SMNL, 23Z106SMNL

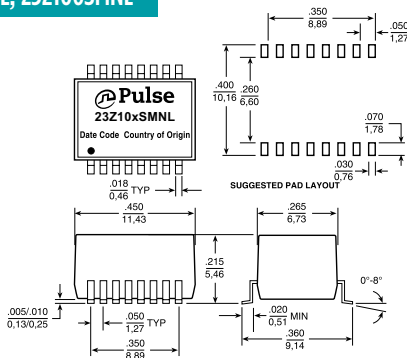

Dimensions:  $\frac{\text{Inches}}{\text{mm}}$

Unless otherwise specified,  
all tolerances are  $\pm \frac{.010}{0.25}$

Weight ..... 0.60 grams

Tape & Reel ..... 750/reel

Tube ..... 40/tray

### 23Z105SMNL

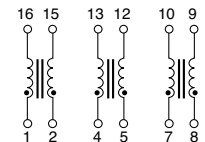
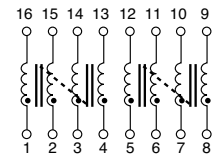

### 23Z106SMNL

## COMMON MODE TEST CIRCUIT FOR SURFACE MOUNT AND THROUGH HOLE

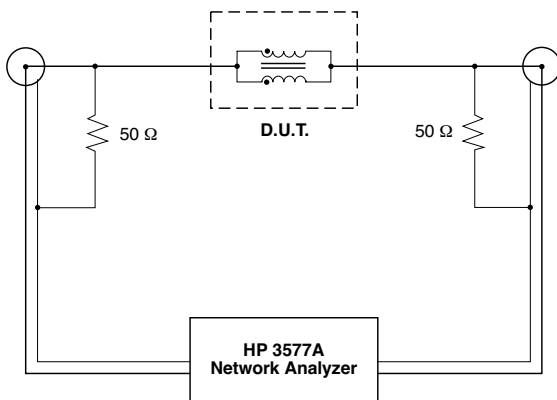

### Test Notes:

1. Network analyzer calibrated to compensate for 50  $\Omega$  resistors.
2. All windings on a core are connected in parallel for the test.
3. For multi-core chokes, test data is for one core only. The windings on the other core(s) are left unconnected (i.e. open).

### For More Information:

Americas - [prodinfinetworkamericas@yageo.com](mailto:prodinfinetworkamericas@yageo.com) | Europe - [prodinfinetworkemea@yageo.com](mailto:prodinfinetworkemea@yageo.com) | Asia - [prodinfinetworkapac@yageo.com](mailto:prodinfinetworkapac@yageo.com)

Performance warranty of products offered on this data sheet is limited to the parameters specified. Data is subject to change without notice. Other brand and product names mentioned herein may be trademarks or registered trademarks of their respective owners. © Copyright, 2023. Pulse Electronics, Inc. All rights reserved.