



Series 222W

6.0 x 6.0mm Tactile Switch

- Surface mount J bend terminal configuration
- Quiet Actuation
- Compatible with IR reflow, and manual soldering
- Variety of operating force options



Ordering Information

Series	Terminal Type	Actuating Direction	Actuation Force	Packaging												
222W	J	V	A	R												
<table border="1"> <thead> <tr> <th>Code</th> <th>Spec.</th> </tr> </thead> <tbody> <tr> <td>J</td> <td>Surface mount J bend</td> </tr> </tbody> </table>		Code	Spec.	J	Surface mount J bend	<table border="1"> <thead> <tr> <th>Code</th> <th>Spec.</th> </tr> </thead> <tbody> <tr> <td>V</td> <td>Vertical</td> </tr> </tbody> </table>		Code	Spec.	V	Vertical	<table border="1"> <thead> <tr> <th>Code</th> <th>Spec.</th> </tr> </thead> <tbody> <tr> <td>R</td> <td>Tape & reel packaging (only available for surface mount type)</td> </tr> </tbody> </table>	Code	Spec.	R	Tape & reel packaging (only available for surface mount type)
Code	Spec.															
J	Surface mount J bend															
Code	Spec.															
V	Vertical															
Code	Spec.															
R	Tape & reel packaging (only available for surface mount type)															
			<table border="1"> <thead> <tr> <th>Code</th> <th>Spec.</th> </tr> </thead> <tbody> <tr> <td>A</td> <td>160 gf, black</td> </tr> <tr> <td>B</td> <td>230 gf, black</td> </tr> </tbody> </table>		Code	Spec.	A	160 gf, black	B	230 gf, black						
Code	Spec.															
A	160 gf, black															
B	230 gf, black															

Electrical Specifications

Parameter	Conditions & Remarks	Min	Max	Unit
Contact Resistance			100	milliohms
Insulation Resistance	Between insulated terminals	100		megohms
Dielectric Strength	250 VAC between adjacent switches		1	minute
Non-switching Rating			50 or 16	mA or VDC

Mechanical and Environmental

Soldering	Maximum reflow temperature, 260°C for 5 seconds Maximum manual temperature, 350°C for 3 seconds
RoHS	Lead-Free. Fully compliant to RoHS Directive 2011/65/EU
Operating Force	160±50 gf 230±50 gf
Actuation Life	100,000 cycles
Actuator Strength	2 Kgf maximum
Travel	1.3±0.2 mm
Packaging	Standard tape and reel packaging
Operating Temperature Range	-40°C to +85°C
Storage Temperature Range	-40°C to +85°C

Soldering Profile

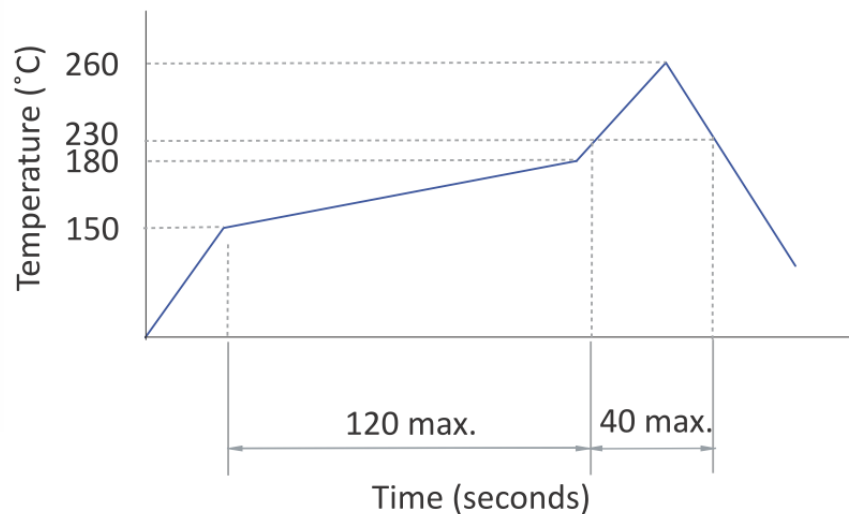

Mechanical Specifications

Figure 1 – 222WJV, Standard Mount J Bend, Vertical Actuation

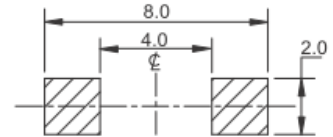
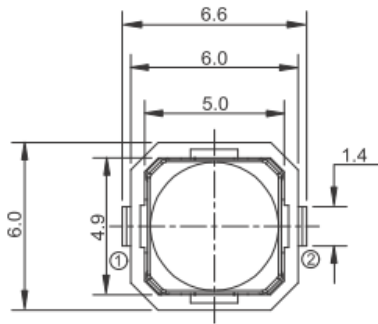

PCB LAYOUT

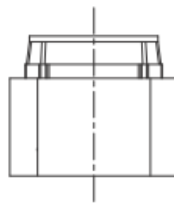
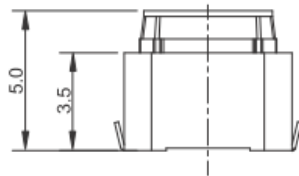

CIRCUIT DIAGRAM

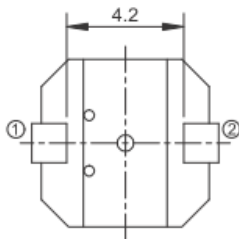

DIMENSION : mm
STANDARD TOLERANCE : ±0.2

Packing: Tape and Reel

Surface Mount J Bend, Actuator Height 5.0mm

The packing specifications:

1. Structure and materials:

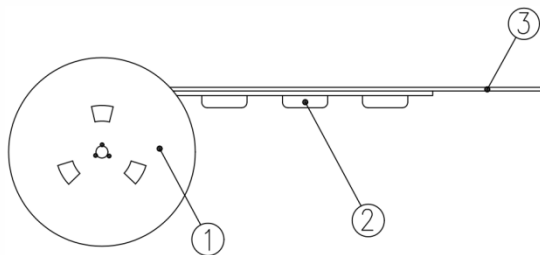

No	PART NAME	MATERIAL
①	REEL	POLYSTYRENE
②	CARRIER TAPE	POLYSTYRENE
③	COVER TAPE	POLYESTER

2. Packing quantity: 1000 pcs/reel
3. More than 15 empty pockets should remain at each end of the carrier tape for each reel.
4. Shortage of less than 10 pcs a reel is acceptable but no more than 3 consecutive empty pockets are allowed.
5. Stripping strength of cover tape is between 10 gf to 130 gf and stripping angle should be within 165°~180°.

6. The product in the pocket of carrier tape should be placed in a specified correct position.
7. Tape and reel per EIA-481.
8. Dimensions:

