

**SERIES: VOF-15C | DESCRIPTION: AC-DC POWER SUPPLY**
**FEATURES**

- universal input (85~264 Vac)
- 2.5 × 1.8 × 0.75 in (63.5 × 45.7 × 19 mm)
- class B EMI performance, meets CISPR32 / EN55032
- output short circuit, overcurrent & overvoltage protection
- designed to meet: IEC/EN/UL 60335 & 62368
- safety certified: IEC/EN/UL 62368

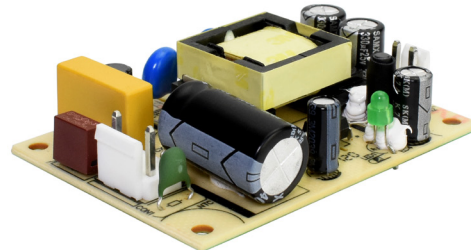

MODEL	output voltage (Vdc)	output current		output power max (W)	ripple and noise <sup>1</sup> max (mVp-p)	efficiency <sup>2</sup> typ (%)
		min (mA)	max (mA)			
VOF-15C-S3	3.3	0	3000	9	100	72
VOF-15C-S5	5	0	2800	14	100	76
VOF-15C-S9	9	0	1600	15	100	78
VOF-15C-S12	12	0	1250	15	100	81
VOF-15C-S15	15	0	1000	15	100	81
VOF-15C-S24	24	0	625	15	100	82

Notes: 1. At full load, nominal input, 20 MHz bandwidth oscilloscope, with 1  $\mu$ F ceramic and 10  $\mu$ F electrolytic capacitors on the output.  
 2. At 230 Vac input.  
 3. All specifications are measured at  $T_a=25^\circ\text{C}$ , humidity <75%, nominal input voltage, and rated output load unless otherwise specified.

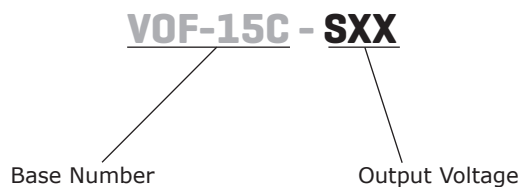
**PART NUMBER KEY**

## INPUT

parameter	conditions/description	min	typ	max	units
voltage		85		264	Vac
		100		370	Vdc
frequency		47		60	Hz
current	at 115 Vac			.37	A
	at 230 Vac			.22	A
inrush current	at 115 Vac		20		A
	at 230 Vac		30		A
no load power consumption				0.5	W

## OUTPUT

parameter	conditions/description	min	typ	max	units
capacitive load	3.3 Vdc output models			20,000	µF
	5 Vdc output models			10,000	µF
	9 Vdc output models			5,800	µF
	12 Vdc output models			5,200	µF
	15 Vdc output models			4,500	µF
	24 Vdc output models			1,000	µF
initial set point accuracy	3.3 Vdc output models		±3		%
	all other models		±2		%
line regulation	at full load		±0.5		%
load regulation	from 0~100% load		±1		%
hold-up time	at 115 Vac, full load		10		ms
	at 230 Vac, full load		60		ms
switching frequency			60		kHz
temperature coefficient			±0.02		%/°C

## PROTECTIONS

parameter	conditions/description	min	typ	max	units
over voltage protection	output voltage clamp, auto recovery				
	3.3, 5 Vdc output models			7.5	Vdc
	9 Vdc output models			15	Vdc
	12, 15 Vdc output models			20	Vdc
	24 Vdc output models			30	Vdc
over current protection	hiccup, auto recovery	130		300	%
short circuit protection	hiccup, continuous, auto-recovery				

## SAFETY & COMPLIANCE

parameter	conditions/description	min	typ	max	units
isolation voltage	input to output electric strength test for 1 minute, leakage current <5 mA	3,000			Vac
safety approvals	IEC/EN/UL 62368-1 certified (designed to meet IEC/EN/UL 60335-1)				
safety class	Class II				
conducted emissions	CISPR32/EN55032, Class B				
radiated emissions	CISPR32/EN55032, Class B				
ESD	IEC/EN61000-4-2, Contact ±6KV, Perf. Criteria B				
radiated immunity	IEC/EN61000-4-3, 10V/m, Perf. Criteria A				

## SAFETY & COMPLIANCE (CONTINUED)

parameter	conditions/description	min	typ	max	units
EFT/burst	IEC/EN61000-4-4, ±2 kV, perf. Criteria B				
surge	IEC/EN61000-4-5, line to line ±1KV, perf. Criteria B				
conducted immunity	IEC/EN61000-4-6, 10 Vrms, Perf. Criteria A				
voltage dips & interruptions	IEC/EN61000-4-11, 0%,70%, perf. Criteria B				
MTBF	as per MIL-HDBK-217F at 25°C	300,000			hours
RoHS	yes				

Notes: 4. The power supply is considered a component which will be installed into final equipment. The final equipment still must be tested to meet the necessary EMC directives.

## ENVIRONMENTAL

parameter	conditions/description	min	typ	max	units
operating temperature	see derating curves	-25		70	°C
storage temperature		-25		85	°C
storage humidity	non-condensing			90	%

## DERATING CURVES

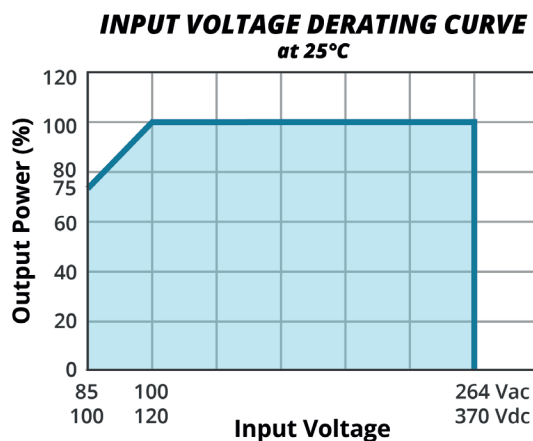
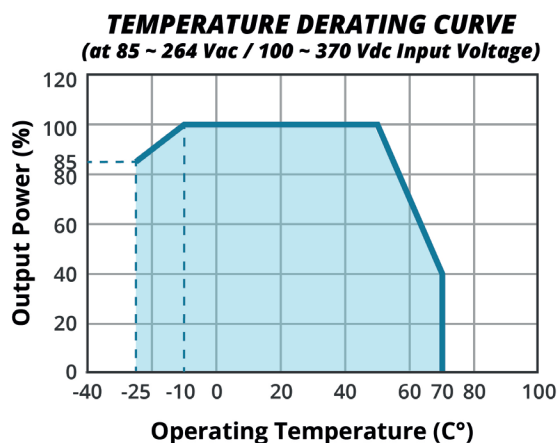

## EFFICIENCY CURVES

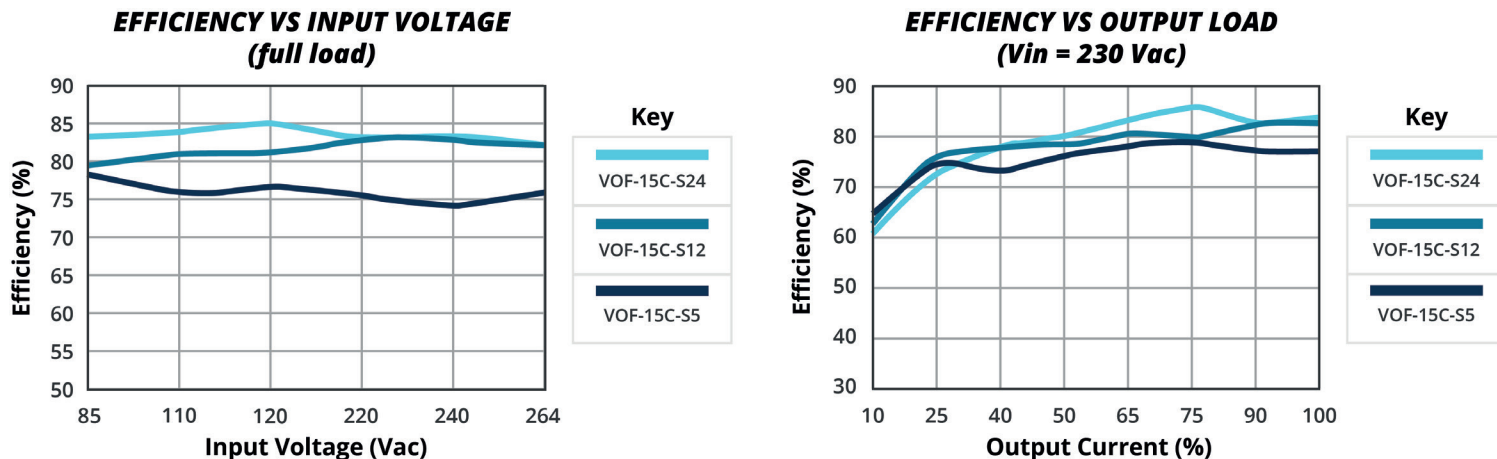

## DESIGN REFERENCE

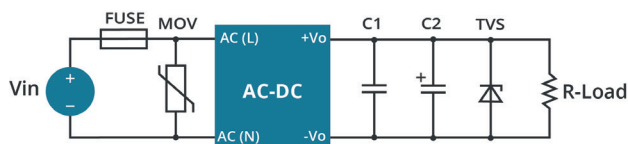

Fig. 1: Typical circuit diagram

Part No.	FUSE	MOV	C1 (μF)	C2 (μF)	TVS
VOF-15C-S3	2A/250V slow-blow	S14K300	0.1	22	SMBJ7.0A
VOF-15C-S5					SMBJ7.0A
VOF-15C-S9					SMBJ12A
VOF-15C-S12					SMBJ20A
VOF-15C-S15					SMBJ20A
VOF-15C-S24					SMBJ30A

### Output Filter Components:

We recommend using an electrolytic capacitor with high frequency, and low ESR rating for C2 (refer to manufacture's datasheet). Choose a Capacitor voltage rating with at least 20% margin, in other words not exceeding 80%. C1 is a ceramic capacitor used for filtering high-frequency noise and TVS is a recommended suppressor diode to protect the application in case of a converter failure.

## MECHANICAL

parameter	conditions/description	min	typ	max	units
dimensions	63.50 x 45.70 x 19.00				mm
weight			36		g

## MECHANICAL DRAWING (BOARD MOUNT)

units: mm[inch]

tolerance:  $\pm 0.50[\pm 0.020]$

Mounting hole screwing torque: Max 0.4 N·m

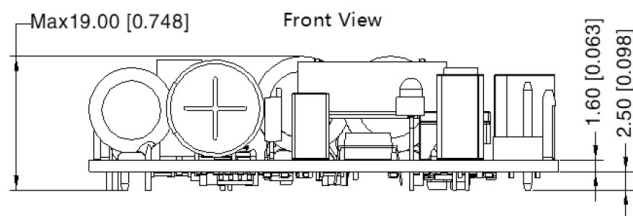
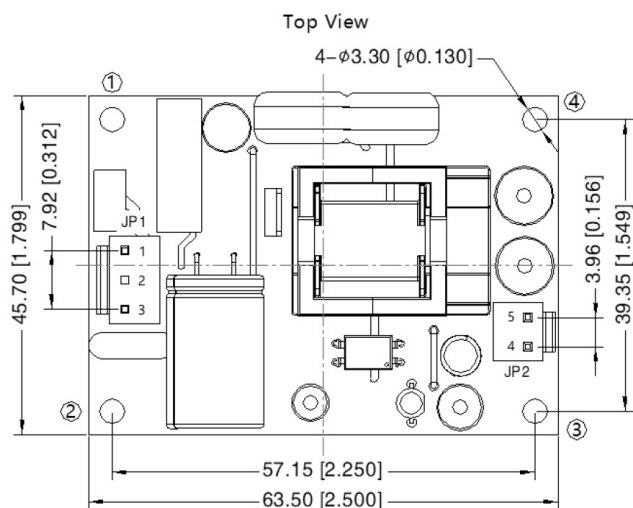

PIN-Out			
Connector	PIN	Function	Connector
JP1	1	AC(L)	Housing: JST VHR Contact: JSTSVH-21T-P1.1 or equivalent
	2	NoPin	
	3	AC(N)	
JP2	4	-Vo	Housing: JST VHR Contact: JSTSVH-21T-P1.1 or equivalent
	5	+Vo	

Position	Screw Spec.	L (Recommended)	Torque (max)
①~④	M3	6 mm	0.4N·m

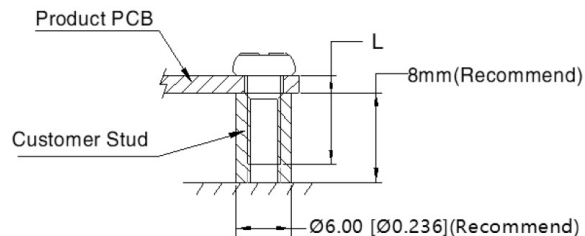

## REVISION HISTORY

rev.	description	date
1.0	initial release	10/24/2019
1.01	company logo updated	12/03/2020
1.02	derating and efficiency curves and circuit diagram updated	02/14/2022
1.03	product image updated	03/21/2022
1.04	UKCA mark added	06/06/2022
1.05	mechanical drawing updated	01/10/2023

The revision history provided is for informational purposes only and is believed to be accurate.



**CUI INC**  
a bel group

**Headquarters**  
20050 SW 112th Ave.  
Tualatin, OR 97062  
**800.275.4899**

Fax 503.612.2383  
**cui.com**  
techsupport@cui.com

CUI offers a two (2) year limited warranty. Complete warranty information is listed on our website.

CUI reserves the right to make changes to the product at any time without notice. Information provided by CUI is believed to be accurate and reliable. However, no responsibility is assumed by CUI for its use, nor for any infringements of patents or other rights of third parties which may result from its use.

CUI products are not authorized or warranted for use as critical components in equipment that requires an extremely high level of reliability. A critical component is any component of a life support device or system whose failure to perform can be reasonably expected to cause the failure of the life support device or system, or to affect its safety or effectiveness.