

SERIES: VGS-150B | DESCRIPTION: AC-DC POWER SUPPLY**FEATURES**

- +70°C operation
- output trim
- current/voltage/temperature protections
- screw terminal interface
- switch-selectable AC input range
- low standby power consumption
- 30 mm height



MODEL	output voltage	output current	output power	ripple and noise ¹	efficiency ²
	(Vdc)	max (A)	max (W)	max (mVp-p)	typ (%)
VGS-150B-12	12	12.5	150	100	86
VGS-150B-24	24	6.5	156	100	88
VGS-150B-48	48	3.2	153.6	200	88

Notes: 1. 20 MHz bandwidth oscilloscope, 12" of twisted load cables paralleled with 0.1 μ F ceramic and 47 μ F electrolytic capacitors placed across the terminals at the load.
 2. At 230 Vac, 50 Hz, full load.
 3. All specifications are measured at $T_a=25^\circ\text{C}$, nominal input voltage, and rated output load unless otherwise specified.

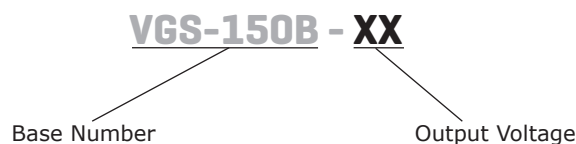
PART NUMBER KEY

INPUT

parameter	conditions/description	min	typ	max	units
voltage	via input selector switch ¹	88	115	132	Vac
		176	230	264	Vac
frequency		47		63	Hz
current	at 115 Vac, full load			3.0	A
	at 230 Vac, full load			1.7	A
inrush current	at 230 Vac, cold start, full load			40	A
leakage current				3.5	mA
no load power consumption	at 230 Vac			0.5	W

Notes: 1. Input selector must be set to match input voltage or damage could occur.

OUTPUT

parameter	conditions/description	min	typ	max	units
line regulation	48 Vdc output model			±0.5	%
	all other models			±1	%
load regulation	12 Vdc output model			±2	%
	24 Vdc output model			±1	%
	48 Vdc output model			±0.5	%
adjustability	built in trim pot		±10		%
start-up time	at 115/230 Vac, full load			0.5	s
rise time	at 115/230 Vac, full load			80	ms
hold-up time	at 115/230 Vac, full load	20			ms
switching frequency			65		kHz

PROTECTIONS

parameter	conditions/description	min	typ	max	units
over voltage protection	output shutdown, must recycle power to recover	110		150	%
over current protection	output shutdown, auto recovery	110		150	%
short circuit protection	output shutdown, auto recovery				

SAFETY & COMPLIANCE

parameter	conditions/description	min	typ	max	units
isolation voltage	input to output for 1 minute, 10 mA		1,500		Vac
	input to ground for 1 minute, 10 mA		1,500		Vac
	output to ground for 1 minute, 10 mA		500		Vac
isolation resistance	input to output at 500 Vdc	100			MΩ
	input to ground at 500 Vdc	100			MΩ
	output to ground 500 Vdc	100			MΩ
safety approvals	certified to 62368: EN certified to 60950: IEC/UL				
safety class	class I				
conducted emissions	EN 55032:2015, Class B				
radiated emissions	EN 55032:2015, Class B				
input current harmonics	EN 61000-3-2:2014, Class A				
voltage fluctuation and flicker	EN 61000-3-3:2013, Class A				
ESD immunity	IEC 61000-4-2, air: ±8 kV; contact: ±4 kV, Class A				
radiated field immunity	IEC 61000-4-3, 3 V/m, Class A				
electrical fast transient immunity	IEC 61000-4-4, Ac power port: 1 kV; signal & telecommunication ports: 0.5 kV, Class B				

Notes: 2. The power supply is considered a component which will be installed into final equipment. The final equipment still must be tested to meet the necessary EMC directives.

SAFETY & COMPLIANCE (CONTINUED)

parameter	conditions/description	min	typ	max	units
surge immunity	IEC 61000-4-5, input L to input N: 1 kV; input L to FG: 2 kV; input N to FG: 2 kV, Class C				
conducted immunity	IEC 61000-4-6, frequency range: 0.15~80 MHz; field strength: 3 Vms, Class A				
magnetic field immunity	IEC 61000-4-8, 1 A/m, Class A				
voltage dips, interruptions	IEC 61000-4-11: voltage dips >95% reduction, 0.5 period, Class A voltage dips 30% reduction, 25 period, Class B voltage dips >95% reduction, 250 period, Class C				
MTBF	as per MIL-HDBK-217F, 25°C		200,000		hours
RoHS	yes				

Notes: 1. The power supply is considered a component which will be installed into final equipment. The final equipment still must be tested to meet the necessary EMC directives.

ENVIRONMENTAL

parameter	conditions/description	min	typ	max	units
operating temperature	see derating curves	-20		70	°C
storage temperature		-40		85	°C
operating humidity	non-condensing	20		90	%
storage humidity	non-condensing	10		95	%

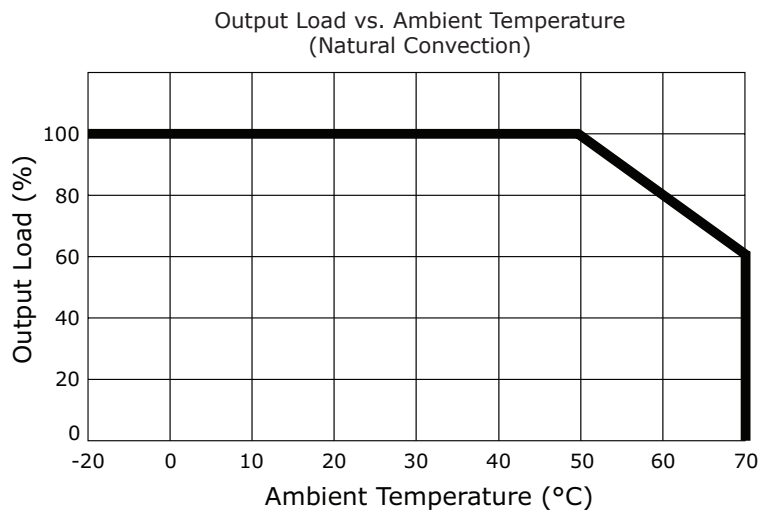
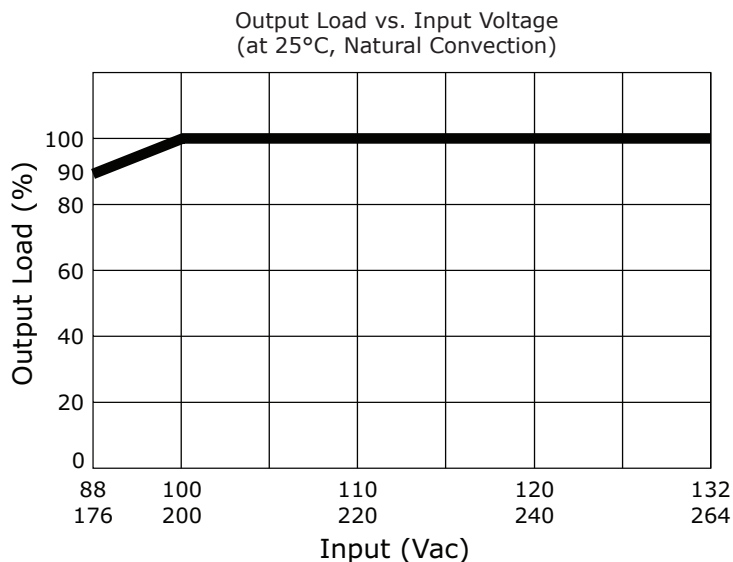
DERATING CURVES

MECHANICAL

parameter	conditions/description	min	typ	max	units
dimensions	159 x 97 x 30				mm
weight			500		g
cooling	natural convection				
input/output connector	screw terminals accept 22~12 AWG wire, 1.2 N-m torque				

MECHANICAL DRAWING

units: mm
tolerance: ±0.3 mm

Input/Output Connector	
PIN	Function
1	AC(L)
2	AC(N)
3	FG
4	-V
5	-V
6	+V
7	+V

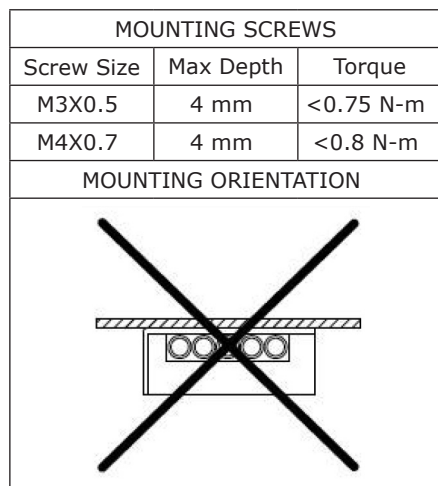
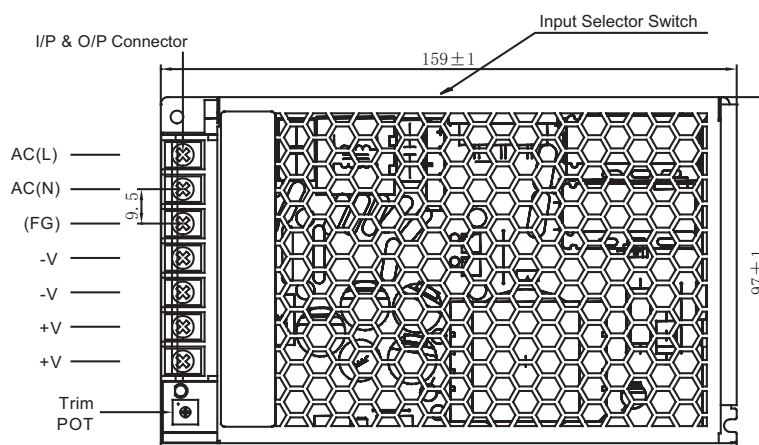

Note: 1. Parts should not be mounted in an upside down orientation.

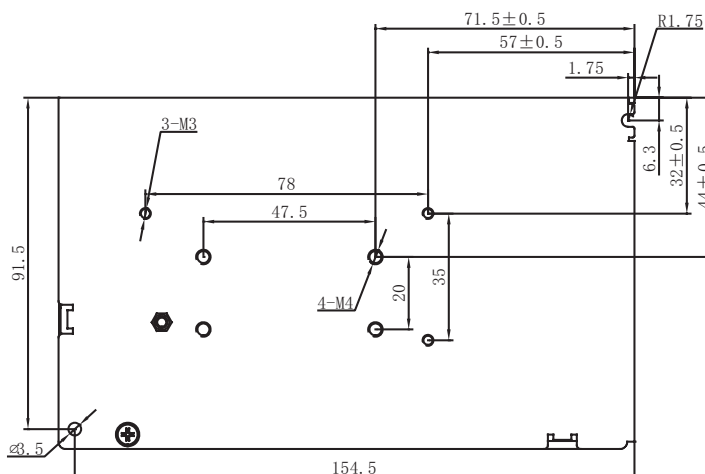
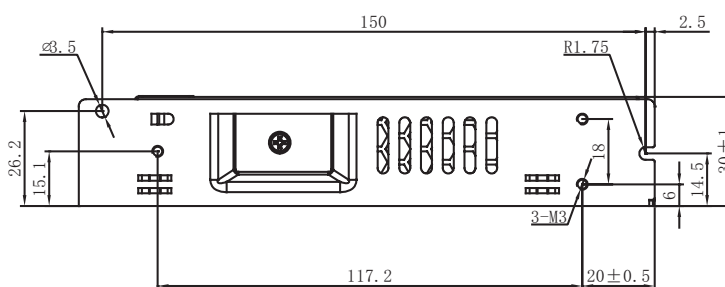

REVISION HISTORY

rev.	description	date
1.0	initial release	06/20/2018
1.01	company logo updated	12/22/2020
1.02	safeties updated	01/25/2021

The revision history provided is for informational purposes only and is believed to be accurate.



CUI INC
a bel group

Headquarters
20050 SW 112th Ave.
Tualatin, OR 97062
800.275.4899

Fax 503.612.2383
cui.com
techsupport@cui.com

CUI offers a two (2) year limited warranty. Complete warranty information is listed on our website.

CUI reserves the right to make changes to the product at any time without notice. Information provided by CUI is believed to be accurate and reliable. However, no responsibility is assumed by CUI for its use, nor for any infringements of patents or other rights of third parties which may result from its use.

CUI products are not authorized or warranted for use as critical components in equipment that requires an extremely high level of reliability. A critical component is any component of a life support device or system whose failure to perform can be reasonably expected to cause the failure of the life support device or system, or to affect its safety or effectiveness.