

Features:

- Chip size from 0201 to 2512
- Max. resistance value less than 3 milliohm for 0201 and 0402, less than 0.5 milliohm for all other sizes
- Qualified to AEC-Q200
- 100% RoHS compliant and lead free without exemption
- Halogen free
- REACH compliant



Applications:

- Switching power supply
- Voltage regulation module
- DC-DC converter, adaptor, battery pack, charger
- PDA and cell phone
- Power and battery management applications

Electrical Specifications					
Type/Code	Power Rating (W) @ 70°C	Current Rating (A)	Max Overload Current (A)	Operating Temperature Range	Maximum Resistance Value (Ω)
HCJ0201	0.1	5.8	14.5	-55°C to +155°C	≤ 0.003
HCJ0402	0.125	6.5	16.2		≤ 0.003
HCJ0603	0.25	22.4	56.0		≤ 0.0005
HCJ0805	0.5	31.6	79.0		≤ 0.0005
HCJ1206	0.75	38.7	96.7		≤ 0.0005
HCJ2010	1	70.7	112.0		≤ 0.0002
HCJ2512	2	63.2	158.0		≤ 0.0005

Power rating: $P=I^2 \cdot R$

Mechanical Specifications					

Type/Code	L	W	H	a	Unit
HCJ0201	0.024 ± 0.001	0.012 ± 0.001	0.010 ± 0.002	0.006 ± 0.002	inches
	0.60 ± 0.03	0.30 ± 0.03	0.26 ± 0.05	0.15 ± 0.05	mm
HCJ0402	0.039 ± 0.004	0.020 ± 0.002	0.016 ± 0.002	0.012 ± 0.004	inches
	1.00 ± 0.10	0.50 ± 0.05	0.40 ± 0.05	0.30 ± 0.10	mm
HCJ0603	0.063 ± 0.010	0.031 ± 0.010	0.020 ± 0.008	0.016 ± 0.008	inches
	1.60 ± 0.25	0.80 ± 0.25	0.50 ± 0.20	0.40 ± 0.20	mm
HCJ0805	0.079 ± 0.010	0.047 ± 0.010	0.026 ± 0.008	0.022 ± 0.008	inches
	2.00 ± 0.25	1.20 ± 0.25	0.65 ± 0.20	0.55 ± 0.20	mm
HCJ1206	0.126 ± 0.010	0.063 ± 0.010	0.026 ± 0.008	0.031 ± 0.008	inches
	3.20 ± 0.25	1.60 ± 0.25	0.65 ± 0.20	0.80 ± 0.20	mm
HCJ2010	0.200 ± 0.010	0.100 ± 0.010	0.026 ± 0.008	0.083 ± 0.012	inches
	5.08 ± 0.25	2.54 ± 0.25	0.65 ± 0.20	2.10 ± 0.30	mm
HCJ2512	0.252 ± 0.012	0.126 ± 0.012	0.026 ± 0.008	0.037 ± 0.014	inches
	6.40 ± 0.30	3.20 ± 0.30	0.65 ± 0.20	0.95 ± 0.35	mm

Note: Size 0201 has no marking.

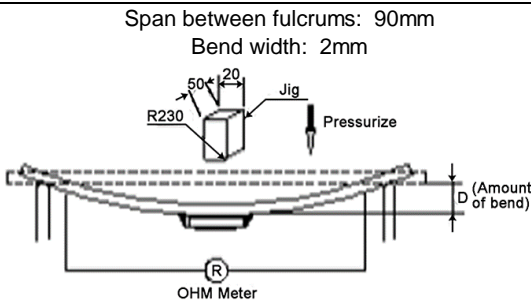
Performance Characteristics (per JIS-C 5201)		
Test	Test Condition	Test Specification
Short Time Overload	2.5 times rated current for 5 seconds, for all sizes except 2010. For 2010 size, 2.5 times rated power for 5 seconds.	For size 0402, max. 0.003 Ω All other sizes, max. 0.0005 Ω
High Temperature Exposure	1000 hours at 155°C ± 2°C	
Low Temperature Storage	1000 hours at -55°C ± 2°C	
Resistance to Solder Heat	The part shall be immersed into the flux specified in the solder bath 260°C ± 5°C for 10 ± 1 seconds	
Moisture Load Life	Specimens shall be placed in a chamber and subject to a relative humidity of 90~95% and to a temperature of 40°C ± 2°C. Load with rated current 1.5 hours "ON", 0.5 hours "OFF", for the period of 1000 hours.	
Temperature cycling	-55°C to +155°C, 100 cycles	
Load Life	Apply rated power at 70°C ± 2°C for 1000 hours with 1.5 hours "ON" and 0.5 hour "OFF"	
Mechanical Shock	a = 50 G, t = 11 ms, 5 times shock	
Substrate Bending	Span between fulcrums: 90mm Bend width: 2mm 	
Solderability	245°C ± 5°C for 3 ± 0.5 seconds	

Operating temperature range is -55°C to 155°C

Power Derating Curve:

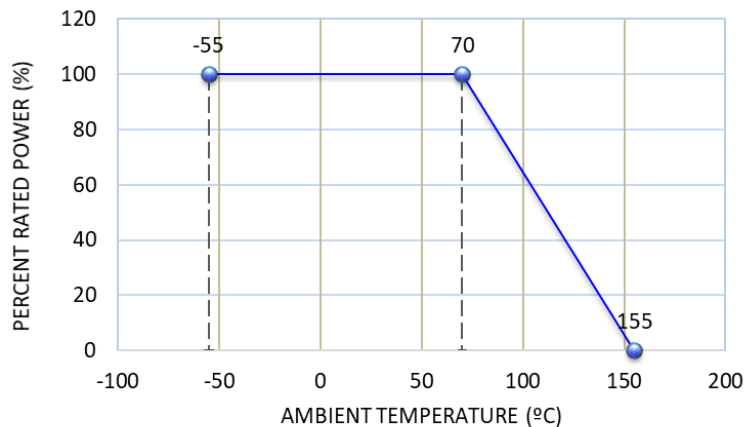

Recommended Pad Layout

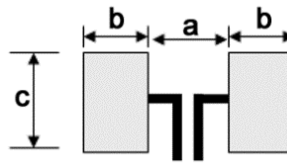

Type/Code	a	b	c	Unit
HCJ0201	0.010	0.012	0.014	inches
	0.25	0.30	0.35	mm
HCJ0402	0.016	0.020	0.024	inches
	0.40	0.50	0.60	mm
HCJ0603	0.024	0.051	0.036	inches
	0.60	1.30	0.92	mm
HCJ0805	0.031	0.055	0.057	inches
	0.80	1.40	1.44	mm
HCJ1206	0.047	0.071	0.072	inches
	1.20	1.80	1.84	mm
HCJ2010	0.028	0.144	0.113	inches
	0.70	3.65	2.88	mm
HCJ2512	0.150	0.083	0.134	inches
	3.80	2.10	3.40	mm

Wave Solder Temperature Condition

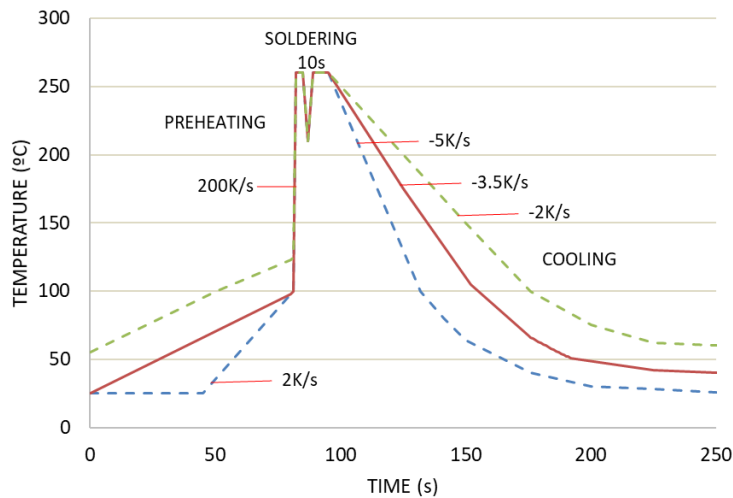

Preheating	100°C ~ 130°C, max. 100 seconds
Soldering	250°C ~ 265°C, max. 10 seconds
Maximum Temperature	260°C ± 5°C, max. 10 seconds

Solder Reflow Temperature Condition

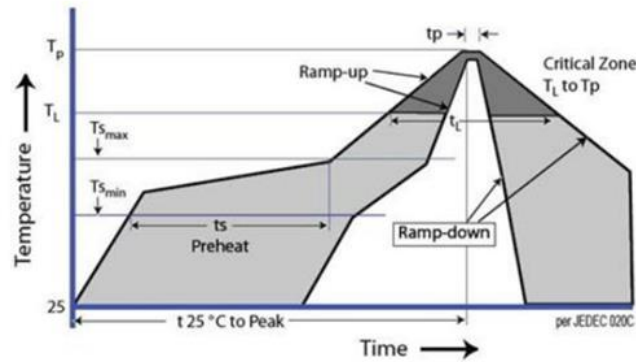

Profile Feature	Pb-Free Assembly
Average Ramp-up Rate ($T_{s_{max}}$ to T_p)	3°C / second max.
Preheat	
- Temperature Min ($T_{s_{min}}$)	150°C
- Temperature Max ($T_{s_{max}}$)	200°C
- Time ($t_{s_{min}}$ to $t_{s_{max}}$)	60 - 180 seconds
Time maintained	
- Temperature (T_L)	217°C
- Time (t_L)	60 - 150 seconds
Peak Temperature (T_p)	260 + 0°C
Time within 5°C of actual peak	
Temperature (t_p)	20 - 40 seconds
Ramp-Down Rate	6°C / second max.
Time 25°C to Peak Temperature	8 minutes max.

Packaging Specifications

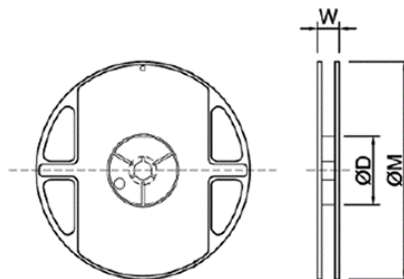

Type/Code	ØD	W	ØM	Unit
All sizes except 2010 and 2512	2.362 ± 0.079	0.354 ± 0.039	7.008 ± 0.197	inches
	60.00 ± 2.00	9.00 ± 1.00	178.00 ± 5.00	mm
HCJ2010 and HCJ2512	2.362 ± 0.079	0.512 ± 0.039	7.008 ± 0.197	inches
	60.00 ± 2.00	13.00 ± 1.00	178.00 ± 5.00	mm

Taping Specifications – Paper Tape

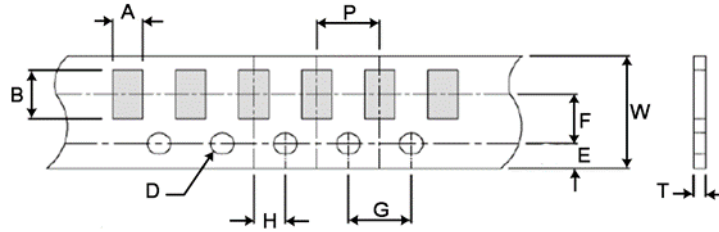

Type/Code	A	B	E	F	W	Unit
HCJ0201	0.018 ± 0.004 0.45 ± 0.10	0.030 ± 0.004 0.75 ± 0.10	0.069 ± 0.004 1.75 ± 0.10	0.138 ± 0.002 3.50 ± 0.05	0.315 ± 0.008 8.00 ± 0.20	inches mm
HCJ0402	0.028 ± 0.002 0.70 ± 0.05	0.047 ± 0.002 1.20 ± 0.05	0.069 ± 0.004 1.75 ± 0.10	0.138 ± 0.002 3.50 ± 0.05	0.315 ± 0.008 8.00 ± 0.20	inches mm
HCJ0603	0.046 ± 0.008 1.18 ± 0.20	0.078 ± 0.008 1.98 ± 0.20	0.069 ± 0.004 1.75 ± 0.10	0.138 ± 0.004 3.50 ± 0.10	0.315 ± 0.012 8.00 ± 0.30	inches mm
HCJ0805	0.066 ± 0.008 1.68 ± 0.20	0.094 ± 0.008 2.38 ± 0.20	0.069 ± 0.004 1.75 ± 0.10	0.138 ± 0.004 3.50 ± 0.10	0.315 ± 0.012 8.00 ± 0.30	inches mm
HCJ1206	0.081 ± 0.008 2.05 ± 0.20	0.144 ± 0.008 3.65 ± 0.20	0.069 ± 0.004 1.75 ± 0.10	0.138 ± 0.004 3.50 ± 0.10	0.315 ± 0.012 8.00 ± 0.30	inches mm
Type/Code	G	P	H	D	T	Unit
HCJ0201	0.157 ± 0.004 4.00 ± 0.10	0.157 ± 0.004 4.00 ± 0.10	0.079 ± 0.004 2.00 ± 0.10	0.059 +0.004/-0.00 1.50 +0.10/-0.00	0.014 ± 0.004 0.35 ± 0.10	inches mm
HCJ0402	0.157 ± 0.004 4.00 ± 0.10	0.079 ± 0.004 2.00 ± 0.10	0.079 ± 0.004 2.00 ± 0.10	0.059 +0.004/-0.00 1.50 +0.10/-0.00	0.018 ± 0.004 0.45 ± 0.10	inches mm
HCJ0603	0.157 ± 0.004 4.00 ± 0.10	0.157 ± 0.004 4.00 ± 0.10	0.079 ± 0.004 2.00 ± 0.10	0.059 +0.004/-0.00 1.50 +0.10/-0.00	0.030 ± 0.008 0.75 ± 0.20	inches mm
HCJ0805	0.157 ± 0.004 4.00 ± 0.10	0.157 ± 0.004 4.00 ± 0.10	0.079 ± 0.004 2.00 ± 0.10	0.059 +0.004/-0.00 1.50 +0.10/-0.00	0.034 ± 0.008 0.87 ± 0.20	inches mm
HCJ1206	0.157 ± 0.004 4.00 ± 0.10	0.157 ± 0.004 4.00 ± 0.10	0.079 ± 0.004 2.00 ± 0.10	0.059 +0.004/-0.00 1.50 +0.10/-0.00	0.034 ± 0.008 0.87 ± 0.20	inches mm

Taping Specifications – Embossed Plastic Tape

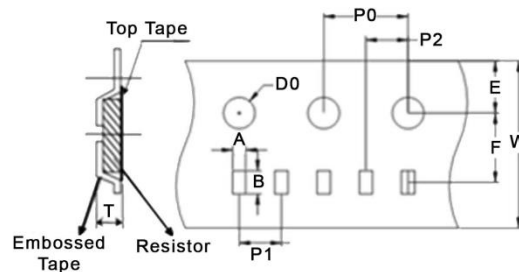

Type/Code	A	B	E	F	W	Unit
HCJ2010	0.112 ± 0.008 2.85 ± 0.20	0.215 ± 0.008 5.45 ± 0.20	0.069 ± 0.004 1.75 ± 0.10	0.217 ± 0.002 5.50 ± 0.05	0.472 ± 0.012 12.00 ± 0.30	inches mm
HCJ2512	0.134 ± 0.008 3.40 ± 0.20	0.266 ± 0.008 6.75 ± 0.20	0.069 ± 0.004 1.75 ± 0.10	0.217 ± 0.002 5.50 ± 0.05	0.472 ± 0.012 12.00 ± 0.30	inches mm
Type/Code	P0	P1	P2	D0	T	Unit
HCJ2010	0.157 ± 0.004 4.00 ± 0.10	0.157 ± 0.004 4.00 ± 0.10	0.079 ± 0.004 2.00 ± 0.10	0.059 +0.004/-0.00 1.50 +0.10/-0.00	0.031 ± 0.008 0.80 ± 0.20	inches mm
HCJ2512	0.157 ± 0.004 4.00 ± 0.10	0.157 ± 0.004 4.00 ± 0.10	0.079 ± 0.004 2.00 ± 0.10	0.059 +0.004/-0.00 1.50 +0.10/-0.00	0.031 ± 0.008 0.80 ± 0.20	inches mm

RoHS Compliance

Stackpole Electronics has joined the worldwide effort to reduce the amount of lead in electronic components and to meet the various regulatory requirements now prevalent, such as the European Union’s directive regarding “Restrictions on Hazardous Substances” (RoHS 3). As part of this ongoing program, we periodically update this document with the status regarding the availability of our compliant components. All our standard part numbers are compliant to EU Directive 2011/65/EU of the European Parliament as amended by Directive (EU) 2015/863/EU as regards the list of restricted substances.

RoHS Compliance Status						
Standard Product Series	Description	Package / Termination Type	Standard Series RoHS Compliant	Lead-Free Termination Composition	Lead-Free Mfg. Effective Date (Std Product Series)	Lead-Free Effective Date Code (YY/WW)
HCJ	Molded Metal Plate Sensing Resistor	SMD	YES	100% Matte Sn over Ni	Always	Always

“Conflict Metals” Commitment

We at Stackpole Electronics, Inc. are joined with our industry in opposing the use of metals mined in the “conflict region” of the eastern Democratic Republic of the Congo (DRC) in our products. Recognizing that the supply chain for metals used in the electronics industry is very complex, we work closely with our own suppliers to verify to the extent possible that the materials and products we supply do not contain metals sourced from this conflict region. As such, we are in compliance with the requirements of Dodd-Frank Act regarding Conflict Minerals.

Compliance to “REACH”

We certify that all passive components supplied by Stackpole Electronics, Inc. are SVHC (Substances of Very High Concern) free and compliant with the requirements of EU Directive 1907/2006/EC, “The Registration, Evaluation, Authorization and Restriction of Chemicals”, otherwise referred to as REACH. Contact us for complete list of REACH Substance Candidate List.

Environmental Policy

It is the policy of Stackpole Electronics, Inc. (SEI) to protect the environment in all localities in which we operate. We continually strive to improve our effect on the environment. We observe all applicable laws and regulations regarding the protection of our environment and all requests related to the environment to which we have agreed. We are committed to the prevention of all forms of pollution.

How to Order

