



PRODUCT SELECTION GUIDE

2023



GD32 MCU

arm CORTEX

arm Community

arm University Program

RISC-V

中国开放指令生态 (RISC-V) 联盟
China RISC-V Alliance

中国RISC-V产业联盟
China RISC-V Industry Consortium

ABOUT US

GigaDevice Semiconductor Inc. (SSE Stock Code 603986) is a global leading fabless supplier. The company was founded in April 2005 and headquartered in Beijing, China, with branch offices in many countries and regions worldwide, providing local support at customers' fingertips.

Committed to building a complete ecosystem with major product lines—Flash memory, MCU, sensor and power as the core driving force, GigaDevice can provide a wide range of solutions and services in the fields of industrial, automotive, computing, consumer electronics, IoT, mobile, networking and communications. GigaDevice is currently ranked No. 1 NOR FLASH® supplier in China and No. 3 in the world with accumulated shipments over 19 billion since its inception. GigaDevice GD32 MCU is a leader in China's high performance 32-bit general-purpose microcontroller market, with more than 1 billion units shipped, and over 450 part numbers from 38 family series in a variety of applications. In addition, GigaDevice delivers touchscreen controller sensor and fingerprint sensor to world-renowned mobile makers around the globe. It is currently one of the only two optical fingerprint sensor suppliers in China with mass production capability. GigaDevice's touchscreen controller sensor is ranked No. 4, and the optical fingerprint sensor is ranked No. 3 in the world.

GigaDevice management system has achieved ISO9001, ISO14001 and Duns certified. Constantly looking to expand the technology offering to customers, GigaDevice has also formed multiple strategic alliances with leading foundries, assembly, and test plants to streamline supply chain management. For more details, please visit: www.gigadevice.com

Contents



GD32 MCU Product Family

Performance	Arm® Cortex®-M 32-bit MCUs				RISC-V 32-bit MCUs	
	Cortex®-M23	Cortex®-M3	Cortex®-M4		Cortex®-M33	
High-Performance		GD32F207 120MHz, 3M/256K GD32F205 120MHz, 3M/256K	GD32F470 240MHz, 3M/768K GD32F427 200MHz, 3M/256K GD32F425 200MHz, 3M/256K	GD32F450 200MHz, 3M/512K GD32F407 168MHz, 3M/192K GD32F405 168MHz, 3M/192K GD32F403 168MHz, 3M/128K	GD32W515 180MHz, 2048K/448K GD32E508 180MHz, 512K/128K GD32E507 180MHz, 512K/128K GD32E505 180MHz, 512K/128K GD32E503 180MHz, 512K/128K	
	Mainstream	GD32L233 64MHz, 256K/32K	GD32F107 108MHz, 1M/96K GD32F105 108MHz, 1M/96K GD32F103 108MHz, 3M/96K GD32F101 56MHz, 3M/80K	GD32F307 120MHz, 1M/96K GD32F305 120MHz, 1M/96K GD32F303 120MHz, 3M/96K	GD32C113 120MHz, 128K/32K GD32E113 120MHz, 128K/32K GD32C103 120MHz, 128K/32K GD32E103 120MHz, 128K/32K	GD32E501 100MHz, 512K/32K
Entry-Level	GD32E232 72MHz, 64K/8K GD32E230 72MHz, 64K/8K	GD32F150 72MHz, 64K/8K GD32F130 48MHz, 64K/8K	GD32F350 108MHz, 128K/16K GD32F330 84MHz, 128K/16K GD32F310 72MHz, 64K/8K			
Specific			GD32FFPR 168MHz, 1M/128K	GD32EPRT 168MHz, 384K/96K+4M		

GD32 Cortex-M3 MCU 200+ PNs

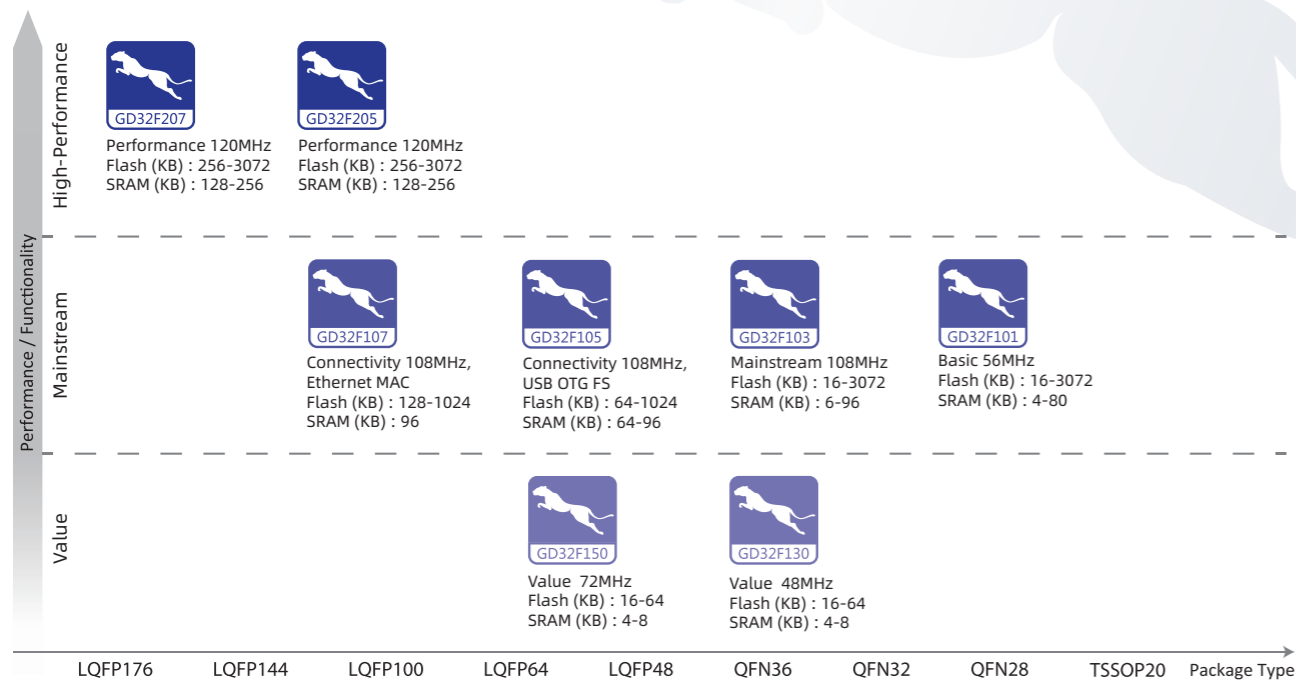

GD32 Cortex-M23 MCU 30+ PNs GD32E23x Series MCU

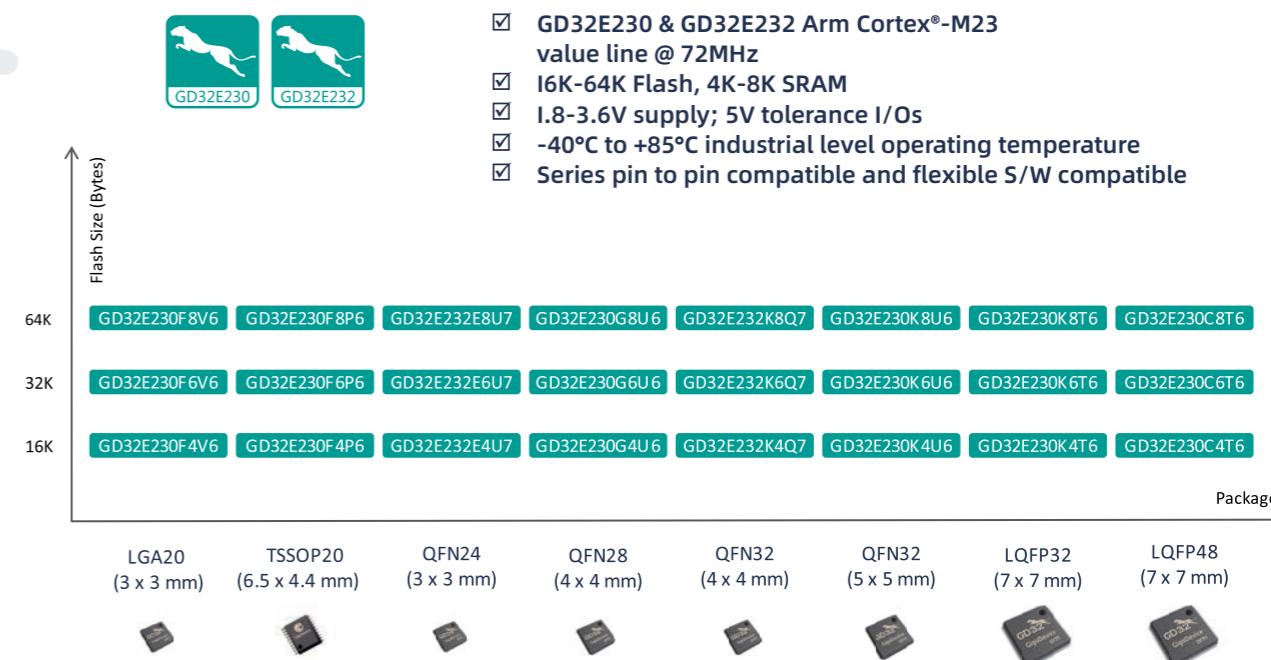

GD32 Cortex-M4 MCU 100+ PNs

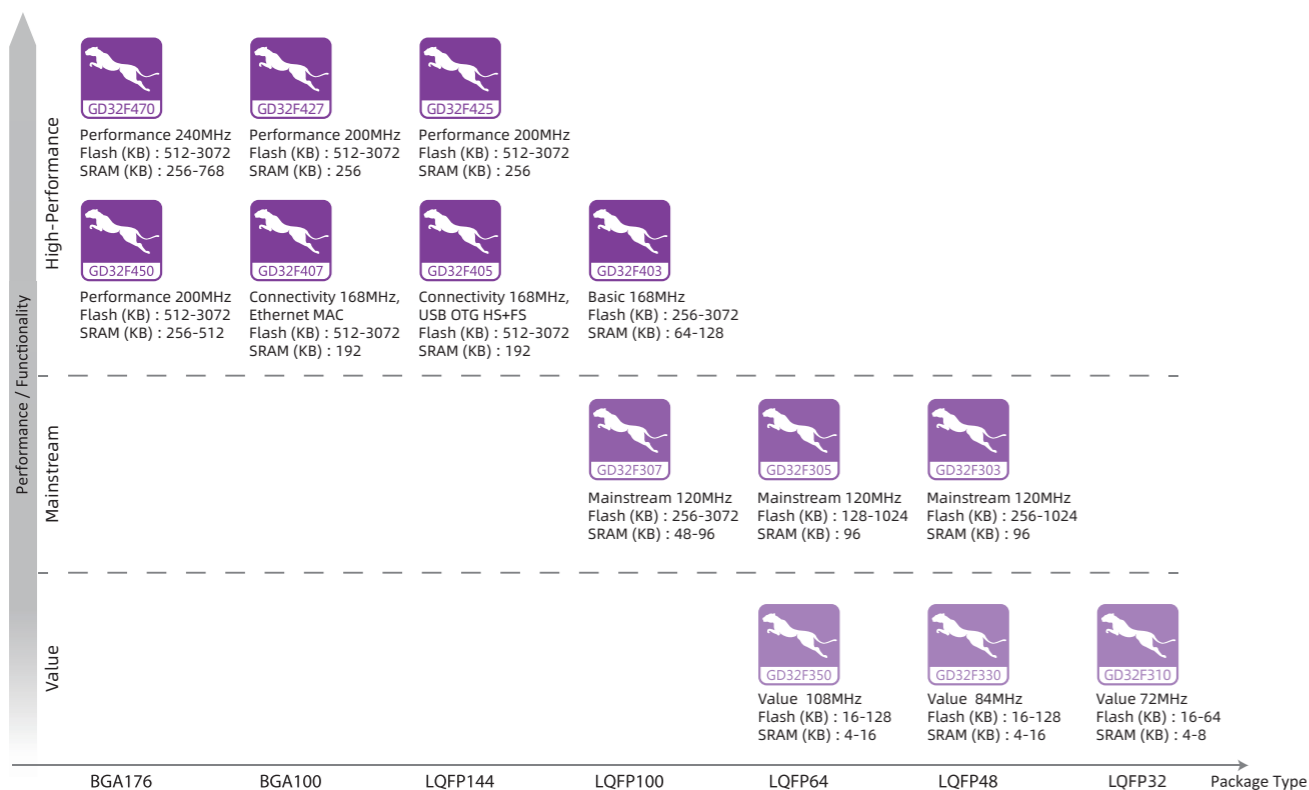

GD32 Cortex-M23 MCU 30+ PNs GD32L233 Series of Low-power MCU

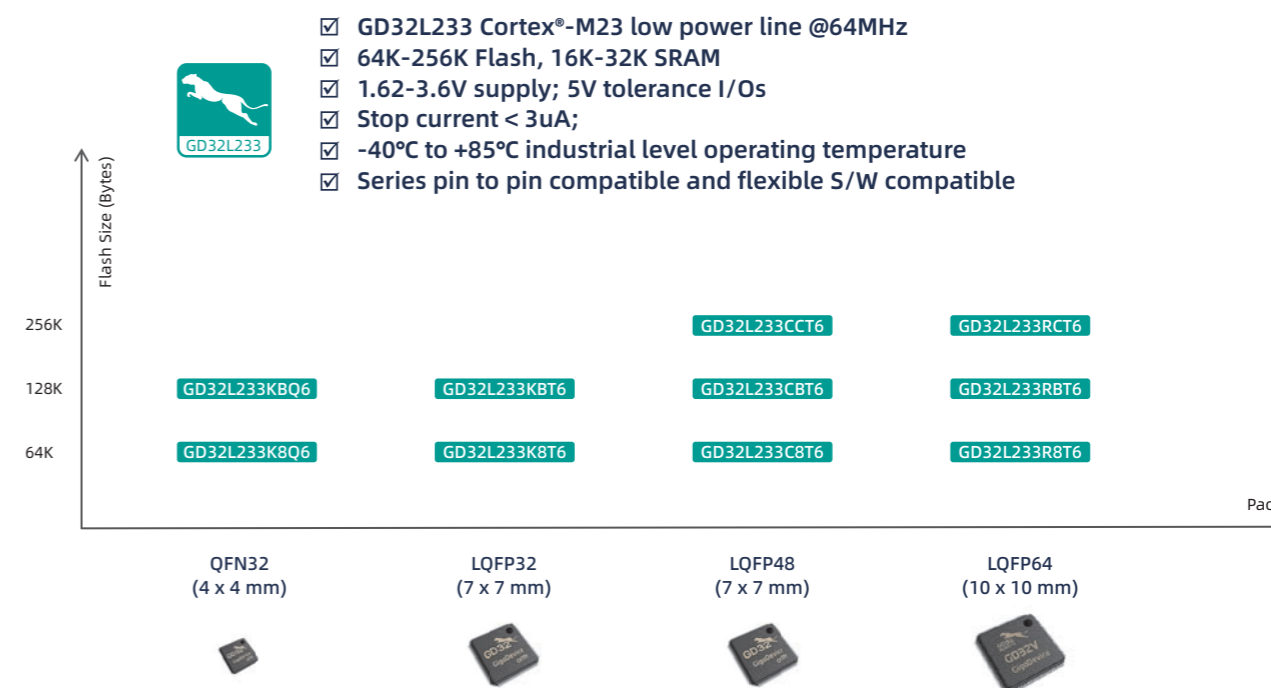

GD32 Cortex-M33 MCU 30+ PNs GD32E5 Series MCU



- ☑ GD32E503/505/507/508/PRT High-performance line
- ☑ Cortex®-M33 @180MHz
- ☑ 128-512KB eFlash, 80-128KB SRAM
- ☑ 1.7-3.6V supply; 5V tolerance I/Os
- ☑ -40°C to +85°C industrial level operating temperature
- ☑ Series pin to pin compatible and flexible S/W compatible



GD32VF103 RISC-V MCU 14 PNs



- ☑ GD32VF103 RISC-V Bumblebee Core Mainstream Line
- ☑ Max F_{cpu} 108MHz, 16K-128K Flash, 6K-32K SRAM
- ☑ 2.6-3.6V supply; 5V tolerance I/Os; all support USB OTG & CAN 2.0B
- ☑ -40°C to +85°C industrial level operating temperature
- ☑ Series pin to pin compatible and flexible S/W compatible

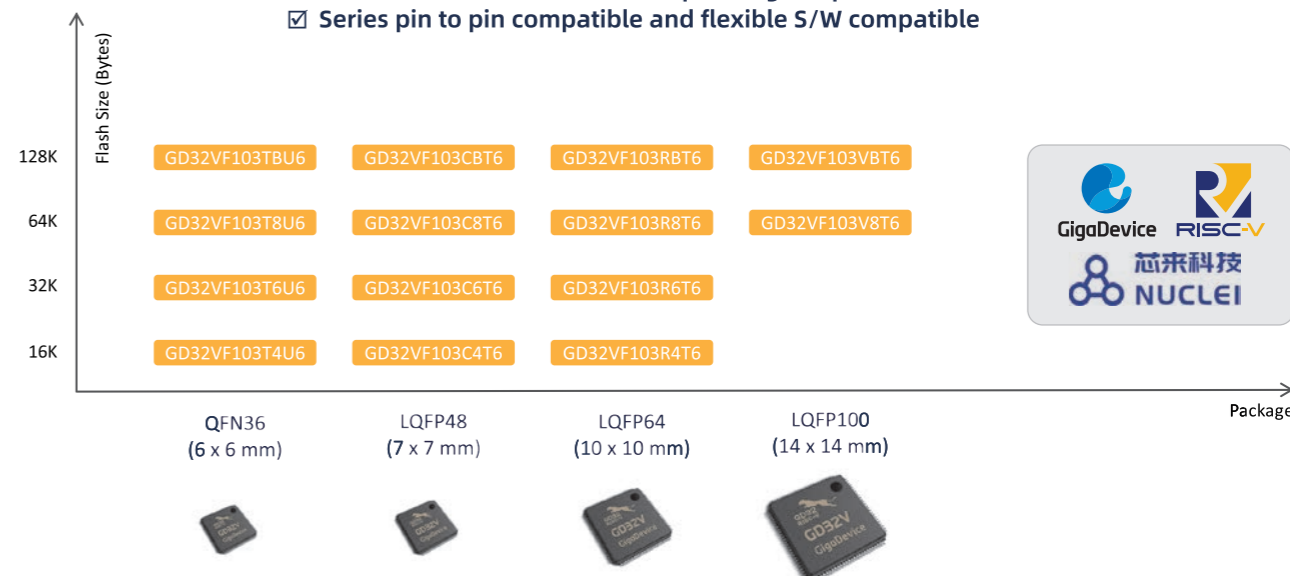

GD32 Cortex-M33 MCU 30+ PNs GD32W5 Series of Wireless MCU



- ☑ GD32W515 Cortex®-M33 wireless line @180MHz
- ☑ 0K-2048K Flash, 384K-448K SRAM
- ☑ 1.62-3.63V supply; 5V tolerance I/Os
- ☑ -40°C to +85°C industrial level operating temperature
- ☑ Series pin to pin compatible and flexible S/W compatible

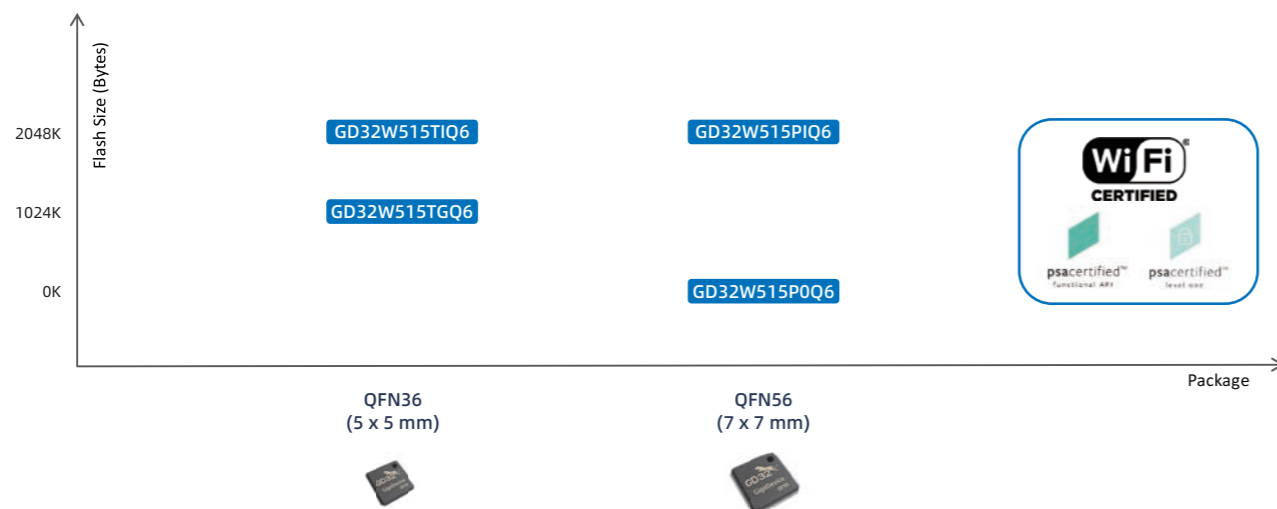

MCU Package Options

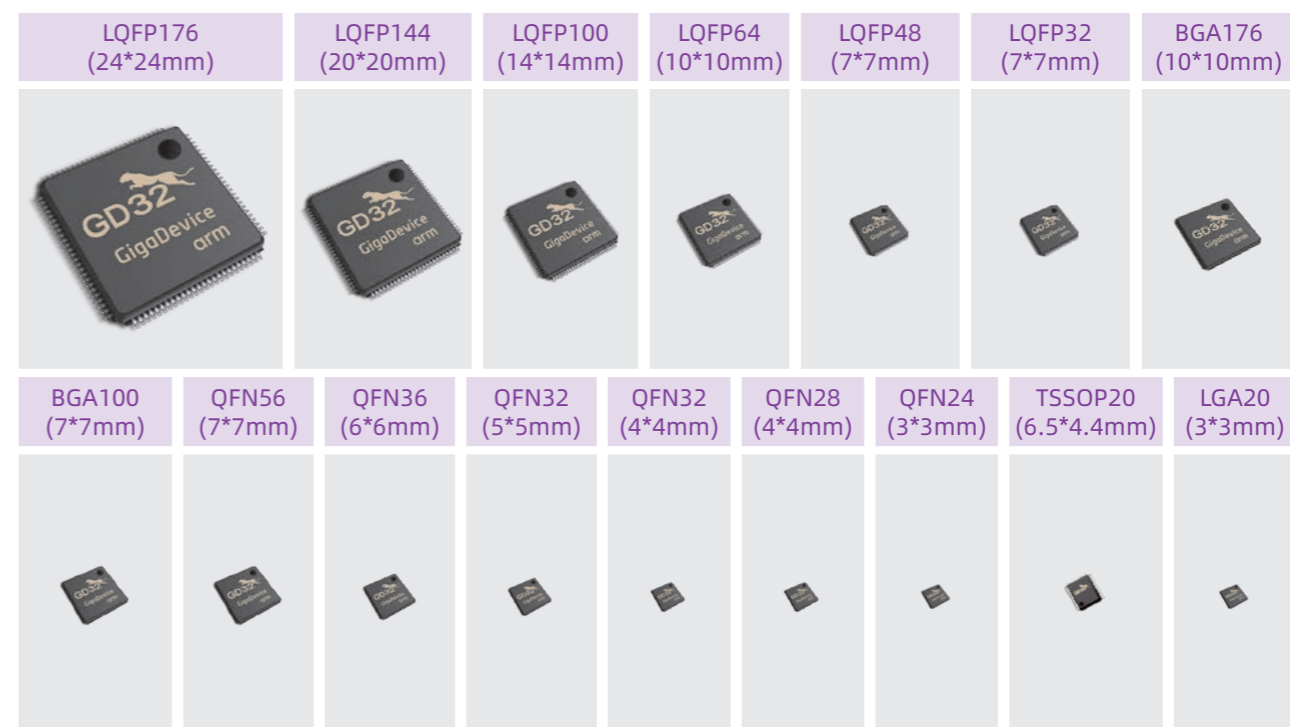

GD32 Development Ecosystem



 A grid of logos representing the GD32 development ecosystem partners and certifications. The logos are arranged in four rows:

- Row 1: arm KEIL, SEGGER, IAR SYSTEMS, Embeeble IDE, CrossWorks, PE micro, ARM mbed enabled.
- Row 2: aws, Microsoft Azure, freeRTOS, RT-Thread, TencentOS Tiny, 0x5 HEX-Five, sensory™.
- Row 3: Algocraft®, ELNEC, SMH Technologies®, 创芯工坊 (Chuangxin Workshop), XELTEK SuperBOT Automated Equipment Company, Wellon®, ZLG 致远电子.
- Row 4: CERTIFIED USB, WiFi CERTIFIED, psacertified™ level one, RISC-V®, 芯来科技 NUCLEI, GNU MCU, GCC, Tmall 天猫 GD32官方旗舰店 (GD32 Official Flagship Store), GD MCU/EMMC/FLASH/GD-LINK.

All trademarks are property of their respective owners.

GD32W5 series of 32-bit ARM® Cortex®-M33 Wireless MCUs Selection Guide



Series	Part No.	Max Speed (MHz)	Memory(Bytes)		I/O	Timer							Connectivity										Analog Interface		Package	
			Flash	SRAM		GPTM (32bit)	GPTM (16bit)	Advanced TM (16bit)	Basic TM (16bit)	SysTick (24bit)	WDG	RTC	USART	I ² C	SPI	USB 2.0 FS	I ² S	SD IO	IEEE 802.11	QS PI	Digital Filters	Digital Camera	HW Security	12bit ADC Units (CHs)		Cap. Touch Key
GD32W515	GD32W515TGQ6	180	1024K	384K	up to 25	2	3	1	1	1	2	1	3	2	2	OTG	1	1	b/g/n	1			•	1(5)	7	QFN36
	GD32W515TIQ6	180	2048K	448K	up to 25	2	3	1	1	1	2	1	3	2	2	OTG	1	1	b/g/n	1			•	1(5)	7	QFN36
	GD32W515POQ6	180	0K	448K	up to 43	2	4	1	1	1	2	1	3	2	2	OTG	1	1	b/g/n	1	•	•	•	1(9)	12	QFN56
	GD32W515PIQ6	180	2048K	448K	up to 43	2	4	1	1	1	2	1	3	2	2	OTG	1	1	b/g/n	1	•	•	•	1(9)	12	QFN56

GD32L23x series of 32-bit ARM® Cortex®-M23 Low-power Consumption MCUs Selection Guide



Series	Part No.	Max Speed (MHz)	Memory(Bytes)		I/O	Timer							Connectivity								Analog Interface		Package			
			Flash	SRAM		LPTM (32bit)	GPTM (16bit)	Advanced TM (16bit)	Basic TM (16bit)	SysTick (24bit)	WDG	RTC	USAR +UART	LP UART	I ² C	SPI	USB 2.0	I ² S	Comp	Segment LCD	12bit ADC Units (CHs)	12bit DAC Units				
GD32L233	GD32L233K8Q6	64	64K	16K	up to 29	1	3	0	2	1	2	1	2+1	1	2	2	FS	1	2					1(10)	1	QFN32
	GD32L233KBQ6	64	128K	24K	up to 29	1	3	0	2	1	2	1	2+1	1	2	2	FS	1	2					1(10)	1	QFN32
	GD32L233K8T6	64	64K	16K	up to 27	1	3	0	2	1	2	1	2+1	1	2	2	FS	1	2					1(10)	1	LQFP32
	GD32L233KBT6	64	128K	24K	up to 27	1	3	0	2	1	2	1	2+1	1	2	2	FS	1	2					1(10)	1	LQFP32
	GD32L233C8T6	64	64K	16K	up to 43	1	3	0	2	1	2	1	2+1	1	2	2	FS	1	2					1(10)	1	LQFP48
	GD32L233CBT6	64	128K	24K	up to 43	1	4	0	2	1	2	1	2+2	1	2	2	FS	1	2					1(10)	1	LQFP48
	GD32L233CCT6	64	256K	32K	up to 43	1	4	0	2	1	2	1	2+2	1	2	2	FS	1	2					1(10)	1	LQFP48
	GD32L233R8T6	64	64K	16K	up to 59	1	3	0	2	1	2	1	2+1	1	3	2	FS	1	2	8*28/4*32				1(16)	1	LQFP64
	GD32L233RBT6	64	128K	24K	up to 59	1	4	0	2	1	2	1	2+2	1	3	2	FS	1	2	8*28/4*32				1(16)	1	LQFP64
	GD32L233RCT6	64	256K	32K	up to 59	1	4	0	2	1	2	1	2+2	1	3	2	FS	1	2	8*28/4*32				1(16)	1	LQFP64

GD32E5 series of 32-bit ARM® Cortex®-M33 MCUs Selection Guide



Series	Part No.	Max Speed (MHz)	Memory (Bytes)		I/O	Timer							Connectivity										EX MC	Analog Interface		Package					
			Flash	SRAM		GPTM (32bit)	GPTM (16bit)	Advanced TM (16bit)	Bsc TM (16bit)	SysTick (24bit)	WDG	RTC	USART +UART	I ² C	SPI	CAN 2.0B	USB 2.0	I ² S	SD IO	Ethernet	TMU	SH RTM		Co mp	12bit ADC Units (CHs)		12bit DAC Units				
GD32E503	GD32E503CCT6	180	256K	96K	up to 37	1	3	1	2	1	2	1	3+0	3	3	2	FS	2											3(10)	2	LQFP48
	GD32E503CET6	180	512K	128K	up to 37	1	9	1	2	1	2	1	3+0	3	3	2	FS	2											3(10)	2	LQFP48
	GD32E503RCT6	180	256K	96K	up to 51	1	3	2	2	1	2	1	4+2	3	3	2	FS	2	1										3(16)	2	LQFP64
	GD32E503RET6	180	512K	128K	up to 51	1	9	2	2	1	2	1	4+2	3	3	2	FS	2	1										3(16)	2	LQFP64
	GD32E503VCT6	180	256K	96K	up to 80	1	3	2	2	1	2	1	4+2	3	3	2	FS	2	1										3(16)	2	LQFP100
	GD32E503VET6	180	512K	128K	up to 80	1	9	2	2	1	2	1	4+2	3	3	2	FS	2	1										3(16)	2	LQFP100
	GD32E503ZCT6	180	256K	96K	up to 112	1	3	2	2	1	2	1	4+2	3	3	2	FS	2	1										3(21)	2	LQFP144
	GD32E503ZET6	180	512K	128K	up to 112	1	9	2	2	1	2	1	4+2	3	3	2	FS	2	1										3(21)	2	LQFP144
GD32E505	GD32E505RBT6	180	128K	80K	up to 51	1	3	1	2	1	2	1	4+2	3	3	3	HS OTG	2											2(16)	2	LQFP64
	GD32E505RCT6	180	256K	96K	up to 51	1	3	1	2	1	2	1	4+2	3	3	3	HS OTG	2											2(16)	2	LQFP64
	GD32E505RET6	180	512K	128K	up to 51	1	9	2	2	1	2	1	4+2	3	3	3	HS OTG	2											2(16)	2	LQFP64
	GD32E505VCT6	180	256K	96K	up to 80	1	3	1	2	1	2	1	4+2	3	3	3	HS OTG	2											2(16)	2	LQFP100
	GD32E505VET6	180	512K	128K	up to 80	1	9	2	2	1	2	1	4+2	3	3	3	HS OTG	2											2(16)	2	LQFP100
	GD32E505ZCT6	180	256K	96K	up to 112	1	3	2	2	1	2	1	4+2	3	3	3	HS OTG	2											2(16)	2	LQFP144
	GD32E505ZET6	180	512K	128K	up to 112	1	9	2	2	1	2	1	4+2	3	3	3	HS OTG	2											2(16)	2	LQFP144
GD32E507	GD32E507RCT6	180	256K	96K	up to 51	1	3	1	2	1	2	1	4+2	3	3	3	HS OTG	2											2(16)	2	LQFP64
	GD32E507RET6	180	512K	128K	up to 51	1	9	2	2	1	2	1	4+2	3	3	3	HS OTG	2											2(16)	2	LQFP64
	GD32E507VCT6	180	256K	96K	up to 80	1	3	1	2	1	2	1	4+2	3	3	3	HS OTG	2											2(16)	2	LQFP100
	GD32E507VET6	180	512K	128K	up to 80	1	9	2	2	1	2	1	4+2	3	3	3	HS OTG	2											2(16)	2	LQFP100
	GD32E507ZCT6	180	256K	96K	up to 112	1	3	2	2	1	2	1	4+2	3	3	3	HS OTG	2											2(16)	2	LQFP144
	GD32E507ZET6	180	512K	128K	up to 112	1	9	2	2	1	2	1	4+2	3	3	3	HS OTG	2											2(16)	2	LQFP144
GD32E508	GD32E508RET6	180	512K	128K	up to 51	1	9	2	2	1	2	1	4+2	3	3	3xFD	HS OTG	2											2(16)	2	LQFP64
	GD32E508VET6	180	512K	128K	up to 80	1	9	2	2	1	2	1	4+2	3	3	3xFD	HS OTG	2											2(16)	2	LQFP100
	GD32E508ZET6	180	512K	128K	up to 112	1	9	2	2	1	2	1	4+2	3	3	3xFD	HS OTG	2											2(16)	2	LQFP144
GD32EPRT	GD32EPRTD6	180	384K	96K+4MB PSRAM	up to 51	1	3	2	2	1	2	1	3+3	3	3		FS	2											3(16)	2	LQFP64
	GD32EPRTVDT6	180	384K	96K+4MB PSRAM	up to 80	1	3	2	2	1	2	1	3+3	3	3		FS	2											3(16)	2	LQFP100

GD32V series of 32-bit RISC-V MCUs Selection Guide



Series	Part No.	Max Speed (MHz)	Memory (Bytes)		I/O	Timer						Connectivity						EXMC	Analog Interface		Package		
			Flash	SRAM		GPTM (16bit)	Advanced TM (16bit)	Basic TM (16bit)	SysTick (24bit)	WDG	RTC	USART +UART	I ² C	SPI	CAN 2.0B	USB 2.0 FS	I ² S		SDIO	Ethernet		12bit ADC Units (CHs)	12bit DAC Units
GD32VF103	GD32VF103T4U6	108	16K	6K	up to 26	2	1	2	1	2	1	2+0	1	1	2	OTG					2(10)	2	QFN36
	GD32VF103T6U6	108	32K	10K	up to 26	2	1	2	1	2	1	2+0	1	1	2	OTG					2(10)	2	QFN36
	GD32VF103T8U6	108	64K	20K	up to 26	4	1	2	1	2	1	2+0	1	1	2	OTG					2(10)	2	QFN36
	GD32VF103TBU6	108	128K	32K	up to 26	4	1	2	1	2	1	2+0	1	1	2	OTG					2(10)	2	QFN36
	GD32VF103C4T6	108	16K	6K	up to 37	2	1	2	1	2	1	2+0	1	1	2	OTG					2(10)	2	LQFP48
	GD32VF103C6T6	108	32K	10K	up to 37	2	1	2	1	2	1	2+0	1	1	2	OTG					2(10)	2	LQFP48
	GD32VF103C8T6	108	64K	20K	up to 37	4	1	2	1	2	1	3+0	2	3	2	OTG	2				2(10)	2	LQFP48
	GD32VF103CBT6	108	128K	32K	up to 37	4	1	2	1	2	1	3+0	2	3	2	OTG	2				2(10)	2	LQFP48
	GD32VF103R4T6	108	16K	6K	up to 51	2	1	2	1	2	1	2+0	1	1	2	OTG					2(16)	2	LQFP64
	GD32VF103R6T6	108	32K	10K	up to 51	2	1	2	1	2	1	2+0	1	1	2	OTG					2(16)	2	LQFP64
	GD32VF103R8T6	108	64K	20K	up to 51	4	1	2	1	2	1	3+2	2	3	2	OTG	2				2(16)	2	LQFP64
	GD32VF103RBT6	108	128K	32K	up to 51	4	1	2	1	2	1	3+2	2	3	2	OTG	2				2(16)	2	LQFP64
	GD32VF103V8T6	108	64K	20K	up to 80	4	1	2	1	2	1	3+2	2	3	2	OTG	2			•	2(16)	2	LQFP100
GD32VF103VBT6	108	128K	32K	up to 80	4	1	2	1	2	1	3+2	2	3	2	OTG	2			•	2(16)	2	LQFP100	

GD32E23x series of 32-bit ARM® Cortex®-M23 MCUs Selection Guide



Series	Part No.	Max Speed (MHz)	Memory (Bytes)		I/O	Timer						Connectivity						Analog Interface		Package			
			Flash	SRAM		GPTM (32bit)	GPTM (16bit)	Advanced TM (16bit)	Basic TM (16bit)	SysTick (24bit)	WDG	RTC	USART	I ² C	SPI	USB 2.0 FS	I ² S	Comp	OP-AMP		12bit ADC Units (CHs)	12bit DAC Units	
GD32E230	GD32E230F4P6TR	72	16K	4K	up to 15		4	1	1	1	2	1	1	1	1	1	1	1			1(9)		TSSOP20
	GD32E230F6P6TR	72	32K	6K	up to 15		4	1	1	1	2	1	2	1	1		1	1			1(9)		TSSOP20
	GD32E230F8P6TR	72	64K	8K	up to 15		4	1	1	1	2	1	2	2	2		1	1			1(9)		TSSOP20
	GD32E230F4V6TR	72	16K	4K	up to 15		4	1	1	1	2	1	1	1	1		1	1			1(9)		LGA20
	GD32E230F6V6TR	72	32K	6K	up to 15		4	1	1	1	2	1	2	1	1		1	1			1(9)		LGA20
	GD32E230F8V6TR	72	64K	8K	up to 15		4	1	1	1	2	1	2	2	2		1	1			1(9)		LGA20
	GD32E230G4U6TR	72	16K	4K	up to 23		4	1	1	1	2	1	1	1	1		1	1			1(10)		QFN28
	GD32E230G6U6TR	72	32K	6K	up to 23		4	1	1	1	2	1	2	1	1		1	1			1(10)		QFN28
	GD32E230G8U6TR	72	64K	8K	up to 23		5	1	1	1	2	1	2	2	2		1	1			1(10)		QFN28
	GD32E230K4U6	72	16K	4K	up to 27		4	1	1	1	2	1	1	1	1		1	1			1(10)		QFN32
	GD32E230K6U6	72	32K	6K	up to 27		4	1	1	1	2	1	2	1	1		1	1			1(10)		QFN32
	GD32E230K8U6	72	64K	8K	up to 27		5	1	1	1	2	1	2	2	2		1	1			1(10)		QFN32
	GD32E230K4T6	72	16K	4K	up to 25		4	1	1	1	2	1	1	1	1		1	1			1(10)		LQFP32

GD32E23x series of 32-bit ARM® Cortex®-M23 MCUs Selection Guide



Series	Part No.	Max Speed (MHz)	Memory (Bytes)		I/O	Timer							Connectivity						Analog Interface		Package	
			Flash	SRAM		GPTM (32bit)	GPTM (16bit)	Advanced TM (16bit)	Basic TM (16bit)	SysTick (24bit)	WDG	RTC	USART	I ² C	SPI	USB 2.0 FS	I ² S	Comp	OP-AMP	12bit ADC Units (CHs)		12bit DAC Units
GD32E230	GD32E230K6T6	72	32K	6K	up to 25		4	1	1	1	2	1	2	1	1		1	1		1(10)		LQFP32
	GD32E230K8T6	72	64K	8K	up to 25		5	1	1	1	2	1	2	2		1	1		1(10)		LQFP32	
	GD32E230C4T6	72	16K	4K	up to 39		4	1	1	1	2	1	1	1	1		1	1		1(10)		LQFP48
	GD32E230C6T6	72	32K	6K	up to 39		4	1	1	1	2	1	2	1	1		1	1		1(10)		LQFP48
	GD32E230C8T6	72	64K	8K	up to 39		5	1	1	1	2	1	2	2	2		1	1		1(10)		LQFP48
GD32E232	GD32E232E4U7TR	72	16K	4K	up to 18	1	4	1	2	1	2	1	2	2	1		1			1(9)	4	QFN24
	GD32E232E6U7TR	72	32K	6K	up to 18	1	4	1	2	1	2	1	2	2	1		1			1(9)	4	QFN24
	GD32E232E8U7TR	72	64K	8K	up to 18	1	5	1	2	1	2	1	2	2	2		1			1(9)	4	QFN24
	GD32E232K4Q7TR	72	16K	4K	up to 28	1	4	1	2	1	2	1	2	2	1		1			1(16)	4	QFN32
	GD32E232K6Q7TR	72	32K	6K	up to 28	1	4	1	2	1	2	1	2	2	1		1			1(16)	4	QFN32
	GD32E232K8Q7TR	72	64K	8K	up to 28	1	5	1	2	1	2	1	2	2	2		1			1(16)	4	QFN32

GD32E1 series of 32-bit ARM® Cortex®-M4 MCUs Selection Guide



Series	Part No.	Max Speed (MHz)	Memory (Bytes)		I/O	Timer						Connectivity							EXMC	Analog Interface		Package	
			Flash	SRAM		GPTM (16bit)	Adv TM (16bit)	Bsc TM (16bit)	SysTick (24bit)	WDG	RTC	USART +UART	I ² C	SPI	CAN 2.0B	USB 2.0 FS	I ² S	SDIO		Ethernet	12bit ADC Units (CHs)		12bit DAC Units
GD32E113	GD32E113T8U6	120	64K	20K	up to 26	4	1	2	1	2	1	2+0	1	1		OTG					2(10)	2	QFN36
	GD32E113TBU6	120	128K	32K	up to 26	4	1	2	1	2	1	2+0	1	1		OTG					2(10)	2	QFN36
	GD32E113C8T6	120	64K	20K	up to 37	10	1	2	1	2	1	3+0	2	3		OTG	2				2(10)	2	LQFP48
	GD32E113CBT6	120	128K	32K	up to 37	10	1	2	1	2	1	3+0	2	3		OTG	2				2(10)	2	LQFP48
	GD32E113R8T6	120	64K	20K	up to 51	10	2	2	1	2	1	3+2	2	3		OTG	2				2(16)	2	LQFP64
	GD32E113RBT6	120	128K	32K	up to 51	10	2	2	1	2	1	3+2	2	3		OTG	2				2(16)	2	LQFP64
	GD32E113V8T6	120	64K	20K	up to 80	10	2	2	1	2	1	3+2	2	3		OTG	2			•	2(16)	2	LQFP100
GD32C113	GD32E113VBT6	120	128K	32K	up to 80	10	2	2	1	2	1	3+2	2	3		OTG	2			•	2(16)	2	LQFP100
	GD32C113TBU6	120	128K	32K	up to 26	4	1	2	1	2	1	2+0	1	1	2 x FD	OTG					2(10)	2	QFN36
	GD32C113CBT6	120	128K	32K	up to 37	10	1	2	1	2	1	3+0	2	3	2 x FD	OTG	2				2(10)	2	LQFP48
	GD32C113RBT6	120	128K	32K	up to 51	10	2	2	1	2	1	3+2	2	3	2 x FD	OTG	2				2(16)	2	LQFP64
GD32C113VBT6	120	128K	32K	up to 80	10	2	2	1	2	1	3+2	2	3	2 x FD	OTG	2			•	2(16)	2	LQFP100	

Series	Part No.	Max Speed (MHz)	Memory (Bytes)		I/O	Timer						Connectivity							EXMC	Analog Interface		Package	
			Flash	SRAM		GPTM (16bit)	Adv TM (16bit)	Bsc TM (16bit)	SysTick (24bit)	WDG	RTC	USART +UART	I ² C	SPI	CAN 2.0B	USB 2.0 FS	I ² S	SDIO		Ethernet	12bit ADC Units (CHs)		12bit DAC Units
GD32E103	GD32E103T8U6	120	64K	20K	up to 26	4	1	2	1	2	1	2+0	1	1		OTG					2(10)	2	QFN36
	GD32E103TBU6	120	128K	32K	up to 26	4	1	2	1	2	1	2+0	1	1		OTG					2(10)	2	QFN36
	GD32E103C8T6	120	64K	20K	up to 37	10	1	2	1	2	1	3+0	2	3		OTG	2				2(10)	2	LQFP48
	GD32E103CBT6	120	128K	32K	up to 37	10	1	2	1	2	1	3+0	2	3		OTG	2				2(10)	2	LQFP48
	GD32E103R8T6	120	64K	20K	up to 51	10	2	2	1	2	1	3+2	2	3		OTG	2				2(16)	2	LQFP64
	GD32E103RBT6	120	128K	32K	up to 51	10	2	2	1	2	1	3+2	2	3		OTG	2				2(16)	2	LQFP64
	GD32E103V8T6	120	64K	20K	up to 80	10	2	2	1	2	1	3+2	2	3		OTG	2			•	2(16)	2	LQFP100
GD32C103	GD32E103VBT6	120	128K	32K	up to 80	10	2	2	1	2	1	3+2	2	3		OTG	2			•	2(16)	2	LQFP100
	GD32C103TBU6	120	128K	32K	up to 26	4	1	2	1	2	1	2+0	1	1	2 x FD	OTG					2(10)	2	QFN36
	GD32C103CBT6	120	128K	32K	up to 37	10	1	2	1	2	1	3+0	2	3	2 x FD	OTG	2				2(10)	2	LQFP48
	GD32C103RBT6	120	128K	32K	up to 51	10	2	2	1	2	1	3+2	2	3	2 x FD	OTG	2				2(16)	2	LQFP64
GD32C103VBT6	120	128K	32K	up to 80	10	2	2	1	2	1	3+2	2	3	2 x FD	OTG	2			•	2(16)	2	LQFP100	

GD32F4 series of 32-bit ARM® Cortex®-M4 MCUs Selection Guide



Series	Part No.	Max Speed (MHz)	Memory (Bytes)		I/O	Timer						Connectivity										EXMC/SDRAM	Analog Interface		Package				
			Flash	SRAM		GPTM (16bit)	Adv TM (16bit)	GPTM (32bit)	Bsc TM (16bit)	WDG	RTC	USART +UART	I ² C	SPI	CAN 2.0B	USB OTG	I ² S	SDIO	LCD-TFT	Camera	ETH MAC		IPA	12bit ADC Units (CHs)		12bit DAC Units			
GD32F425	GD32F425RET6	200	512K	256K	up to 51	8	2	2	2	2	1	4+2	3	3	2	FS+HS	2	1		1							3(16)	2	LQFP64
	GD32F425RGT6	200	1024K	256K	up to 51	8	2	2	2	2	1	4+2	3	3	2	FS+HS	2	1		1							3(16)	2	LQFP64
	GD32F425RKT6	200	3072K	256K	up to 51	8	2	2	2	2	1	4+2	3	3	2	FS+HS	2	1		1							3(16)	2	LQFP64
	GD32F425VGT6	200	1024K	256K	up to 82	8	2	2	2	2	1	4+2	3	3	2	FS+HS	2	1		1							3(16)	2	LQFP100
	GD32F425VKT6	200	3072K	256K	up to 82	8	2	2	2	2	1	4+2	3	3	2	FS+HS	2	1		1							3(16)	2	LQFP100
	GD32F425VGH6	200	1024K	256K	up to 82	8	2	2	2	2	1	4+2	3	3	2	FS+HS	2	1		1							3(16)	2	BGA100
	GD32F425VKH6	200	3072K	256K	up to 82	8	2	2	2	2	1	4+2	3	3	2	FS+HS	2	1		1							3(16)	2	BGA100
	GD32F425ZGT6	200	1024K	256K	up to 114	8	2	2	2	2	1	4+2	3	3	2	FS+HS	2	1		1							3(24)	2	LQFP144
GD32F427	GD32F427RET6	200	512K	256K	up to 51	8	2	2	2	2	1	4+2	3	3	2	FS+HS	2	1		1	1						3(16)	2	LQFP64
	GD32F427RGT6	200	1024K	256K	up to 51	8	2	2	2	2	1	4+2	3	3	2	FS+HS	2	1		1	1						3(16)	2	LQFP64
	GD32F427RKT6	200	3072K	256K	up to 51	8	2	2	2	2	1	4+2	3	3	2	FS+HS	2	1		1	1						3(16)	2	LQFP64
	GD32F427VET6	200	512K	256K	up to 82	8	2	2	2	2	1	4+2	3	3	2	FS+HS	2	1		1	1		1/0				3(16)	2	LQFP100
	GD32F427VGT6	200	1024K	256K	up to 82	8	2	2	2	2	1	4+2	3	3	2	FS+HS	2	1		1	1		1/0				3(16)	2	LQFP100
	GD32F427VKT6	200	3072K	256K	up to 82	8	2	2	2	2	1	4+2	3	3	2	FS+HS	2	1		1	1		1/0				3(16)	2	LQFP100
	GD32F427VEH6	200	512K	256K	up to 82	8	2	2	2	2	1	4+2	3	3	2	FS+HS	2	1		1	1		1/0				3(16)	2	BGA100
	GD32F427VGH6	200	1024K	256K	up to 82	8	2	2	2	2	1	4+2	3	3	2	FS+HS	2	1		1	1		1/0				3(16)	2	BGA100
	GD32F427VKH6	200	3072K	256K	up to 82	8	2	2	2	2	1	4+2	3	3	2	FS+HS	2	1		1	1		1/0				3(16)	2	BGA100
	GD32F427ZET6	200	512K	256K	up to 114	8	2	2	2	2	1	4+2	3	3	2	FS+HS	2	1		1	1		1/1				3(24)	2	LQFP144
	GD32F427ZGT6	200	1024K	256K	up to 114	8	2	2	2	2	1	4+2	3	3	2	FS+HS	2	1		1	1		1/1				3(24)	2	LQFP144
	GD32F427ZKT6	200	3072K	256K	up to 114	8	2	2	2	2	1	4+2	3	3	2	FS+HS	2	1		1	1		1/1				3(24)	2	LQFP144
	GD32F427IEH6	200	512K	256K	up to 140	8	2	2	2	2	1	4+2	3	3	2	FS+HS	2	1		1	1		1/1				3(24)	2	BGA176
	GD32F427IGH6	200	1024K	256K	up to 140	8	2	2	2	2	1	4+2	3	3	2	FS+HS	2	1		1	1		1/1				3(24)	2	BGA176
	GD32F427IKH6	200	3072K	256K	up to 140	8	2	2	2	2	1	4+2	3	3	2	FS+HS	2	1		1	1		1/1				3(24)	2	BGA176
	GD32F470	GD32F470VET6	240	512K	256K	up to 82	8	2	2	2	2	1	4+4	3	5	2	FS+HS	2	1	1	1	1	1	1/0				3(16)	2
GD32F470VGT6		240	1024K	512K	up to 82	8	2	2	2	2	1	4+4	3	5	2	FS+HS	2	1	1	1	1	1	1/0				3(16)	2	LQFP100
GD32F470VIT6		240	2048K	768K	up to 82	8	2	2	2	2	1	4+4	3	5	2	FS+HS	2	1	1	1	1	1	1/0				3(16)	2	LQFP100
GD32F470VKT6		240	3072K	256K	up to 82	8	2	2	2	2	1	4+4	3	5	2	FS+HS	2	1	1	1	1	1	1/0				3(16)	2	LQFP100
GD32F470VGH6		240	1024K	512K	up to 82	8	2	2	2	2	1	4+4	3	5	2	FS+HS	2	1	1	1	1	1	1/0				3(16)	2	BGA100
GD32F470VIH6		240	2048K	768K	up to 82	8	2	2	2	2	1	4+4	3	5	2	FS+HS	2	1	1	1	1	1	1/0				3(16)	2	BGA100
GD32F470VKH6		240	3072K	256K	up to 82	8	2	2	2	2	1	4+4	3	5	2	FS+HS	2	1	1	1	1	1	1/0				3(16)	2	BGA100
GD32F470ZET6		240	512K	256K	up to 114	8	2	2	2	2	1	4+4	3	6	2	FS+HS	2	1	1	1	1	1	1/1				3(24)	2	LQFP144
GD32F470ZGT6		240	1024K	512K	up to 114	8	2	2	2	2	1	4+4	3	6	2	FS+HS	2	1	1	1	1	1	1/1				3(24)	2	LQFP144
GD32F470ZIT6		240	2048K	768K	up to 114	8	2	2	2	2	1	4+4	3	6	2	FS+HS	2	1	1	1	1	1	1/1				3(24)	2	LQFP144
GD32F470ZKT6		240	3072K	256K	up to 114	8	2	2	2	2	1	4+4	3	6	2	FS+HS	2	1	1	1	1	1	1/1				3(24)	2	LQFP144
GD32F470IGH6		240	1024K	512K	up to 140	8	2	2	2	2	1	4+4	3	6	2	FS+HS	2	1	1	1	1	1	1/1				3(24)	2	BGA176
GD32F470IIH6		240	2048K	768K	up to 140	8	2	2	2	2	1	4+4	3	6	2	FS+HS	2	1	1	1	1	1	1/1				3(24)	2	BGA176
GD32F470IKH6		240	3072K	256K	up to 140	8	2	2	2	2	1	4+4	3	6	2	FS+HS	2	1	1	1	1	1	1/1				3(24)	2	BGA176

Series	Part No.	Max Speed (MHz)	Memory (Bytes)		I/O	Timer						Connectivity										EXMC/SDRAM	Analog Interface		Package	
			Flash	SRAM		GPTM (16bit)	Adv TM (16bit)	GPTM (32bit)	Bsc TM (16bit)	WDG	RTC	USART +UART	I ² C	SPI	CAN 2.0B	USB OTG	I ² S	SDIO	LCD-TFT	Cam era	ETH MAC		IPA	12bit ADC Units (CHs)		12bit DAC Units
GD32F403	GD32F403RCT6	168	256K	64K	up to 51	8	2		2	2	1	3+2	2	3	2	OTG	2	1					0/0	3(16)	2	LQFP64
	GD32F403RET6	168	512K	96K	up to 51	8	2		2	2	1	3+2	2	3	2	OTG	2	1					0/0	3(16)	2	LQFP64
	GD32F403RGT6	168	1024K	128K	up to 51	8	2		2	2	1	3+2	2	3	2	OTG	2	1					0/0	3(16)	2	LQFP64
	GD32F403RIT6	168	2048K	128K	up to 51	8	2		2	2	1	3+2	2	3	2	OTG	2	1					0/0	3(16)	2	LQFP64
	GD32F403RKT6	168	3072K	128K	up to 51	8	2		2	2	1	3+2	2	3	2	OTG	2	1					0/0	3(16)	2	LQFP64
	GD32F403VCT6	168	256K	64K	up to 80	8	2		2	2	1	3+2	2	3	2	OTG	2	1					1/0	3(16)	2	LQFP100
	GD32F403VET6	168	512K	96K	up to 80	8	2		2	2	1	3+2	2	3	2	OTG	2	1					1/0	3(16)	2	LQFP100
	GD32F403VGT6	168	1024K	128K	up to 80	8	2		2	2	1	3+2	2	3	2	OTG	2	1					1/0	3(16)	2	LQFP100
	GD32F403VIT6	168	2048K	128K	up to 80	8	2		2	2	1	3+2	2	3	2	OTG	2	1					1/0	3(16)	2	LQFP100
	GD32F403VKT6	168	3072K	128K	up to 80	8	2		2	2	1	3+2	2	3	2	OTG	2	1					1/0	3(16)	2	LQFP100
	GD32F403VCH6	168	256K	64K	up to 80	8	2		2	2	1	3+2	2	3	2	OTG	2	1					1/0	3(16)	2	BGA100
	GD32F403VEH6	168	512K	96K	up to 80	8	2		2	2	1	3+2	2	3	2	OTG	2	1					1/0	3(16)	2	BGA100
	GD32F403VGH6	168	1024K	128K	up to 80	8	2		2	2	1	3+2	2	3	2	OTG	2	1					1/0	3(16)	2	BGA100
	GD32F403VIH6	168	2048K	128K	up to 80	8	2		2	2	1	3+2	2	3	2	OTG	2	1					1/0	3(16)	2	BGA100
	GD32F403VKH6	168	3072K	128K	up to 80	8	2		2	2	1	3+2	2	3	2	OTG	2	1					1/0	3(16)	2	BGA100
	GD32F403ZCT6	168	256K	64K	up to 112	8	2		2	2	1	3+2	2	3	2	OTG	2	1					1/0	3(21)	2	LQFP144
GD32F403ZET6	168	512K	96K	up to 112	8	2		2	2	1	3+2	2	3	2	OTG	2	1					1/0	3(21)	2	LQFP144	
GD32F403ZGT6	168	1024K	128K	up to 112	8	2		2	2	1	3+2	2	3	2	OTG	2	1					1/0	3(21)	2	LQFP144	
GD32F403ZIT6	168	2048K	128K	up to 112	8	2		2	2	1	3+2	2	3	2	OTG	2	1					1/0	3(21)	2	LQFP144	
GD32F403ZKT6	168	3072K	128K	up to 112	8	2		2	2	1	3+2	2	3	2	OTG	2	1					1/0	3(21)	2	LQFP144	
GD32F405	GD32F405RET6	168	512K	192K	up to 51	8	2	2	2	2	1	4+2	3	3	2	FS+HS	2	1		1				3(16)	2	LQFP64
	GD32F405RGT6	168	1024K	192K	up to 51	8	2	2	2	2	1	4+2	3	3	2	FS+HS	2	1		1				3(16)	2	LQFP64
	GD32F405RKT6	168	3072K	192K	up to 51	8	2	2	2	2	1	4+2	3	3	2	FS+HS	2	1		1				3(16)	2	LQFP64
	GD32F405VGT6	168	1024K	192K	up to 82	8	2	2	2	2	1	4+2	3	3	2	FS+HS	2	1		1				3(16)	2	LQFP100
	GD32F405VKT6	168	3072K	192K	up to 82	8	2	2	2	2	1	4+2	3	3	2	FS+HS	2	1		1				3(16)	2	LQFP100
	GD32F405VGH6	168	1024K	192K	up to 82	8	2	2	2	2	1	4+2	3	3	2	FS+HS	2	1		1				3(16)	2	BGA100
	GD32F405VKH6	168	3072K	192K	up to 82	8	2	2	2	2	1	4+2	3	3	2	FS+HS	2	1		1				3(16)	2	BGA100
	GD32F405ZGT6	168	1024K	192K	up to 114	8	2	2	2	2	1	4+2	3	3	2	FS+HS	2	1		1				3(24)	2	LQFP144
GD32F405ZKT6	168	3072K	192K	up to 114	8	2	2	2	2	1	4+2	3	3	2	FS+HS	2	1		1				3(24)	2	LQFP144	
GD32F407	GD32F407RET6	168	512K	192K	up to 51	8	2	2	2	2	1	4+2	3	3	2	FS+HS	2	1		1	1			3(16)	2	LQFP64
	GD32F407RGT6	168	1024K	192K	up to 51	8	2	2	2	2	1	4+2	3	3	2	FS+HS	2	1		1	1			3(16)	2	LQFP64
	GD32F407RKT6	168	3072K	192K	up to 51	8	2	2	2	2	1	4+2	3	3	2	FS+HS	2	1		1	1			3(16)	2	LQFP64
	GD32F407VET6	168	512K	192K	up to 82	8	2	2	2	2	1	4+2	3	3	2	FS+HS	2	1		1	1		1/0	3(16)	2	LQFP100
	GD32F407VGT6	168	1024K	192K	up to 82	8	2	2	2	2	1	4+2	3	3	2	FS+HS	2	1		1	1		1/0	3(16)	2	LQFP100
	GD32F407VKT6	168	3072K	192K	up to 82	8	2	2	2	2	1	4+2	3	3	2	FS+HS	2	1		1	1		1/0	3(16)	2	LQFP100
	GD32F407VEH6	168	512K	192K	up to 82	8	2	2	2	2	1	4+2	3	3	2	FS+HS	2	1		1	1		1/0	3(16)	2	BGA100
	GD32F407VGH6	168	1024K	192K	up to 82	8	2	2	2	2	1	4+2	3	3	2	FS+HS	2	1		1	1		1/0	3(16)	2	BGA100
	GD32F407VKH6	168	3072K	192K	up to 82	8	2	2	2	2	1	4+2	3	3	2	FS+HS	2	1		1	1		1/0	3(16)	2	BGA100
	GD32F407ZET6	168	512K	192K	up to 114	8	2	2	2	2	1	4+2	3	3	2	FS+HS	2	1		1	1		1/1	3(24)	2	LQFP144
	GD32F407ZGT6	168	1024K	192K	up to 114	8	2	2	2	2	1	4+2	3	3	2	FS+HS	2	1		1	1		1/1	3(24)	2	LQFP144
	GD32F407ZKT6	168	3072K	192K	up to 114	8	2	2	2	2	1	4+2	3	3	2	FS+HS	2	1		1	1		1/1	3(24)	2	LQFP144
GD32F407IEH6	168	512K	192K	up to 140	8	2	2	2	2	1	4+2	3	3	2	FS+HS	2	1		1	1		1/1	3(24)	2	BGA176	
GD32F407IGH6	168	1024K	192K	up to 140	8	2	2	2	2	1	4+2	3	3	2	FS+HS	2	1		1	1		1/1	3(24)	2	BGA176	
GD32F407IKH6	168	3072K	192K	up to 140	8	2	2	2	2	1	4+2	3	3	2	FS+HS	2	1		1	1		1/1	3(24)	2	BGA176	
GD32F450	GD32F450VET6	200	512K	256K	up to 82	8	2	2	2	2	1	4+4	3	5	2	FS+HS	2	1	1	1	1	1	1/0	3(16)	2	LQFP100
	GD32F450VGT6	200	1024K	256K	up to 82	8	2	2	2	2	1	4+4	3	5	2	FS+HS	2	1	1	1	1	1	1/0	3(16)	2	LQFP100
	GD32F450VIT6	200	2048K	512K	up to 82	8	2	2	2	2	1	4+4	3	5	2	FS+HS	2	1	1	1	1	1	1/0	3(16)	2	LQFP100
	GD32F450VKT6	200	3072K	256K	up to 82	8	2	2	2	2	1	4+4	3	5	2	FS+HS	2	1	1	1	1	1	1/0	3(16)	2	LQFP100
	GD32F450ZET6	200	512K	256K	up to 114	8	2	2	2	2	1	4+4	3	6	2	FS+HS	2	1	1	1	1	1	1/1	3(24)	2	LQFP144
	GD32F450ZGT6	200	1024K	256K	up to 114	8	2	2	2	2	1	4+4	3	6	2	FS+HS	2	1	1	1	1	1	1/1	3(24)	2	LQFP144
	GD32F450ZIT6	200	2048K	512K	up to 114	8	2	2	2	2	1	4+4	3	6	2	FS+HS	2	1	1	1	1	1	1/1	3(24)	2	LQFP144
	GD32F450ZKT6	200	3072K	256K	up to 114	8	2	2	2	2	1	4+4	3	6	2	FS+HS	2	1	1	1	1	1	1/1	3(24)	2	LQFP144
	GD32F450IGH6	200	1024K	256K	up to 140	8	2	2	2	2	1	4+4	3	6	2	FS+HS	2	1	1	1	1	1	1/1	3(24)	2	BGA176
	GD32F450IIH6	200	2048K	512K	up to 140	8	2	2	2	2	1	4+4	3	6	2	FS+HS	2	1	1	1	1	1	1/1	3(24)	2	BGA176
GD32F450IKH6	200	3072K	256K	up to 140	8	2	2	2	2	1	4+4	3	6	2	FS+HS	2	1	1	1	1	1	1/1	3(24)	2	BGA176	

GD32F3 series of 32-bit ARM® Cortex®-M4 MCUs Selection Guide



Series	Part No.	Max Speed (MHz)	Memory (Bytes)		I/O	Timer						Connectivity						EXMC	Analog Interface		Package			
			Flash	SRAM		GPTM (16bit)	Advanced TM (16bit)	Basic TM (16bit)	SysTick (24bit)	WDG	RTC	USART +UART	I ² C	SPI	CAN 2.0B	USB 2.0 FS	I ² S		SDIO	Ethernet		12bit ADC Units (CHs)	12bit DAC Units	
GD32F303	GD32F303CBT6	120	128K	32K	up to 37	4	1	2	1	2	1	3	2	3	1	1	2				3(10)	2	LQFP48	
	GD32F303CCT6	120	256K	48K	up to 37	4	1	2	1	2	1	3	2	3	1	1	2				3(10)	2	LQFP48	
	GD32F303CET6	120	512K	64K	up to 37	4	1	2	1	2	1	3	2	3	1	1	2				3(10)	2	LQFP48	
	GD32F303CGT6	120	1024K	96K	up to 37	10	1	2	1	2	1	3	2	3	1	1	2				3(10)	2	LQFP48	
	GD32F303RBT6	120	128K	32K	up to 51	4	2	2	1	2	1	5	2	3	1	1	2				3(16)	2	LQFP64	
	GD32F303RCT6	120	256K	48K	up to 51	4	2	2	1	2	1	5	2	3	1	1	2	1				3(16)	2	LQFP64
	GD32F303RET6	120	512K	64K	up to 51	4	2	2	1	2	1	5	2	3	1	1	2	1				3(16)	2	LQFP64
	GD32F303RGT6	120	1024K	96K	up to 51	10	2	2	1	2	1	5	2	3	1	1	2	1				3(16)	2	LQFP64
	GD32F303RIT6	120	2048K	96K	up to 51	10	2	2	1	2	1	5	2	3	1	1	2	1				3(16)	2	LQFP64
	GD32F303RKT6	120	3072K	96K	up to 51	10	2	2	1	2	1	5	2	3	1	1	2	1				3(16)	2	LQFP64
	GD32F303VBT6	120	128K	32K	up to 80	4	2	2	1	2	1	5	2	3	1	1	2			•	3(16)	2	LQFP100	
	GD32F303VCT6	120	256K	48K	up to 80	4	2	2	1	2	1	5	2	3	1	1	2	1		•	3(16)	2	LQFP100	
	GD32F303VET6	120	512K	64K	up to 80	4	2	2	1	2	1	5	2	3	1	1	2	1		•	3(16)	2	LQFP100	
	GD32F303VGT6	120	1024K	96K	up to 80	10	2	2	1	2	1	5	2	3	1	1	2	1		•	3(16)	2	LQFP100	
	GD32F303VIT6	120	2048K	96K	up to 80	10	2	2	1	2	1	5	2	3	1	1	2	1		•	3(16)	2	LQFP100	
	GD32F303VKT6	120	3072K	96K	up to 80	10	2	2	1	2	1	5	2	3	1	1	2	1		•	3(16)	2	LQFP100	
	GD32F303ZCT6	120	256K	48K	up to 112	4	2	2	1	2	1	5	2	3	1	1	2	1		•	3(21)	2	LQFP144	
	GD32F303ZET6	120	512K	64K	up to 112	4	2	2	1	2	1	5	2	3	1	1	2	1		•	3(21)	2	LQFP144	
	GD32F303ZGT6	120	1024K	96K	up to 112	10	2	2	1	2	1	5	2	3	1	1	2	1		•	3(21)	2	LQFP144	
GD32F303ZIT6	120	2048K	96K	up to 112	10	2	2	1	2	1	5	2	3	1	1	2	1		•	3(21)	2	LQFP144		
GD32F303ZKT6	120	3072K	96K	up to 112	10	2	2	1	2	1	5	2	3	1	1	2	1		•	3(21)	2	LQFP144		
GD32F305	GD32F305RBT6	120	128K	64K	up to 51	4	1	2	1	2	1	5	2	3	2	OTG	2				2(16)	2	LQFP64	
	GD32F305RCT6	120	256K	96K	up to 51	4	1	2	1	2	1	5	2	3	2	OTG	2				2(16)	2	LQFP64	
	GD32F305RET6	120	512K	96K	up to 51	4	2	2	1	2	1	5	2	3	2	OTG	2				2(16)	2	LQFP64	
	GD32F305RGT6	120	1024K	96K	up to 51	10	2	2	1	2	1	5	2	3	2	OTG	2				2(16)	2	LQFP64	
	GD32F305VCT6	120	256K	96K	up to 80	4	1	2	1	2	1	5	2	3	2	OTG	2			•	2(16)	2	LQFP100	
	GD32F305VET6	120	512K	96K	up to 80	4	2	2	1	2	1	5	2	3	2	OTG	2			•	2(16)	2	LQFP100	
	GD32F305VGT6	120	1024K	96K	up to 80	10	2	2	1	2	1	5	2	3	2	OTG	2			•	2(16)	2	LQFP100	
	GD32F305ZCT6	120	256K	96K	up to 112	4	2	2	1	2	1	5	2	3	2	OTG	2			•	2(16)	2	LQFP144	
	GD32F305ZET6	120	512K	96K	up to 112	4	2	2	1	2	1	5	2	3	2	OTG	2			•	2(16)	2	LQFP144	
GD32F305ZGT6	120	1024K	96K	up to 112	10	2	2	1	2	1	5	2	3	2	OTG	2			•	2(16)	2	LQFP144		
GD32F307	GD32F307RCT6	120	256K	96K	up to 51	4	1	2	1	2	1	5	2	3	2	OTG	2			•	2(16)	2	LQFP64	
	GD32F307RET6	120	512K	96K	up to 51	4	2	2	1	2	1	5	2	3	2	OTG	2			•	2(16)	2	LQFP64	
	GD32F307RGT6	120	1024K	96K	up to 51	10	2	2	1	2	1	5	2	3	2	OTG	2			•	2(16)	2	LQFP64	
	GD32F307VCT6	120	256K	96K	up to 80	4	1	2	1	2	1	5	2	3	2	OTG	2			•	2(16)	2	LQFP100	
	GD32F307VET6	120	512K	96K	up to 80	4	2	2	1	2	1	5	2	3	2	OTG	2			•	2(16)	2	LQFP100	
	GD32F307VGT6	120	1024K	96K	up to 80	10	2	2	1	2	1	5	2	3	2	OTG	2			•	2(16)	2	LQFP100	
	GD32F307ZCT6	120	256K	96K	up to 112	4	2	2	1	2	1	5	2	3	2	OTG	2			•	2(16)	2	LQFP144	
	GD32F307ZET6	120	512K	96K	up to 112	4	2	2	1	2	1	5	2	3	2	OTG	2			•	2(16)	2	LQFP144	
GD32F307ZGT6	120	1024K	96K	up to 112	10	2	2	1	2	1	5	2	3	2	OTG	2			•	2(16)	2	LQFP144		

Series	Part No.	Max Speed (MHz)	Memory (Bytes)		I/O	Timer						Connectivity						Analog Interface		Package			
			Flash	SRAM		GPTM (32bit)	GPTM (16bit)	Advanced TM (16bit)	Basic TM (16bit)	SysTick (24bit)	WDG	RTC	USART	I ² C	SPI	USB 2.0 FS	I ² S	CEC	Comp		12bit ADC Units (CHs)	12bit DAC Units	
GD32F310	GD32F310F4P6TR	72	16K	4K	up to 15		4	1		1	2	1	1	1	1				1(9)		TSSOP20		
	GD32F310F6P6TR	72	32K	6K	up to 15		4	1		1	2	1	2	1	1				1(9)		TSSOP20		
	GD32F310F8P6TR	72	64K	8K	up to 15		4	1		1	2	1	2	2	2				1(9)		TSSOP20		
	GD32F310G8U6TR	72	64K	8K	up to 23		5	1		1	2	1	2	2	2				1(10)		QFN28		
	GD32F310K8U6	72	64K	8K	up to 27		5	1		1	2	1	2	2	2				1(10)		QFN32		
	GD32F310K6T6	72	32K	6K	up to 25		4	1		1	2	1	2	1	1				1(10)		LQFP32		
	GD32F310K8T6	72	64K	8K	up to 25		5	1		1	2	1	2	2	2				1(10)		LQFP32		
	GD32F310C8T6	72	64K	8K	up to 39		5	1		1	2	1	2	2	2				1(10)		LQFP48		
GD32F330	GD32F330F4P6TR	84	16K	4K	up to 15	1	4	1		1	2	1	1	1	1				1(9)		TSSOP20		
	GD32F330F6P6TR	84	32K	4K	up to 15	1	4	1		1	2	1	2	1	1				1(9)		TSSOP20		
	GD32F330F8P6TR	84	64K	8K	up to 15	1	4	1		1	2	1	2	2	2				1(9)		TSSOP20		
	GD32F330G4U6TR	84	16K	4K	up to 23	1	4	1		1	2	1	1	1	1				1(10)		QFN28		
	GD32F330G6U6TR	84	32K	4K	up to 23	1	4	1		1	2	1	2	1	1				1(10)		QFN28		
	GD32F330G8U6TR	84	64K	8K	up to 23	1	5	1		1	2	1	2	2	2				1(10)		QFN28		
	GD32F330K4U6	84	16K	4K	up to 27	1	4	1		1	2	1	1	1	1				1(10)		QFN32		
	GD32F330K6U6	84	32K	4K	up to 27	1	4	1		1	2	1	2	1	1				1(10)		QFN32		
	GD32F330K8U6	84	64K	8K	up to 27	1	5	1		1	2	1	2	2	2				1(10)		QFN32		
	GD32F330K4T6	84	16K	4K	up to 27	1	4	1		1	2	1	1	1	1				1(10)		LQFP32		
	GD32F330K6T6	84	32K	4K	up to 27	1	4	1		1	2	1	2	1	1				1(10)		LQFP32		
	GD32F330K8T6	84	64K	8K	up to 27	1	5	1		1	2	1	2	2	2				1(10)		LQFP32		
	GD32F330C4T6	84	16K	4K	up to 39	1	4	1		1	2	1	1	1	1				1(10)		LQFP48		
	GD32F330C6T6	84	32K	4K	up to 39	1	4	1		1	2	1	2	1	1				1(10)		LQFP48		
	GD32F330C8T6	84	64K	8K	up to 39	1	5	1		1	2	1	2	2	2				1(10)		LQFP48		
	GD32F330CBT6	84	128K	16K	up to 39	1	5	1		1	2	1	2	2	2				1(10)		LQFP48		
	GD32F330R8T6	84	64K	16K	up to 55	1	5	1		1	2	1	2	2	2				1(16)		LQFP64		
	GD32F330RBT6	84	128K	16K	up to 55	1	5	1		1	2	1	2	2	2				1(16)		LQFP64		
	GD32F350	GD32F350G4U6TR	108	16K	4K	up to 24	1	5	1	1	1	2	1	1	1	1	OTG	1	1	2	1(10)	1	QFN28
		GD32F350G6U6TR	108	32K	6K	up to 24	1	5	1	1	1	2	1	2	1	1	OTG	1	1	2	1(10)	1	QFN28
GD32F350G8U6TR		108	64K	8K	up to 24	1	5	1	1	1	2	1	2	2	2	OTG	1	1	2	1(10)	1	QFN28	
GD32F350K4U6		108	16K	4K	up to 27	1	5	1	1	1	2	1	1	1	1	OTG	1	1	2	1(10)	1	QFN32	
GD32F350K6U6		108	32K	6K	up to 27	1	5	1	1	1	2	1	2	1	1	OTG	1	1	2	1(10)	1	QFN32	
GD32F350K8U6		108	64K	8K	up to 27	1	5	1	1	1	2	1	2	2	2	OTG	1	1	2	1(10)	1	QFN32	
GD32F350C4T6		108	16K	4K	up to 39	1	5	1	1	1	2	1	1	1	1	OTG	1	1	2	1(10)	1	LQFP48	
GD32F350C6T6		108	32K	6K	up to 39	1	5	1	1	1	2	1	2	1	1	OTG	1	1	2	1(10)	1	LQFP48	
GD32F350C8T6		108	64K	8K	up to 39	1	5	1	1	1	2	1	2	2	2	OTG	1	1	2	1(10)	1	LQFP48	
GD32F350CBT6		108	128K	16K	up to 39	1	5	1	1	1	2	1	2	2	2	OTG	1	1	2	1(10)	1	LQFP48	
GD32F350R4T6		108	16K	4K	up to 55	1	5	1	1	1	2	1	1	1	1	OTG	1	1	2	1(16)	1	LQFP64	
GD32F350R6T6		108	32K	8K	up to 55	1	5	1	1	1	2	1	2	1	1	OTG	1	1	2	1(16)	1	LQFP64	
GD32F350R8T6	108	64K	16K	up to 55	1	5	1	1	1	2	1	2	2	2	OTG	1	1	2	1(16)	1	LQFP64		
GD32F350RBT6	108	128K	16K	up to 55	1	5	1	1	1	2	1	2	2	2	OTG	1	1	2	1(16)	1	LQFP64		

GD32F2 series of 32-bit ARM® Cortex®-M3 MCUs Selection Guide



Series	Part No.	Max Speed (MHz)	Memory (Bytes)		I/O	Timer						Connectivity										EXMC/SDRAM	Analog Interface		Package				
			Flash	SRAM		GPTM (16bit)	Adv TM (16bit)	Bsc TM (16bit)	SysTick (24bit)	WDG	RTC	USART +UART	I ² C	SPI	CAN 2.0B	USB 2.0 FS	I ² S	SDIO	LCD-TFT	Camera	ETH MAC		Crypto/Hash	12bit ADC Units (CHs)		12bit DAC Units			
GD32F205	GD32F205RCT6	120	256K	128K	up to 51	10	2	2	1	2	1	4+2	3	3	2	OTG	2	1									3(16)	2	LQFP64
	GD32F205RET6	120	512K	128K	up to 51	10	2	2	1	2	1	4+2	3	3	2	OTG	2	1									3(16)	2	LQFP64
	GD32F205RGT6	120	1024K	256K	up to 51	10	2	2	1	2	1	4+2	3	3	2	OTG	2	1									3(16)	2	LQFP64
	GD32F205RKT6	120	3072K	256K	up to 51	10	2	2	1	2	1	4+2	3	3	2	OTG	2	1									3(16)	2	LQFP64
	GD32F205VCT6	120	256K	128K	up to 82	10	2	2	1	2	1	4+4	3	3	2	OTG	2	1	1						1/0	3(16)	2	LQFP100	
	GD32F205VET6	120	512K	128K	up to 82	10	2	2	1	2	1	4+4	3	3	2	OTG	2	1	1						1/0	3(16)	2	LQFP100	
	GD32F205VGT6	120	1024K	256K	up to 82	10	2	2	1	2	1	4+4	3	3	2	OTG	2	1	1						1/0	3(16)	2	LQFP100	
	GD32F205VKT6	120	3072K	256K	up to 82	10	2	2	1	2	1	4+4	3	3	2	OTG	2	1	1						1/0	3(16)	2	LQFP100	
	GD32F205ZCT6	120	256K	128K	up to 114	10	2	2	1	2	1	4+4	3	3	2	OTG	2	1	1						1/1	3(24)	2	LQFP144	
	GD32F205ZET6	120	512K	128K	up to 114	10	2	2	1	2	1	4+4	3	3	2	OTG	2	1	1						1/1	3(24)	2	LQFP144	
	GD32F205ZGT6	120	1024K	256K	up to 114	10	2	2	1	2	1	4+4	3	3	2	OTG	2	1	1						1/1	3(24)	2	LQFP144	
	GD32F205ZKT6	120	3072K	256K	up to 114	10	2	2	1	2	1	4+4	3	3	2	OTG	2	1	1						1/1	3(24)	2	LQFP144	
GD32F207	GD32F207RCT6	120	256K	128K	up to 51	10	2	2	1	2	1	4+2	3	3	2	OTG	2	1		1	1	1				3(16)	2	LQFP64	
	GD32F207RET6	120	512K	128K	up to 51	10	2	2	1	2	1	4+2	3	3	2	OTG	2	1		1	1	1				3(16)	2	LQFP64	
	GD32F207RGT6	120	1024K	256K	up to 51	10	2	2	1	2	1	4+2	3	3	2	OTG	2	1		1	1	1				3(16)	2	LQFP64	
	GD32F207RKT6	120	3072K	256K	up to 51	10	2	2	1	2	1	4+2	3	3	2	OTG	2	1		1	1	1				3(16)	2	LQFP64	
	GD32F207VCT6	120	256K	128K	up to 82	10	2	2	1	2	1	4+4	3	3	2	OTG	2	1	1	1	1	1			1/0	3(16)	2	LQFP100	
	GD32F207VET6	120	512K	128K	up to 82	10	2	2	1	2	1	4+4	3	3	2	OTG	2	1	1	1	1	1			1/0	3(16)	2	LQFP100	
	GD32F207VGT6	120	1024K	256K	up to 82	10	2	2	1	2	1	4+4	3	3	2	OTG	2	1	1	1	1	1			1/0	3(16)	2	LQFP100	
	GD32F207VKT6	120	3072K	256K	up to 82	10	2	2	1	2	1	4+4	3	3	2	OTG	2	1	1	1	1	1			1/0	3(16)	2	LQFP100	
	GD32F207ZCT6	120	256K	128K	up to 114	10	2	2	1	2	1	4+4	3	3	2	OTG	2	1	1	1	1	1			1/1	3(24)	2	LQFP144	
	GD32F207ZET6	120	512K	128K	up to 114	10	2	2	1	2	1	4+4	3	3	2	OTG	2	1	1	1	1	1			1/1	3(24)	2	LQFP144	
	GD32F207ZGT6	120	1024K	256K	up to 114	10	2	2	1	2	1	4+4	3	3	2	OTG	2	1	1	1	1	1			1/1	3(24)	2	LQFP144	
	GD32F207ZKT6	120	3072K	256K	up to 114	10	2	2	1	2	1	4+4	3	3	2	OTG	2	1	1	1	1	1			1/1	3(24)	2	LQFP144	
	GD32F207IET6	120	512K	128K	up to 140	10	2	2	1	2	1	4+4	3	3	2	OTG	2	1	1	1	1	1			1/1	3(24)	2	LQFP176	
	GD32F207IGT6	120	1024K	256K	up to 140	10	2	2	1	2	1	4+4	3	3	2	OTG	2	1	1	1	1	1			1/1	3(24)	2	LQFP176	
	GD32F207IKT6	120	3072K	256K	up to 140	10	2	2	1	2	1	4+4	3	3	2	OTG	2	1	1	1	1	1			1/1	3(24)	2	LQFP176	

GD32F1 series of 32-bit ARM® Cortex®-M3 MCUs Selection Guide



Series	Part No.	Max Speed (MHz)	Memory (Bytes)		I/O	Timer						Connectivity						EXMC	Analog Interface		Package			
			Flash	SRAM		GPTM (16bit)	Advanced TM (16bit)	Basic TM (16bit)	SysTick (24bit)	WDG	RTC	USART (UART)	I ² C	SPI	CAN 2.0B	USB 2.0 FS	I ² S		SDIO	Ethernet		12bit ADC Units (CHs)	12bit DAC Units	
GD32F101	GD32F101T4U6	56	16K	4K	up to 26	2			1	2	1	2	1	1								1(10)		QFN36
	GD32F101T6U6	56	32K	6K	up to 26	2			1	2	1	2	1	1								1(10)		QFN36
	GD32F101T8U6	56	64K	10K	up to 26	3			1	2	1	2	1	1								1(10)		QFN36
	GD32F101TBU6	56	128K	16K	up to 26	3			1	2	1	2	1	1								1(10)		QFN36
	GD32F101C4T6	56	16K	4K	up to 37	2			1	2	1	2	1	1								1(10)		LQFP48
	GD32F101C6T6	56	32K	6K	up to 37	2			1	2	1	2	1	1								1(10)		LQFP48
	GD32F101C8T6	56	64K	10K	up to 37	3			1	2	1	3	2	2								1(10)		LQFP48
	GD32F101CBT6	56	128K	16K	up to 37	3			1	2	1	3	2	2								1(10)		LQFP48
	GD32F101R4T6	56	16K	4K	up to 51	2			1	2	1	2	1	1								1(16)		LQFP64
	GD32F101R6T6	56	32K	6K	up to 51	2			1	2	1	2	1	1								1(16)		LQFP64
	GD32F101R8T6	56	64K	10K	up to 51	3			1	2	1	3	2	2								1(16)		LQFP64
	GD32F101RBT6	56	128K	16K	up to 51	3			1	2	1	3	2	2								1(16)		LQFP64
	GD32F101RCT6	56	256K	32K	up to 51	4		2	1	2	1	5	2	3								1(16)	2	LQFP64
	GD32F101RDT6	56	384K	48K	up to 51	4		2	1	2	1	5	2	3								1(16)	2	LQFP64
	GD32F101RET6	56	512K	48K	up to 51	4		2	1	2	1	5	2	3								1(16)	2	LQFP64
	GD32F101RFT6	56	768K	80K	up to 51	10		2	1	2	1	5	2	3								2(16)	2	LQFP64
	GD32F101RGT6	56	1024K	80K	up to 51	10		2	1	2	1	5	2	3								2(16)	2	LQFP64
	GD32F101RIT6	56	2048K	80K	up to 51	10		2	1	2	1	5	2	3								2(16)	2	LQFP64
	GD32F101RKT6	56	3072K	80K	up to 51	10		2	1	2	1	5	2	3								2(16)	2	LQFP64
	GD32F101V8T6	56	64K	10K	up to 80	3			1	2	1	3	2	2							•	1(16)		LQFP100
	GD32F101VBT6	56	128K	16K	up to 80	3			1	2	1	3	2	2							•	1(16)		LQFP100
	GD32F101VCT6	56	256K	32K	up to 80	4		2	1	2	1	5	2	3							•	1(16)	2	LQFP100
	GD32F101VDT6	56	384K	48K	up to 80	4		2	1	2	1	5	2	3							•	1(16)	2	LQFP100
	GD32F101VET6	56	512K	48K	up to 80	4		2	1	2	1	5	2	3							•	1(16)	2	LQFP100
	GD32F101VFT6	56	768K	80K	up to 80	10		2	1	2	1	5	2	3							•	2(16)	2	LQFP100
	GD32F101VGT6	56	1024K	80K	up to 80	10		2	1	2	1	5	2	3							•	2(16)	2	LQFP100
	GD32F101VIT6	56	2048K	80K	up to 80	10		2	1	2	1	5	2	3							•	2(16)	2	LQFP100
	GD32F101VKT6	56	3072K	80K	up to 80	10		2	1	2	1	5	2	3							•	2(16)	2	LQFP100
	GD32F101ZCT6	56	256K	32K	up to 112	4		2	1	2	1	5	2	3							•	1(16)	2	LQFP144
	GD32F101ZDT6	56	384K	48K	up to 112	4		2	1	2	1	5	2	3							•	1(16)	2	LQFP144
	GD32F101ZET6	56	512K	48K	up to 112	4		2	1	2	1	5	2	3							•	1(16)	2	LQFP144
	GD32F101ZFT6	56	768K	80K	up to 112	10		2	1	2	1	5	2	3							•	2(16)	2	LQFP144
GD32F101ZGT6	56	1024K	80K	up to 112	10		2	1	2	1	5	2	3							•	2(16)	2	LQFP144	
GD32F101ZIT6	56	2048K	80K	up to 112	10		2	1	2	1	5	2	3							•	2(16)	2	LQFP144	
GD32F101ZKT6	56	3072K	80K	up to 112	10		2	1	2	1	5	2	3							•	2(16)	2	LQFP144	

GD32F1 series of 32-bit ARM® Cortex®-M3 MCUs Selection Guide



Series	Part No.	Max Speed (MHz)	Memory (Bytes)		I/O	Timer						Connectivity						EXMC	Analog Interface		Package		
			Flash	SRAM		GPTM (16bit)	Advanced TM (16bit)	Basic TM (16bit)	SysTick (24bit)	WDG	RTC	USART (UART)	I ² C	SPI	CAN 2.0B	USB 2.0 FS	I ² S		SDIO	Ethernet		12bit ADC Units (CHs)	12bit DAC Units
GD32F103	GD32F103T4U6	108	16K	6K	up to 26	2	1		1	2	1	2	1	1	1	1					2(10)		QFN36
	GD32F103T6U6	108	32K	10K	up to 26	2	1		1	2	1	2	1	1	1	1					2(10)		QFN36
	GD32F103T8U6	108	64K	20K	up to 26	3	1		1	2	1	2	1	1	1	1					2(10)		QFN36
	GD32F103TBU6	108	128K	20K	up to 26	3	1		1	2	1	2	1	1	1	1					2(10)		QFN36
	GD32F103C4T6	108	16K	6K	up to 37	2	1		1	2	1	2	1	1	1	1					2(10)		LQFP48
	GD32F103C6T6	108	32K	10K	up to 37	2	1		1	2	1	2	1	1	1	1					2(10)		LQFP48
	GD32F103C8T6	108	64K	20K	up to 37	3	1		1	2	1	3	2	2	1	1					2(10)		LQFP48
	GD32F103CBT6	108	128K	20K	up to 37	3	1		1	2	1	3	2	2	1	1					2(10)		LQFP48
	GD32F103R4T6	108	16K	6K	up to 51	2	1		1	2	1	2	1	1	1	1					2(16)		LQFP64
	GD32F103R6T6	108	32K	10K	up to 51	2	1		1	2	1	2	1	1	1	1					2(16)		LQFP64
	GD32F103R8T6	108	64K	20K	up to 51	3	1		1	2	1	3	2	2	1	1					2(16)		LQFP64
	GD32F103RBT6	108	128K	20K	up to 51	3	1		1	2	1	3	2	2	1	1					2(16)		LQFP64
	GD32F103RCT6	108	256K	48K	up to 51	4	2	2	1	2	1	5	2	3	1	1	2	1			3(16)	2	LQFP64
	GD32F103RDT6	108	384K	64K	up to 51	4	2	2	1	2	1	5	2	3	1	1	2	1			3(16)	2	LQFP64
	GD32F103RET6	108	512K	64K	up to 51	4	2	2	1	2	1	5	2	3	1	1	2	1			3(16)	2	LQFP64
	GD32F103RFT6	108	768K	96K	up to 51	10	2	2	1	2	1	5	2	3	1	1	2	1			3(16)	2	LQFP64
	GD32F103RGT6	108	1024K	96K	up to 51	10	2	2	1	2	1	5	2	3	1	1	2	1			3(16)	2	LQFP64
	GD32F103RIT6	108	2048K	96K	up to 51	10	2	2	1	2	1	5	2	3	1	1	2	1			3(16)	2	LQFP64
	GD32F103RKT6	108	3072K	96K	up to 51	10	2	2	1	2	1	5	2	3	1	1	2	1			3(16)	2	LQFP64
	GD32F103V8T6	108	64K	20K	up to 80	3	1		1	2	1	3	2	2	1	1				•	2(16)		LQFP100
	GD32F103VBT6	108	128K	20K	up to 80	3	1		1	2	1	3	2	2	1	1				•	2(16)		LQFP100
	GD32F103VCT6	108	256K	48K	up to 80	4	2	2	1	2	1	5	2	3	1	1	2	1		•	3(16)	2	LQFP100
	GD32F103VDT6	108	384K	64K	up to 80	4	2	2	1	2	1	5	2	3	1	1	2	1		•	3(16)	2	LQFP100
	GD32F103VET6	108	512K	64K	up to 80	4	2	2	1	2	1	5	2	3	1	1	2	1		•	3(16)	2	LQFP100
	GD32F103VFT6	108	768K	96K	up to 80	10	2	2	1	2	1	5	2	3	1	1	2	1		•	3(16)	2	LQFP100
	GD32F103VGT6	108	1024K	96K	up to 80	10	2	2	1	2	1	5	2	3	1	1	2	1		•	3(16)	2	LQFP100
	GD32F103VIT6	108	2048K	96K	up to 80	10	2	2	1	2	1	5	2	3	1	1	2	1		•	3(16)	2	LQFP100
	GD32F103VKT6	108	3072K	96K	up to 80	10	2	2	1	2	1	5	2	3	1	1	2	1		•	3(16)	2	LQFP100
	GD32F103ZCT6	108	256K	48K	up to 112	4	2	2	1	2	1	5	2	3	1	1	2	1		•	3(21)	2	LQFP144
	GD32F103ZDT6	108	384K	64K	up to 112	4	2	2	1	2	1	5	2	3	1	1	2	1		•	3(21)	2	LQFP144
	GD32F103ZET6	108	512K	64K	up to 112	4	2	2	1	2	1	5	2	3	1	1	2	1		•	3(21)	2	LQFP144
	GD32F103ZFT6	108	768K	96K	up to 112	10	2	2	1	2	1	5	2	3	1	1	2	1		•	3(21)	2	LQFP144
GD32F103ZGT6	108	1024K	96K	up to 112	10	2	2	1	2	1	5	2	3	1	1	2	1		•	3(21)	2	LQFP144	
GD32F103ZIT6	108	2048K	96K	up to 112	10	2	2	1	2	1	5	2	3	1	1	2	1		•	3(21)	2	LQFP144	
GD32F103ZKT6	108	3072K	96K	up to 112	10	2	2	1	2	1	5	2	3	1	1	2	1		•	3(21)	2	LQFP144	

GD32F1 series of 32-bit ARM® Cortex®-M3 MCUs Selection Guide



Series	Part No.	Max Speed (MHz)	Memory (Bytes)		I/O	Timer						Connectivity						EXMC	Analog Interface		Package			
			Flash	SRAM		GPTM (16bit)	Advanced TM (16bit)	Basic TM (16bit)	SysTick (24bit)	WDG	RTC	USART (UART)	I ² C	SPI	CAN 2.0B	USB 2.0 FS	I ² S		SDIO	Ethernet		12bit ADC Units (CHs)	12bit DAC Units	
GD32F105	GD32F105R8T6	108	64K	64K	up to 51	4	1	2	1	2	1	5	2	3	2	OTG	2				2(16)	2	LQFP64	
	GD32F105RBT6	108	128K	64K	up to 51	4	1	2	1	2	1	5	2	3	2	OTG	2				2(16)	2	LQFP64	
	GD32F105RCT6	108	256K	96K	up to 51	4	1	2	1	2	1	5	2	3	2	OTG	2				2(16)	2	LQFP64	
	GD32F105RDT6	108	384K	96K	up to 51	4	1	2	1	2	1	5	2	3	2	OTG	2				2(16)	2	LQFP64	
	GD32F105RET6	108	512K	96K	up to 51	4	1	2	1	2	1	5	2	3	2	OTG	2				2(16)	2	LQFP64	
	GD32F105RFT6	108	768K	96K	up to 51	4	1	2	1	2	1	5	2	3	2	OTG	2				2(16)	2	LQFP64	
	GD32F105RGT6	108	1024K	96K	up to 51	4	1	2	1	2	1	5	2	3	2	OTG	2				2(16)	2	LQFP64	
	GD32F105V8T6	108	64K	64K	up to 80	4	1	2	1	2	1	5	2	3	2	OTG	2			•	2(16)	2	LQFP100	
	GD32F105VBT6	108	128K	64K	up to 80	4	1	2	1	2	1	5	2	3	2	OTG	2			•	2(16)	2	LQFP100	
	GD32F105VCT6	108	256K	96K	up to 80	4	1	2	1	2	1	5	2	3	2	OTG	2			•	2(16)	2	LQFP100	
	GD32F105VDT6	108	384K	96K	up to 80	4	1	2	1	2	1	5	2	3	2	OTG	2			•	2(16)	2	LQFP100	
	GD32F105VET6	108	512K	96K	up to 80	4	1	2	1	2	1	5	2	3	2	OTG	2			•	2(16)	2	LQFP100	
	GD32F105VFT6	108	768K	96K	up to 80	4	1	2	1	2	1	5	2	3	2	OTG	2			•	2(16)	2	LQFP100	
	GD32F105VGT6	108	1024K	96K	up to 80	4	1	2	1	2	1	5	2	3	2	OTG	2			•	2(16)	2	LQFP100	
	GD32F105ZCT6	108	256K	96K	up to 112	4	1	2	1	2	1	5	2	3	2	OTG	2			•	2(16)	2	LQFP144	
	GD32F105ZDT6	108	384K	96K	up to 112	4	1	2	1	2	1	5	2	3	2	OTG	2			•	2(16)	2	LQFP144	
	GD32F105ZET6	108	512K	96K	up to 112	4	1	2	1	2	1	5	2	3	2	OTG	2			•	2(16)	2	LQFP144	
GD32F105ZFT6	108	768K	96K	up to 112	4	1	2	1	2	1	5	2	3	2	OTG	2			•	2(16)	2	LQFP144		
GD32F105ZGT6	108	1024K	96K	up to 112	4	1	2	1	2	1	5	2	3	2	OTG	2			•	2(16)	2	LQFP144		
GD32F107	GD32F107RBT6	108	128K	96K	up to 51	4	1	2	1	2	1	5	1	3	2	OTG	2			•	2(16)	2	LQFP64	
	GD32F107RCT6	108	256K	96K	up to 51	4	1	2	1	2	1	5	1	3	2	OTG	2			•	2(16)	2	LQFP64	
	GD32F107RDT6	108	384K	96K	up to 51	4	1	2	1	2	1	5	2	3	2	OTG	2			•	2(16)	2	LQFP64	
	GD32F107RET6	108	512K	96K	up to 51	4	1	2	1	2	1	5	2	3	2	OTG	2			•	2(16)	2	LQFP64	
	GD32F107RFT6	108	768K	96K	up to 51	4	1	2	1	2	1	5	2	3	2	OTG	2			•	2(16)	2	LQFP64	
	GD32F107RGT6	108	1024K	96K	up to 51	4	1	2	1	2	1	5	2	3	2	OTG	2			•	2(16)	2	LQFP64	
	GD32F107VBT6	108	128K	96K	up to 80	4	1	2	1	2	1	5	1	3	2	OTG	2			•	•	2(16)	2	LQFP100
	GD32F107VCT6	108	256K	96K	up to 80	4	1	2	1	2	1	5	1	3	2	OTG	2			•	•	2(16)	2	LQFP100
	GD32F107VDT6	108	384K	96K	up to 80	4	1	2	1	2	1	5	2	3	2	OTG	2			•	•	2(16)	2	LQFP100
	GD32F107VET6	108	512K	96K	up to 80	4	1	2	1	2	1	5	2	3	2	OTG	2			•	•	2(16)	2	LQFP100
	GD32F107VFT6	108	768K	96K	up to 80	4	1	2	1	2	1	5	2	3	2	OTG	2			•	•	2(16)	2	LQFP100
	GD32F107VGT6	108	1024K	96K	up to 80	4	1	2	1	2	1	5	2	3	2	OTG	2			•	•	2(16)	2	LQFP100
	GD32F107ZCT6	108	256K	96K	up to 112	4	1	2	1	2	1	5	2	3	2	OTG	2			•	•	2(16)	2	LQFP144
	GD32F107ZDT6	108	384K	96K	up to 112	4	1	2	1	2	1	5	2	3	2	OTG	2			•	•	2(16)	2	LQFP144
	GD32F107ZET6	108	512K	96K	up to 112	4	1	2	1	2	1	5	2	3	2	OTG	2			•	•	2(16)	2	LQFP144
GD32F107ZFT6	108	768K	96K	up to 112	4	1	2	1	2	1	5	2	3	2	OTG	2			•	•	2(16)	2	LQFP144	
GD32F107ZGT6	108	1024K	96K	up to 112	4	1	2	1	2	1	5	2	3	2	OTG	2			•	•	2(16)	2	LQFP144	

GD32F1 series of 32-bit ARM® Cortex®-M3 MCUs Selection Guide



Series	Part No.	Max Speed (MHz)	Memory (Bytes)		I/O	Timer						Connectivity					Analog Interface		Package		
			Flash	SRAM		GPTM (32bit)	GPTM (16bit)	Advanced TM (16bit)	Basic TM (16bit)	SysTick (24bit)	WDG	RTC	USART	I ² C	SPI	USB 2.0 FS	I ² S	CEC		12bit ADC Units (CHs)	12bit DAC Units
GD32F130	GD32F130F4P6TR	48	16K	4K	up to 15	1	4	1		1	2	1	1	1	1				1(9)		TSSOP20
	GD32F130F6P6TR	48	32K	4K	up to 15	1	4	1		1	2	1	2	1	1				1(9)		TSSOP20
	GD32F130F8P6TR	48	64K	8K	up to 15	1	4	1		1	2	1	2	2	2				1(9)		TSSOP20
	GD32F130G4U6TR	48	16K	4K	up to 23	1	4	1		1	2	1	1	1	1				1(10)		QFN28
	GD32F130G6U6TR	48	32K	4K	up to 23	1	4	1		1	2	1	2	1	1				1(10)		QFN28
	GD32F130G8U6TR	48	64K	8K	up to 23	1	5	1		1	2	1	2	2	2				1(10)		QFN28
	GD32F130K4T6	48	16K	4K	up to 27	1	4	1		1	2	1	1	1	1				1(10)		LQFP32
	GD32F130K6T6	48	32K	4K	up to 27	1	4	1		1	2	1	2	1	1				1(10)		LQFP32
	GD32F130K8T6	48	64K	8K	up to 27	1	5	1		1	2	1	2	2	2				1(10)		LQFP32
	GD32F130K4U6	48	16K	4K	up to 27	1	4	1		1	2	1	1	1	1				1(10)		QFN32
	GD32F130K6U6	48	32K	4K	up to 27	1	4	1		1	2	1	2	1	1				1(10)		QFN32
	GD32F130K8U6	48	64K	8K	up to 27	1	5	1		1	2	1	2	2	2				1(10)		QFN32
	GD32F130C4T6	48	16K	4K	up to 39	1	4	1		1	2	1	1	1	1				1(10)		LQFP48
	GD32F130C6T6	48	32K	4K	up to 39	1	4	1		1	2	1	2	1	1				1(10)		LQFP48
	GD32F130C8T6	48	64K	8K	up to 39	1	5	1		1	2	1	2	2	2				1(10)		LQFP48
GD32F130R8T6	48	64K	8K	up to 55	1	5	1		1	2	1	2	2	2				1(16)		LQFP64	
GD32F150	GD32F150G4U6TR	72	16K	4K	up to 24	1	5	1	1	1	2	1	1	1	1	1	1	1	1(10)	1	QFN28
	GD32F150G6U6TR	72	32K	6K	up to 24	1	5	1	1	1	2	1	2	1	1	1	1	1	1(10)	1	QFN28
	GD32F150G8U6TR	72	64K	8K	up to 24	1	5	1	1	1	2	1	2	2	2	1	1	1	1(10)	1	QFN28
	GD32F150K4U6	72	16K	4K	up to 27	1	5	1	1	1	2	1	1	1	1	1	1	1	1(10)	1	QFN32
	GD32F150K6U6	72	32K	6K	up to 27	1	5	1	1	1	2	1	2	1	1	1	1	1	1(10)	1	QFN32
	GD32F150K8U6	72	64K	8K	up to 27	1	5	1	1	1	2	1	2	2	2	1	1	1	1(10)	1	QFN32
	GD32F150C4T6	72	16K	4K	up to 39	1	5	1	1	1	2	1	1	1	1	1	1	1	1(10)	1	LQFP48
	GD32F150C6T6	72	32K	6K	up to 39	1	5	1	1	1	2	1	2	1	1	1	1	1	1(10)	1	LQFP48
	GD32F150C8T6	72	64K	8K	up to 39	1	5	1	1	1	2	1	2	2	2	1	1	1	1(10)	1	LQFP48
	GD32F150R4T6	72	16K	4K	up to 55	1	5	1	1	1	2	1	1	1	1	1	1	1	1(16)	1	LQFP64
	GD32F150R6T6	72	32K	6K	up to 55	1	5	1	1	1	2	1	2	1	1	1	1	1	1(16)	1	LQFP64
	GD32F150R8T6	72	64K	8K	up to 55	1	5	1	1	1	2	1	2	2	2	1	1	1	1(16)	1	LQFP64

GD30 PMU

Application Specific PMIC

- ◆ TWS earbuds charging case
- ◆ Headsets and hearing aids
- ◆ Portable medical equipment
- ◆ Patient monitors
- ◆ Low power applications

High Performance Power IC

- ◆ Wireless infrastructure
- ◆ Telecom/Networking cards
- ◆ Industrial application
- ◆ IPC
- ◆ Points of load

Motor Driver

- ◆ 3-Phase BLDC and PMSM Motors
- ◆ Power tools
- ◆ Robotics and RC toys
- ◆ Industrial automation

Battery Management

- ◆ Battery chargers and AFE
- ◆ Notebook
- ◆ Cleaning robots
- ◆ Aeromodel, drones
- ◆ Energy storage

GD30WS Power Management IC

Part No.	Absolute VUSB (V)	Control Topology	Charging Current (A)	Load Current (A)	Charging Efficiency (%)	CV Charge Voltage (V)	Quiescent Current (μA)	LDO	Control interface	12bit ADC	Protection Features						Operating Temperature Range	Package	MPQ (PCS)	MOQ (PCS)
	Max		Max	Max	Max						Max	Short Circuit	Over Voltage	Under Voltage	Over Current	Over Temperature				
GD30WS8805EU	20	Switch-Mode	1.2	0.6	95	4.1/4.2/4.3/4.35/4.4 @0.5%	<5	3.3V/50mA	I ² C	•	•	•	•	•	•	-20~85°C	QFN24	490	2940	
GD30WS8815EU	20	Switch-Mode	1.5	1	95	4.1/4.2/4.3/4.35/4.4 @0.5%	<5	3.3V/80mA	I ² C	•	•	•	•	•	•	-20~85°C	QFN24	490	2940	
GD30WS8855EU	20	Switch-Mode	1.2	0.6	95	4.1/4.2/4.3/4.35/4.4 @0.5%	<5	3.3V/50mA	I ² C	•	•	•	•	•	•	-20~85°C	QFN24	490	2940	

GD30DR Motor Driver

Part No.	Supply Voltage (V)		Gate Driver	Power MOSFET	Gate Driver Peak Current (A)		Control Interface	PWM Frequency (kHz)	Buck Controller	LDO	Protection Features			Operating Temperature Range	Package	MPQ (PCS)	MOQ (PCS)
	Min	Max			Source	Sink		Max			Under Voltage	Over Temperature	Fault diagnostics				
GD30DR8306KU	4.5	30	3	External	1	1.2	6xPWM, 3xPWM	200	5V/2A	5V/40mA	•	•	•	-40~105°C	QFN32	490	2940
GD30DR8304EUTR	4.5	30	3	External	1	1.2	6xPWM, 3xPWM	200	/	5V/40mA	•	•	•	-40~105°C	QFN24	3000	3000

Part No.	Supply Voltage (V)		Gate Driver	Power MOSFET	Drive Current (A)	Control Interface	PWM Frequency (kHz)	LDO	Protection Features	Operating Temperature Range	Package	MPQ (PCS)	MOQ (PCS)
	Min	Max					Max		Over Temperature				
GD30DR8413EUTR	4.5	30	-	Internal	3A	3xPWM	50	5V/20mA	•	-40~125°C	QFN24	3000	3000

GD30BC Battery Management

Part No.	Series Cells	Input Operation Voltage (V)		Control Topology	Charging Current (A)	Charging Efficiency (%)	CV Charge Voltage for Per cell (V)	LDO	Power Path	Control interface	Protection Features				Operating Temperature Range	Package	MPQ (PCS)	MOQ (PCS)
		Min	Max		Max	Max					Over Voltage	Under Voltage	Over Current	Battery Over/Under Temperature				
GD30BC2501LRTR	4,6	18	32	Buck	5	95	4.1/4.2/4.3/4.35@1%	3.3V/25mA	NO	I ² C	•	•	•	•	-40~85°C	QFN16	3000	3000
GD30BC2502LRTR	2,3,5	18	32	Buck	5	95	4.1/4.2/4.3/4.35@1%	3.3V/25mA	NO	I ² C	•	•	•	•	-40~85°C	QFN16	3000	3000
GD30BC2416FUTR	1	4.4	5.5	Buck(Charging)-Boost(Discharging)	1.5	97	4.1/4.2/4.3/4.35/4.4@0.5%	3.3V/50mA	YES	I ² C	•	•	•	-	-20~85°C	QFN20	3000	3000

Part No.	Absolute VUSB (V)	Control Topology	Charging Current (A)	Load Current (A)	CV Charge Voltage (V)	Quiescent Current (μA)	LDO	Control interface	Protection Features						Operating Temperature Range	Package	MPQ (PCS)	MOQ (PCS)
	Max								Short Circuit	Over Voltage	Under Voltage	Over Current	Over Temperature	Under Temperature				
GD30WS8662DYTR	35	Linear-Mode	8~456mA (8mA/step)	0.4~3.2A (0.2A/step)	3.6~4.545 (15mV/step) @0.5%	<0.4	3.3V/50mA	I ² C	•	•	•	•	•	•	-40~85°C	WLCSP9	3000	3000

Part No.	Input Operation Voltage (V)		MAX Output Current (A)	Over Voltage Protection (V)		Internal switch ON resistance (mΩ)	Quiescent Current (μA)	Protection Features			Operating Temperature Range	Package	MPQ (PCS)	MOQ (PCS)
	Min	Max		Min	Max			Over Current	Over Current	Over Temperature				
GD30SP2200WFTR	2.5	30	3	4	15	50	100	•	•	•	-40~85°C	DFN8L	3000	3000

GD30LD

High Accuracy, Low Noise LDO

Part No.	V _{IN} (V)		V _{OUT} (V)		Output Current (A)	Dropout Voltage @ with BIAS (mV)	PSRR (db)	Output Voltage Noise (μVRMS)		Ground Current (mA)	Protection Features			Operating Temperature Range	Package	MPQ (PCS)	MOQ (PCS)
	With BIAS	Without BIAS	Pin-selectable	Set by a Resistor Divider	Max			0.8V Output	5V Output		Current Limiting	Over Temperature	Power Good				
GD30LD3300FUTR	1.1~6.5	1.4~6.5	0.5~2.075	0.5~5.2	3	180	42@10kHz	5.9	9.8	3	•	•	•	-40~125°C	QFN20	3000	3000
GD30LD3301FUTR	1.1~6.5	1.4~6.5	0.8~3.95	0.8~5.2	3	180	42@10kHz	5.9	9.8	3	•	•	•	-40~125°C	QFN20	3000	3000
GD30LD3137WETR-I	1.1~6.5	1.4~6.5	-	0.8~5.5	1.2	75	40@500kHz	4.4	7.7	3	•	•	•	-40~125°C	DFN8	3000	3000

Part No.	V _{IN} (V)	V _{OUT} (V)		Output Current (A)	Dropout Voltage @2A (mV)	PSRR (db)	Ground Current (mA)	Protection Features			Operating Temperature Range	Package	MPQ (PCS)	MOQ (PCS)
		Pin-selectable	Set by a Resistor Divider	Max				Current Limiting	Over Temperature	Power Good				
GD30LD1000WGTR-I	1.4~6.5	-	0.5~5.2	2	180	39@ 500 KHz	3	•	•	•	-40~125°C	QFN20	3000	3000
GD30LD1001LUTR-I	1.4~6.5	0.5~2.075	0.5~5.2	2	180	39@ 500 KHz	3	•	•	•	-40~125°C	DFN8	3000	3000

GD30DC

General Purpose DC/DC Converter

Part No.	Topology	V _{IN} (V)	Output Current (Max)(A)	I _o (Typ) (uA)	Vfb(Typ) (V)	Fsw (MHz)	Control Mode	Light-Load Efficiency	Current Limit	Short Circuit Protection	100% Duty Cycle	Output Discharge	Power Good	Fixed V _{OUT} (V)	Operating Temperature Range	Package
GD30DC1100SOTR-N	BUCK	2.5~5.5	2	15	0.6	2	COT	•	•	•	•	•	-	-	-20~85°C	SOT563
GD30DC1100SOTR-N12	BUCK	2.5~5.5	2	15	0.6	2	COT	•	•	•	•	•	•	1.2	-20~85°C	SOT563
GD30DC1100SOTR-N15	BUCK	2.5~5.5	2	15	0.6	2	COT	•	•	•	•	•	•	1.5	-20~85°C	SOT563
GD30DC1100SOTR-N18	BUCK	2.5~5.5	2	15	0.6	2	COT	•	•	•	•	•	•	1.8	-20~85°C	SOT563
GD30DC1100SOTR-N25	BUCK	2.5~5.5	2	15	0.6	2	COT	•	•	•	•	•	•	2.5	-20~85°C	SOT563
GD30DC1100SOTR-N33	BUCK	2.5~5.5	2	15	0.6	2	COT	•	•	•	•	•	•	3.3	-20~85°C	SOT563
GD30DC1101NSTR-I	BUCK	2.5~6	1	40	0.6	1.5	Current Mode	•	•	•	•	•	-	-	-40~125°C	SOT23-5

Part No.	Topology	V _{IN} (V)	Ilimit (Typ)(A)	I _o (Typ) (uA)	Vout (V)	Vfb(Typ) (V)	Fsw (MHz)	Soft Start	Operating Temperature Range	Package
GD30DC2300SSTR-N	BOOST	2.5~20	3	10	0.6~30	0.6	1.2	•	-20~85°C	SOT23-6



SPI NOR Flash

GD SPI NOR Flash Features



3V

- ◆ **Single Power Supply Voltage** - Voltage range: 2.7V~3.6V
- ◆ **High Speed Clock Frequency** - Maximum 200MHz for fast read*
 - Dual I/O Data transfer up to 332Mbit/s
 - Quad I/O Data transfer up to 664Mbit/s
 - DTR Quad I/O Data transfer up to 1600Mbit/s
 - DTR Octal I/O Data transfer up to 3200Mbit/s
 - Continuous read with 8/16/32/64-Byte wrap
- ◆ **Flexible Memory Architecture**
 - Sector size: 4K Bytes
 - Block size: 32/64K Bytes

1.8V

- ◆ **Single Power Supply Voltage** - Voltage range: 1.65V~2.0V
- ◆ **High Speed Clock Frequency** - Maximum 200MHz for fast read*
 - Dual I/O Data transfer up to 332Mbit/s
 - Quad I/O Data transfer up to 664Mbit/s
 - QPI Data transfer up to 664Mbit/s
 - DTR Quad I/O Data transfer up to 1600Mbit/s
 - DTR Octal I/O Data transfer up to 3200Mbit/s
 - Continuous read with 8/16/32/64-Byte wrap
- ◆ **Flexible Memory Architecture**
 - Sector size: 4K Bytes
 - Block size: 32/64K Bytes

1.65V~3.6V

- ◆ **Single Power Supply Voltage** - Voltage range: 1.65V~3.6V
- ◆ **High Speed Clock Frequency** - Maximum 104MHz for fast read*
 - Dual I/O Data transfer up to 208Mbit/s
 - Quad I/O Data transfer up to 416Mbit/s
 - Continuous read with 8/16/32/64-Byte wrap
- ◆ **Flexible Memory Architecture**
 - Sector size: 4K Bytes
 - Block size: 32/64K Bytes

1.2V

- ◆ **Single Power Supply Voltage** - Voltage range: 1.14V~1.26V
- ◆ **High Speed Clock Frequency** - Maximum 120MHz for fast read*
 - Dual I/O Data transfer up to 240Mbit/s
 - Quad I/O Data transfer up to 480Mbit/s
 - QPI Data transfer up to 480Mbit/s
 - DTR Quad I/O Data transfer up to 480Mbit/s
 - Continuous read with 8/16/32/64-Byte wrap
- ◆ **Flexible Memory Architecture**
 - Sector size: 4K Bytes
 - Block size: 32/64K Bytes

* Please refer to page 22-25 for details.

GD SPI NOR Flash Part Number Definition

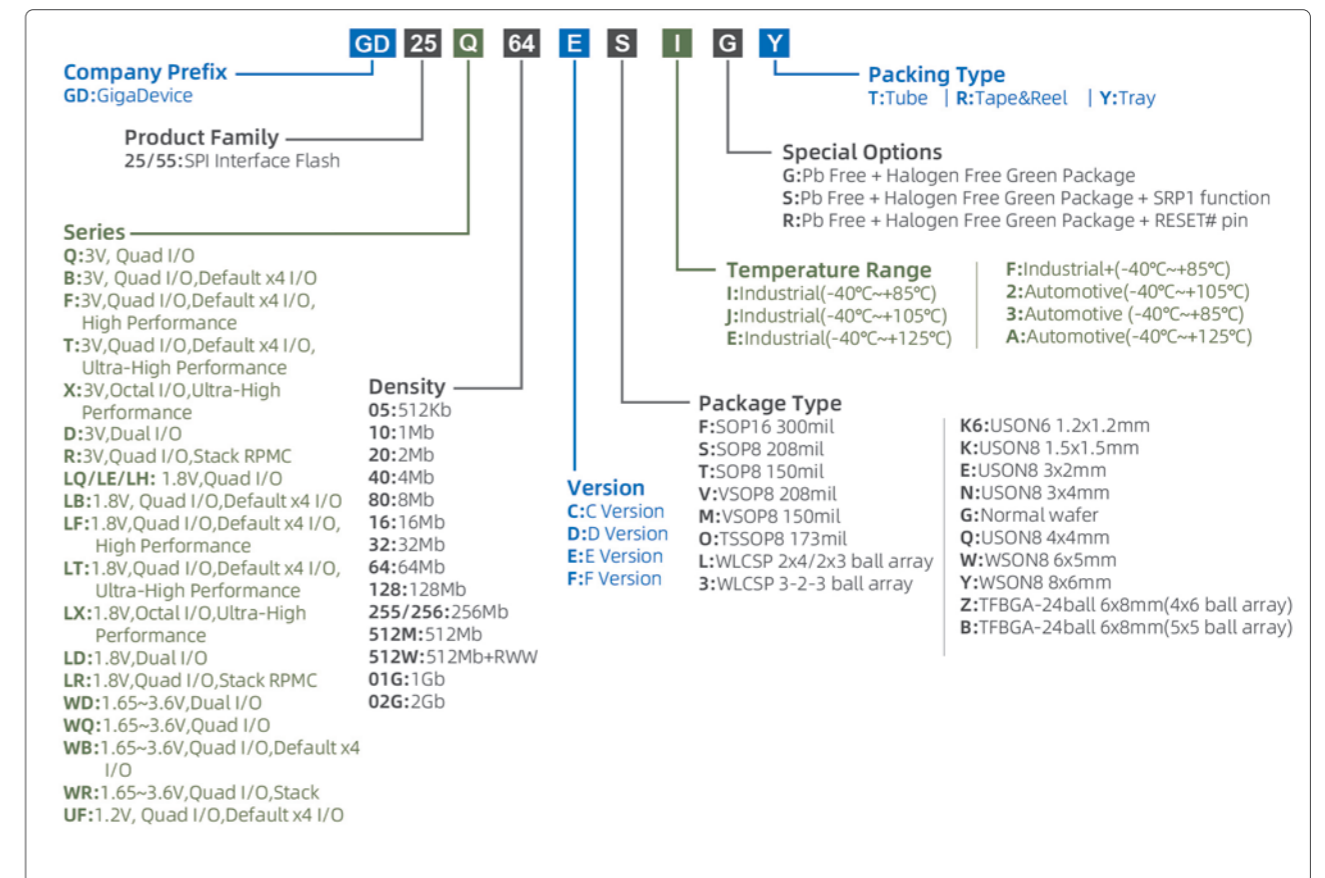

GD SPI NOR Flash Feature List

Flash Type	3V								1.8V								1.65V-3.6V				1.2V
	Q	B	F	X	T	R	D	LQ	LB	LF	LE	LX	LT	LR	LH	LD	WQ	WD	WB	WR	UF
Part No.	xxE	xxE xxF	xxF	xxE	xxE	xxE xxF	xxC xxE	xxD xxE	xxE xxF	xxE xxF	xxE	xxE	xxE	xxE xxF	xxE	xxC xxE	xxE	xxC xxE	xxE	xxE	xxE
Single I/O (1-1-1)
Dual Output (1-1-2)	.	*	.	.	.	*	.	.	*	*
Dual I/O (1-2-2)	.	*	.	.	.	*	.	.	*	*
Quad Output (1-1-4)
Quad I/O (1-4-4)
Octal Output (1-1-8)
Octal I/O (1-8-8)
QPI (4-4-4)	.	*	*	*	*	*
OPI (8-8-8)
H/W Reset (RESET# Pin)	*	*	.	.	.	*	.	*	*	*	*	.	.	*	.	.	*	.	*	*	*
S/W Reset
H/W Write Protection (WP# Pin)	.	*	*	.	.	*	.	.	*	.	.	.	*
S/W Write Protection
Volatile & Non-volatile Status Register Bit
Output Driver Strength	*	*	.	.	.	*	.	*	*	*	*	.	*	.	.	.	*	.	*	*	*
Security Registers with OTP Locks	*	*	.	*	.	.	.
SFDP Register
DTR	.	*	*
ECC

* This feature is supported by part of family.

GD SPI NOR Flash Product List

Part No.	Density	Voltage	Oragnization	I/O Bus	Frequency (MHz)	Package
GD25LD05C	512Kb	1.65V-2.0V	4KB / 32KB / 64KB	Single / Dual Output	50MHz(x1) 40MHz(x2)	SOP8 150mil USON8 1.5x1.5mm USON8 3x2mm
GD25LD10C	1Mb	1.65V-2.0V	4KB / 32KB / 64KB	Single / Dual Output	50MHz(x1) 40MHz(x2)	SOP8 150mil USON8 1.5x1.5mm USON8 3x2mm
GD25LQ20E	2Mb	1.65V-2.0V	4KB / 32KB / 64KB	Single / Dual / Quad	133MHz(x1, x2, x4)	SOP8 150mil USON8 1.5x1.5mm USON8 3x2mm
GD25LE20E	2Mb	1.65V-2.0V	4KB / 32KB / 64KB	Single / Dual / Quad	133MHz(x1, x2, x4)	SOP8 150mil USON8 1.5x1.5mm USON8 3x2mm
GD25LD20E	2Mb	1.65V-2.0V	4KB / 32KB / 64KB	Single / Dual Output	50MHz(x1) 40MHz(x2)	SOP8 150mil USON8 1.5x1.5mm USON8 3x2mm USON6 1.2x1.2mm
GD25LQ40E	4Mb	1.65V-2.0V	4KB / 32KB / 64KB	Single / Dual / Quad	133MHz(x1, x2, x4)	SOP8 150mil USON8 1.5x1.5mm USON8 3x2mm
GD25LE40E	4Mb	1.65V-2.0V	4KB / 32KB / 64KB	Single / Dual / Quad	133MHz(x1, x2, x4)	SOP8 150mil USON8 1.5x1.5mm USON8 3x2mm
GD25LD40E	4Mb	1.65V-2.0V	4KB / 32KB / 64KB	Single / Dual Output	50MHz(x1) 40MHz(x2)	SOP8 150mil USON8 1.5x1.5mm USON8 3x2mm USON6 1.2x1.2mm
GD25LH40E	4Mb	1.65V-2.0V	4KB / 32KB / 64KB	Single / Dual / Quad	133MHz(x1,x2,x4)	USON8 3x2mm USON8 1.5x1.5mm
GD25LE80E	8Mb	1.65V-2.0V	4KB / 32KB / 64KB	Single / Dual / Quad	133MHz(x1, x2, x4)	USON8 3x2mm WLCSP (4-4 ball array)
GD25LF80E	8Mb	1.65V-2.0V	4KB / 32KB / 64KB	Single / Dual / Quad	166MHz(x1, x2, x4) 104MHz(DTR)	SOP8 150mil SOP8 208mil USON8 3x2mm
GD25LH80E	8Mb	1.65V-2.0V	4KB / 32KB / 64KB	Single / Dual / Quad	133MHz(x1, x2, x4)	VSOP8 150mil USON8 3x2mm
GD25LQ80E	8Mb	1.65V-2.0V	4KB / 32KB / 64KB	Single / Dual / Quad	133MHz(x1, x2, x4)	SOP8 150mil SOP8 208mil USON8 3x2mm
GD25LD80E	8Mb	1.65V-2.0V	4KB / 32KB / 64KB	Single / Dual Output	50MHz(x1) 40MHz(x2)	SOP8 150mil SOP8 208mil USON8 1.5x1.5mm USON8 3x2mm
GD25LB16E	16Mb	1.65V-2.0V	4KB / 32KB / 64KB	Single / Dual / Quad	133MHz(x1, x2, x4)	SOP8 150mil SOP8 208mil USON8 3x2mm
GD25LE16E	16Mb	1.65V-2.0V	4KB / 32KB / 64KB	Single / Dual / Quad	133MHz(x1, x2, x4)	USON8 3x2mm WLCSP (3-2-3 ball array)
GD25LF16E	16Mb	1.65V-2.0V	4KB / 32KB / 64KB	Single / Dual / Quad	166MHz(x1, x2, x4) 104MHz(DTR)	SOP8 150mil SOP8 208mil USON8 3x2mm USON8 3x4mm
GD25LH16E	16Mb	1.65V-2.0V	4KB / 32KB / 64KB	Single / Dual / Quad	133MHz(x1, x2, x4)	SOP8 150mil SOP8 208mil USON8 3x2mm USON8 3x4mm
GD25LQ16E	16Mb	1.65V-2.0V	4KB / 32KB / 64KB	Single / Dual / Quad	133MHz(x1, x2, x4)	SOP8 150mil SOP8 208mil USON8 3x2mm USON8 3x4mm WLCSP (3-2-3 ball array)
GD25LB32E	32Mb	1.65V-2.0V	4KB / 32KB / 64KB	Single / Dual / Quad	133MHz(x1, x2, x4)	SOP8 150mil SOP8 208mil USON8 3x2mm USON8 3x4mm
GD25LE32E	32Mb	1.65V-2.0V	4KB / 32KB / 64KB	Single / Dual / Quad	133MHz(x1, x2, x4)	USON8 3x2mm USON8 3x4mm WLCSP (4-4 ball array) WLCSP 3-2-3 ball array
GD25LF32E	32Mb	1.65V-2.0V	4KB / 32KB / 64KB	Single / Dual / Quad	166MHz(x1, x2, x4) 104MHz(DTR)	SOP8 150mil SOP8 208mil USON8 3x2mm USON8 3x4mm
GD25LH32E	32Mb	1.65V-2.0V	4KB / 32KB / 64KB	Single / Dual / Quad	133MHz(x1, x2, x4)	SOP8 208mil USON8 3x2mm USON8 3x4mm
GD25LQ32E	32Mb	1.65V-2.0V	4KB / 32KB / 64KB	Single / Dual / Quad	133MHz(x1, x2, x4)	SOP8 150mil SOP8 208mil USON8 3x2mm USON8 3x4mm WLCSP (4-4 ball array)
GD25LB64E	64Mb	1.65V-2.0V	4KB / 32KB / 64KB	Single / Dual / Quad	133MHz(x1, x2, x4)	SOP8 150mil SOP8 208mil VSOP8 208mil USON8 3x4mm USON8 4x4mm WSON8 6x5mm
GD25LE64E	64Mb	1.65V-2.0V	4KB / 32KB / 64KB	Single / Dual / Quad	133MHz(x1, x2, x4)	SOP8 150mil SOP8 208mil USON8 3x4mm USON8 4x4mm WSON8 6x5mm WLCSP (4-4 ball array)
GD25LF64E	64Mb	1.65V-2.0V	4KB / 32KB / 64KB	Single / Dual / Quad	166MHz(x1, x2, x4) 104MHz(DTR)	SOP8 150mil SOP8 208mil USON8 3x4mm USON8 4x4mm WSON8 6x5mm
GD25LQ64E	64Mb	1.65V-2.0V	4KB / 32KB / 64KB	Single / Dual / Quad	133MHz(x1, x2, x4)	SOP8 150mil SOP8 208mil VSOP8 208mil USON8 3x4mm USON8 4x4mm WSON8 6x5mm WLCSP (4-4 ball array)
GD25LR64E	64Mb	1.65V-2.0V	4KB / 32KB / 64KB	Single / Dual / Quad	104MHz(x1, x2, x4)	SOP8 208mil WSON8 6x5mm
GD25LR128E	128Mb	1.65V-2.0V	4KB / 32KB / 64KB	Single / Dual / Quad	104MHz(x1, x2, x4)	SOP8 208mil WSON8 6x5mm WSON8 8x6mm
GD25LE128E	128Mb	1.65V-2.0V	4KB / 32KB / 64KB	Single / Dual / Quad	133MHz(x1, x2, x4)	SOP8 208mil USON8 4x4mm WSON8 6x5mm WSON8 8x6mm TFBGA24 8x6mm (5x5 ball array) WLCSP (4-4 ball array)
GD25LB128E	128Mb	1.65V-2.0V	4KB / 32KB / 64KB	Single / Dual / Quad	133MHz(x1, x2, x4)	SOP8 208mil SOP16 300mil USON8 4x4mm WSON8 6x5mm WSON8 8x6mm TFBGA24 8x6mm (5x5 ball array)
GD25LF128E	128Mb	1.65V-2.0V	4KB / 32KB / 64KB	Single / Dual / Quad	166MHz(x1, x2, x4) 104MHz(DTR)	SOP8 208mil USON8 4x4mm WSON8 6x5mm TFBGA24 8x6mm (5x5 ball array)
GD25LQ128E	128Mb	1.65V-2.0V	4KB / 32KB / 64KB	Single / Dual / Quad	120MHz(x1,x2,x4)	SOP8 208mil SOP16 300mil USON8 4x4mm WSON8 6x5mm WSON8 8x6mm TFBGA24 8x6mm (5x5 ball array)
GD25LE255E	256Mb	1.65V-2.0V	4KB / 32KB / 64KB	Single / Dual / Quad	133MHz(x1, x2, x4)	WSON8 6x5mm WLCSP (4-4 ball array)
GD25LF255E	256Mb	1.65V-2.0V	4KB / 32KB / 64KB	Single / Dual / Quad	166MHz(x1, x2, x4) 104MHz(DTR)	WSON8 6x5mm WLCSP (4-4 ball array)
GD25LQ255E	256Mb	1.65V-2.0V	4KB / 32KB / 64KB	Single / Dual / Quad	133MHz(x1, x2, x4)	SOP16 300mil WSON8 6x5mm WSON8 8x6mm TFBGA24 8x6mm (5x5 ball array) WLCSP (4-4 ball array)
GD25LB256E	256Mb	1.65V-2.0V	4KB / 32KB / 64KB	Single / Quad	166MHz(x1, x4) 104MHz(DTR)	SOP16 300mil WSON8 8x6mm TFBGA24 8x6mm (5x5 ball array) WLCSP (4-4 ball array) WLCSP (3-2-3 ball array)
GD25LR256E	256Mb	1.65V-2.0V	4KB / 32KB / 64KB	Single / Quad	104MHz(x1, x4) 60MHz(DTR)	SOP16 300mil WSON8 6x5mm WSON8 8x6mm
GD25LT256E	256Mb	1.65V-2.0V	4KB / 32KB / 64KB	Single / Quad	166MHz(x1, x4) 200MHz(DTR)	SOP16 300mil WSON8 8x6mm TFBGA24 8x6mm (5x5 ball array)
GD25LX256E	256Mb	1.65V-2.0V	4KB / 32KB / 64KB	Single / Octal	166MHz(x1, x8) 200MHz(DTR)	SOP16 300mil TFBGA24 8x6mm (5x5 ball array) WLCSP (4x6 ball array)
GD25LB256F	256Mb	1.65V-2.0V	4KB / 32KB / 64KB	Single / Dual / Quad	133MHz(x1, x2, x4)	SOP16 300mil WSON8 6x5mm WSON8 8x6mm TFBGA24 8x6mm(5x5 ball array) WLCSP (4-4 ball array)
GD25LF256F	256Mb	1.65V-2.0V	4KB / 32KB / 64KB	Single / Dual / Quad	166MHz(x1, x2, x4) 104MHz(DTR)	SOP16 300mil WSON8 6x5mm WSON8 8x6mm TFBGA24 8x6mm(5x5 ball array)
GD25LR256F	256Mb	1.65V-2.0V	4KB / 32KB / 64KB	Single / Dual / Quad	104MHz(x1, x2, x4)	WSON8 6x5mm WSON8 8x6mm
GD25LB512ME	512Mb	1.65V-2.0V	4KB / 32KB / 64KB	Single / Quad	166MHz(x1, x4) 90MHz(DTR)	SOP16 300mil WSON8 8x6mm TFBGA24 8x6mm (5x5 ball array) WLCSP (3-2-3 ball array)
GD25LR512ME	512Mb	1.65V-2.0V	4KB / 32KB / 64KB	Single / Quad	104MHz(x1, x4) 60MHz(DTR)	SOP16 300mil WSON8 8x6mm
GD25LT512ME	512Mb	1.65V-2.0V	4KB / 32KB / 64KB	Single / Quad	166MHz(x1, x4) 200MHz(DTR)	SOP16 300mil WSON8 8x6mm TFBGA24 8x6mm (5x5 ball array)
GD25LX512ME	512Mb	1.65V-2.0V	4KB / 32KB / 64KB	Single / Octal	166MHz(x1, x8) 200MHz(DTR)	SOP16 300mil TFBGA24 8x6mm (5x5 ball array) WLCSP (4x6 ball array)
GD55LB01GE	1Gb	1.65V-2.0V	4KB / 32KB / 64KB	Single / Quad	166MHz(x1, x4) 90MHz(DTR)	SOP16 300mil WSON8 8x6mm TFBGA24 8x6mm (5x5 ball array)
GD55LT01GE	1Gb	1.65V-2.0V	4KB / 32KB / 64KB	Single / Quad	166MHz(x1, x4) 200MHz(DTR)	SOP16 300mil WSON8 8x6mm TFBGA24 8x6mm (5x5 ball array)
GD55LX01GE	1Gb	1.65V-2.0V	4KB / 32KB / 64KB	Single / Octal	166MHz(x1, x8) 200MHz(DTR)	SOP16 300mil TFBGA24 8x6mm (5x5 ball array)
GD55LB02GE	2Gb	1.65V-2.0V	4KB / 32KB / 64KB	Single / Quad	166MHz(x1, x4) 90MHz(DTR)	TFBGA24 8x6mm (5x5 ball array)
GD55LT02GE	2Gb	1.65V-2.0V	4KB / 32KB / 64KB	Single / Quad	166MHz(x1, x4) 200MHz(DTR)	TFBGA24 8x6mm (5x5 ball array)
GD55LX02GE	2Gb	1.65V-2.0V	4KB / 32KB / 64KB	Single / Octal	166MHz(x1, x8) 200MHz(DTR)	TFBGA24 8x6mm (5x5 ball array)
GD25D05C	512Kb	2.7V-3.6V	4KB / 32KB / 64KB	Single / Dual Output	100MHz(x1) 80MHz(x2)	SOP8 150mil TSSOP8 173mil USON8 1.5x1.5mm USON8 3x2mm
GD25D10C	1Mb	2.7V-3.6V	4KB / 32KB / 64KB	Single / Dual Output	100MHz(x1) 80MHz(x2)	SOP8 150mil TSSOP8 173mil USON8 1.5x1.5mm USON8 3x2mm
GD25Q20E	2Mb	2.7V-3.6V	4KB / 32KB / 64KB	Single / Dual / Quad	133MHz(x1, x2, x4)	SOP8 150mil SOP8 208mil USON8 3x2mm
GD25D20E	2Mb	2.7V-3.6V	4KB / 32KB / 64KB	Single / Dual Output	104MHz(x1) 80MHz(x2)	SOP8 150mil SOP8 208mil USON8 1.5x1.5mm USON8 3x2mm
GD25Q40E	4Mb	2.7V-3.6V	4KB / 32KB / 64KB	Single / Dual / Quad	133MHz(x1, x2, x4)	SOP8 150mil SOP8 208mil USON8 1.5x1.5mm USON8 3x2mm
GD25D40E	4Mb	2.7V-3.6V	4KB / 32KB / 64KB	Single / Dual Output	104MHz(x1) 80MHz(x2)	SOP8 150mil SOP8 208mil USON8 1.5x1.5mm USON8 3x2mm

Part No.	Density	Voltage	Organization	I/O Bus	Frequency (MHz)	Package
GD25Q80E	8Mb	2.7V-3.6V	4KB / 32KB / 64KB	Single / Dual / Quad	133MHz(x1, x2, x4)	SOP8 150mil SOP8 208mil USON8 3x2mm
GD25D80E	8Mb	2.7V-3.6V	4KB / 32KB / 64KB	Single / Dual Output	104MHz(x1) 80MHz(x2)	SOP8 150mil SOP8 208mil USON8 1.5x1.5mm USON8 3x2mm
GD25B16E	16Mb	2.7V-3.6V	4KB / 32KB / 64KB	Single / Dual / Quad	133MHz(x1, x2, x4)	SOP8 150mil SOP8 208mil USON8 3x2mm USON8 3x4mm
GD25Q16E	16Mb	2.7V-3.6V	4KB / 32KB / 64KB	Single / Dual / Quad	133MHz(x1, x2, x4)	SOP8 150mil SOP8 208mil USON8 3x2mm USON8 3x4mm
GD25B32E	32Mb	2.7V-3.6V	4KB / 32KB / 64KB	Single / Dual / Quad	133MHz(x1, x2, x4)	SOP8 150mil SOP8 208mil USON8 3x2mm USON8 3x4mm
GD25Q32E	32Mb	2.7V-3.6V	4KB / 32KB / 64KB	Single / Dual / Quad	133MHz(x1, x2, x4)	SOP8 150mil SOP8 208mil USON8 3x2mm USON8 3x4mm
GD25B64E	64Mb	2.7V-3.6V	4KB / 32KB / 64KB	Single / Dual / Quad	133MHz(x1, x2, x4)	SOP8 208mil USON8 3x4mm USON8 4x4mm WSON8 6x5mm
GD25R64E	64Mb	2.7V-3.6V	4KB / 32KB / 64KB	Single / Dual / Quad	104MHz(x1, x2, x4)	SOP8 208mil WSON8 6x5mm WSON8 8x6mm
GD25F64F	64Mb	2.7V-3.6V	4KB / 32KB / 64KB	Single / Dual / Quad	166MHz(x1,x2,x4) 104MHz(DTR)	SOP8 208mil USON8 4x4mm WSON8 6x5mm TFBGA24 8x6mm(5x5 ball array)
GD25Q64E	64Mb	2.7V-3.6V	4KB / 32KB / 64KB	Single / Dual / Quad	133MHz(x1, x2, x4)	SOP8 150mil SOP8 208mil USON8 3x4mm USON8 4x4mm WSON8 6x5mm TFBGA24 8x6mm (4x6 ball array)
GD25B128E	128Mb	2.7V-3.6V	4KB / 32KB / 64KB	Single / Dual / Quad	133MHz(x1, x2, x4)	SOP8 208mil USON8 4x4mm WSON8 6x5mm WSON8 8x6mm TFBGA24 8x6mm (5x5 ball array)
GD25Q128E	128Mb	2.7V-3.6V	4KB / 32KB / 64KB	Single / Dual / Quad	133MHz(x1, x2, x4)	SOP8 208mil SOP16 300mil USON8 4x4mm WSON8 6x5mm WSON8 8x6mm TFBGA24 8x6mm (5x5 ball array) TFBGA24 8x6mm (4x6 ball array)
GD25R128E	128Mb	2.7V-3.6V	4KB / 32KB / 64KB	Single / Dual / Quad	104MHz(x1, x2, x4)	SOP8 208mil WSON8 6x5mm WSON8 8x6mm
GD25F128F	128Mb	2.7V-3.6V	4KB / 32KB / 64KB	Single / Dual / Quad	166MHz(x1, x2, x4) 104MHz(DTR)	SOP8 208mil SOP16 300mil WSON8 6x5mm TFBGA24 8x6mm (5x5 ball array)
GD25R256E	256Mb	2.7V-3.6V	4KB / 32KB / 64KB	Single / Dual / Quad	104MHz(x1, x2, x4)	SOP16 300mil WSON8 6x5mm WSON8 8x6mm
GD25B256E	256Mb	2.7V-3.6V	4KB / 32KB / 64KB	Single / Dual / Quad	133MHz(x1, x2, x4)	SOP16 300mil WSON8 6x5mm WSON8 8x6mm TFBGA24 8x6mm (5x5 ball array)
GD25F256F	256Mb	2.7V-3.6V	4KB / 32KB / 64KB	Single / Dual / Quad	166MHz(x1, x2, x4) 104MHz(DTR)	SOP16 300mil WSON8 6x5mm WSON8 8x6mm TFBGA24 8x6mm (5x5 ball array)
GD25Q256E	256Mb	2.7V-3.6V	4KB / 32KB / 64KB	Single / Dual / Quad	133MHz(x1, x2, x4)	SOP16 300mil WSON8 6x5mm WSON8 8x6mm TFBGA24 8x6mm (5x5 ball array)
GD25B512ME	512Mb	2.7V-3.6V	4KB / 32KB / 64KB	Single / Quad	133MHz(x1, x4) 90MHz(DTR)	SOP16 300mil WSON8 8x6mm TFBGA24 8x6mm (5x5 ball array)
GD25R512ME	512Mb	2.7V-3.6V	4KB / 32KB / 64KB	Single / Quad	104MHz(x1, x4) 60MHz(DTR)	SOP16 300mil WSON8 8x6mm
GD25T512ME	512Mb	2.7V-3.6V	4KB / 32KB / 64KB	Single / Quad	166MHz(x1, x4) 200MHz(DTR)	SOP16 300mil WSON8 8x6mm TFBGA24 8x6mm (5x5 ball array)
GD25X512ME	512Mb	2.7V-3.6V	4KB / 32KB / 64KB	Single / Octal	166MHz(x1, x8) 200MHz(DTR)	SOP16 300mil TFBGA24 8x6mm (5x5 ball array)
GD25B512MF	512Mb	2.7V-3.6V	4KB / 32KB / 64KB	Single / Dual / Quad	133MHz(x1,x2,x4)	SOP16 300mil WSON8 8x6mm TFBGA24 8x6mm (5x5 ball array)
GD25F512MF	512Mb	2.7V-3.6V	4KB / 32KB / 64KB	Single / Dual / Quad	166MHz(x1,x2,x4)104MHz(DTR)	SOP16 300mil WSON8 8x6mm TFBGA24 8x6mm (5x5 ball array)
GD25R512MF	512Mb	2.7V-3.6V	4KB / 32KB / 64KB	Single / Dual / Quad	104MHz(x1,x2,x4)	SOP16 300mil WSON8 8x6mm
GD55B01GE	1Gb	2.7V-3.6V	4KB / 32KB / 64KB	Single / Quad	133MHz(x1, x4) 90MHz(DTR)	SOP16 300mil WSON8 8x6mm TFBGA24 8x6mm (5x5 ball array)
GD55T01GE	1Gb	2.7V-3.6V	4KB / 32KB / 64KB	Single / Quad	166MHz(x1, x4) 200MHz(DTR)	SOP16 300mil WSON8 8x6mm TFBGA24 8x6mm (5x5 ball array)
GD55X01GE	1Gb	2.7V-3.6V	4KB / 32KB / 64KB	Single / Octal	166MHz(x1, x8) 200MHz(DTR)	SOP16 300mil TFBGA24 8x6mm (5x5 ball array)
GD55B01GF	1Gb	2.7V-3.6V	4KB / 32KB / 64KB	Single / Dual / Quad	133MHz(x1,x2,x4)	SOP16 300mil WSON8 8x6mm TFBGA24 8x6mm (5x5 ball array)
GD55F01GF	1Gb	2.7V-3.6V	4KB / 32KB / 64KB	Single / Dual / Quad	166MHz(x1,x2,x4)104MHz(DTR)	SOP16 300mil WSON8 8x6mm TFBGA24 8x6mm (5x5 ball array)
GD55B02GE	2Gb	2.7V-3.6V	4KB / 32KB / 64KB	Single / Quad	133MHz(x1, x4) 90MHz(DTR)	TFBGA24 8x6mm (5x5 ball array)
GD55T02GE	2Gb	2.7V-3.6V	4KB / 32KB / 64KB	Single / Quad	166MHz(x1, x4) 200MHz(DTR)	TFBGA24 8x6mm (5x5 ball array)
GD55X02GE	2Gb	2.7V-3.6V	4KB / 32KB / 64KB	Single / Octal	166MHz(x1, x8) 200MHz(DTR)	TFBGA24 8x6mm (5x5 ball array)
GD55B02GF	2Gb	2.7V-3.6V	4KB / 32KB / 64KB	Single / Dual / Quad	133MHz(x1,x2,x4)	TFBGA24 8x6mm (5x5 ball array)
GD55F02GF	2Gb	2.7V-3.6V	4KB / 32KB / 64KB	Single / Dual / Quad	166MHz(x1,x2,x4)104MHz(DTR)	TFBGA24 8x6mm (5x5 ball array)
GD25WD05C	512Kb	1.65V-3.6V	4KB / 32KB / 64KB	Single / Dual Output	100MHz(x1) 80MHz(x2)	SOP8 150mil USON8 1.5x1.5mm USON8 3x2mm USON6 1.2x1.2mm
GD25WD10C	1Mb	1.65V-3.6V	4KB / 32KB / 64KB	Single / Dual Output	100MHz(x1) 80MHz(x2)	SOP8 150mil USON8 1.5x1.5mm USON8 3x2mm USON6 1.2x1.2mm
GD25WQ20E	2Mb	1.65V-3.6V	4KB / 32KB / 64KB	Single / Dual / Quad	104MHz(x1, x2, x4)	SOP8 150mil USON8 3x2mm
GD25WD20E	2Mb	1.65V-3.6V	4KB / 32KB / 64KB	Single / Dual Output	104MHz(x1) 80MHz(x2)	SOP8 150mil USON8 1.5x1.5mm USON8 3x2mm USON6 1.2x1.2mm
GD25WQ40E	4Mb	1.65V-3.6V	4KB / 32KB / 64KB	Single / Dual / Quad	104MHz(x1, x2, x4)	SOP8 150mil USON8 3x2mm
GD25WD40E	4Mb	1.65V-3.6V	4KB / 32KB / 64KB	Single / Dual Output	104MHz(x1) 80MHz(x2)	SOP8 150mil TSSOP8 173mil USON8 1.5x1.5mm USON8 3x2mm WLCSP (3-3 ball array) USON6 1.2x1.2mm
GD25WQ80E	8Mb	1.65V-3.6V	4KB / 32KB / 64KB	Single / Dual / Quad	104MHz(x1, x2, x4)	SOP8 150mil SOP8 208mil USON8 3x2mm
GD25WD80E	8Mb	1.65V-3.6V	4KB / 32KB / 64KB	Single / Dual Output	104MHz(x1) 80MHz(x2)	SOP8 150mil SOP8 208mil USON8 1.5x1.5mm USON8 3x2mm
GD25WQ16E	16Mb	1.65V-3.6V	4KB / 32KB / 64KB	Single / Dual / Quad	104MHz(x1, x2, x4)	SOP8 150mil SOP8 208mil USON8 3x2mm USON8 3x4mm
GD25WQ32E	32Mb	1.65V-3.6V	4KB / 32KB / 64KB	Single / Dual / Quad	104MHz(x1, x2, x4)	SOP8 150mil SOP8 208mil USON8 3x2mm USON8 3x4mm
GD25WQ64E	64Mb	1.65V-3.6V	4KB / 32KB / 64KB	Single / Dual / Quad	104MHz(x1, x2, x4)	SOP8 208mil USON8 3x4mm USON8 4x4mm WSON8 6x5mm WLCSP (3-2-3 ball array)
GD25WQ128E	128Mb	1.65V-3.6V	4KB / 32KB / 64KB	Single / Dual / Quad	104MHz(x1, x2, x4)	SOP8 208mil SOP16 300mil USON8 4x4mm WSON8 6x5mm
GD25WB256E	256Mb	1.65V-3.6V	4KB / 32KB / 64KB	Single / Dual / Quad	104MHz(x1, x2, x4)	SOP16 300mil WSON8 6x5mm WSON8 8x6mm
GD25WR256E	256Mb	1.65V-3.6V	4KB / 32KB / 64KB	Single / Dual / Quad	104MHz(x1, x2, x4)	SOP16 300mil WSON8 6x5mm WSON8 8x6mm
GD55WB512ME	512Mb	1.65V-3.6V	4KB / 32KB / 64KB	Single / Dual / Quad	104MHz(x1, x2, x4)	SOP16 300mil WSON8 6x5mm WSON8 8x6mm TFBGA24 8x6mm(5x5 ball array)
GD55WR512ME	512Mb	1.65V-3.6V	4KB / 32KB / 64KB	Single / Dual / Quad	104MHz(x1, x2, x4)	SOP16 300mil WSON8 8x6mm
GD25UF64E	64Mb	1.14V-1.26V	4KB / 32KB / 64KB	Single / Dual / Quad	120MHz(x1,x2,x4)60MHz(DTR)	SOP8 208mil USON8 3x4mm USON8 4x4mm WLCSP
GD25UF128E	128Mb	1.14V-1.26V	4KB / 32KB / 64KB	Single / Dual / Quad	120MHz(x1,x2,x4)60MHz(DTR)	SOP8 208mil USON8 4x4mm WSON8 6x5mm TFBGA24 8x6mm (5x5 ball array) WLCSP

Product Series

3V

Q: Quad I/O
 B: Quad I/O, Default x4 I/O
 F: Quad I/O, Default x4 I/O, High Performance
 T: Quad I/O, Default x4 I/O, Ultra-High Performance
 X: Octal I/O, Ultra-High Performance
 D: Dual I/O
 R: Quad I/O, Stack RPMC

1.8V

LQ/LE/LH: Quad I/O
 LB: Quad I/O, Default x4 I/O
 LF: Quad I/O, Default x4 I/O, High Performance
 LT: Quad I/O, Default x4 I/O, Ultra-High Performance
 LX: Octal I/O, Ultra-High Performance
 LD: Dual I/O
 LR: Quad I/O, Stack RPMC

1.65V~3.6V

WD: Dual Output
 WQ: Quad I/O
 WB: Quad I/O, Default x4 I/O
 WR: Quad I/O, Default x4 I/O

1.2V

UF: Quad I/O, Default x4 I/O



GD SPI NOR Flash (Automotive) Product List

Part No.	Density	Voltage	Organization	I/O Bus	Frequency (MHz)	Packages
GD25Q20E	2Mb	2.7V-3.6V	4KB / 32KB / 64KB	Single / Dual / Quad	133MHz(x1, x2, x4)	USON8 3x2mm
GD25Q40E	4Mb	2.7V-3.6V	4KB / 32KB / 64KB	Single / Dual / Quad	133MHz(x1, x2, x4)	SOP8 150mil USON8 3x2mm
GD25Q80E	8Mb	2.7V-3.6V	4KB / 32KB / 64KB	Single / Dual / Quad	133MHz(x1, x2, x4)	SOP8 150mil SOP8 208mil USON8 3x2mm
GD25B16E	16Mb	2.7V-3.6V	4KB / 32KB / 64KB	Single / Dual / Quad	133MHz(x1, x2, x4)	SOP8 150mil SOP8 208mil USON8 3x2mm USON8 3x4mm
GD25B32E	32Mb	2.7V-3.6V	4KB / 32KB / 64KB	Single / Dual / Quad	133MHz(x1, x2, x4)	SOP8 150mil SOP8 208mil USON8 3x2mm USON8 3x4mm
GD25F64F	64Mb	2.7V-3.6V	4KB / 32KB / 64KB	Single / Dual / Quad	166MHz(x1, x2, x4) 104MHz(DTR)	SOP8 208mil USON8 4x4mm WSON8 6x5mm
GD25F128F	128Mb	2.7V-3.6V	4KB / 32KB / 64KB	Single / Dual / Quad	166MHz(x1, x2, x4) 104MHz(DTR)	SOP8 208mil SOP16 300mil WSON8 6x5mm WSON8 8x6mm TFBGA24 8x6mm (5x5 ball array)
GD25F256F	256Mb	2.7V-3.6V	4KB / 32KB / 64KB	Single / Dual / Quad	166MHz(x1, x2, x4) 104MHz(DTR)	SOP16 300mil WSON8 6x5mm WSON8 8x6mm TFBGA24 8x6mm (5x5 ball array)
GD25T512ME	512Mb	2.7V-3.6V	4KB / 32KB / 64KB	Single / Quad	166MHz(x1, x4) 200MHz(DTR)	SOP16 300mil WSON8 8x6mm TFBGA24 8x6mm (5x5 ball array)
GD25X512ME	512Mb	2.7V-3.6V	4KB / 32KB / 64KB	Single / Octal	166MHz(x1, x8) 200MHz(DTR)	SOP16 300mil TFBGA24 8x6mm (5x5 ball array)
GD55T01GE	1Gb	2.7V-3.6V	4KB / 32KB / 64KB	Single / Quad	166MHz(x1, x4) 200MHz(DTR)	SOP16 300mil WSON8 8x6mm TFBGA24 8x6mm (5x5 ball array)
GD55X01GE	1Gb	2.7V-3.6V	4KB / 32KB / 64KB	Single / Octal	166MHz(x1, x8) 200MHz(DTR)	SOP16 300mil TFBGA24 8x6mm (5x5 ball array)
GD55T02GE	2Gb	2.7V-3.6V	4KB / 32KB / 64KB	Single / Quad	166MHz(x1, x4) 200MHz(DTR)	TFBGA24 8x6mm (5x5 ball array)
GD55X02GE	2Gb	2.7V-3.6V	4KB / 32KB / 64KB	Single / Octal	166MHz(x1, x8) 200MHz(DTR)	TFBGA24 8x6mm (5x5 ball array)
GD25LQ20E	2Mb	1.65V-2.0V	4KB / 32KB / 64KB	Single / Dual / Quad	133MHz(x1, x2, x4)	USON8 3x2mm
GD25LQ40E	4Mb	1.65V-2.0V	4KB / 32KB / 64KB	Single / Dual / Quad	133MHz(x1, x2, x4)	USON8 3x2mm
GD25LQ80E	8Mb	1.65V-2.0V	4KB / 32KB / 64KB	Single / Dual / Quad	133MHz(x1, x2, x4)	USON8 3x2mm
GD25LQ16E	16Mb	1.65V-2.0V	4KB / 32KB / 64KB	Single / Dual / Quad	133MHz(x1, x2, x4)	SOP8 150mil SOP8 208mil USON8 3x2mm
GD25LQ32E	32Mb	1.65V-2.0V	4KB / 32KB / 64KB	Single / Dual / Quad	133MHz(x1, x2, x4)	SOP8 150mil SOP8 208mil USON8 3x2mm USON8 3x4mm
GD25LQ64E	64Mb	1.65V-2.0V	4KB / 32KB / 64KB	Single / Dual / Quad	133MHz(x1, x2, x4)	SOP8 150mil SOP8 208mil USON8 3x4mm USON8 4x4mm WSON8 6x5mm
GD25LQ128D	128Mb	1.65V-2.0V	4KB / 32KB / 64KB	Single / Dual / Quad	120MHz(x1, x2, x4)	SOP8 208mil WSON8 6x5mm TFBGA24 8x6mm (5x5 ball array)
GD25LX256E	256Mb	1.65V-2.0V	4KB / 32KB / 64KB	Single / Octal	166MHz(x1, x8) 200MHz(DTR)	SOP16 300mil TFBGA24 8x6mm (5x5 ball array)
GD25LT256E	256Mb	1.65V-2.0V	4KB / 32KB / 64KB	Single / Quad	166MHz(x1, x4) 200MHz(DTR)	WSON8 6x5mm WSON8 8x6mm TFBGA24 8x6mm (5x5 ball array)
GD25LX512ME	512Mb	1.65V-2.0V	4KB / 32KB / 64KB	Single / Octal	166MHz(x1, x8) 200MHz(DTR)	SOP16 300mil TFBGA24 8x6mm (5x5 ball array)
GD25LT512ME	512Mb	1.65V-2.0V	4KB / 32KB / 64KB	Single / Quad	166MHz(x1, x4) 200MHz(DTR)	WSON8 8x6mm TFBGA24 8x6mm (5x5 ball array)
GD55LX01GE	1Gb	1.65V-2.0V	4KB / 32KB / 64KB	Single / Octal	166MHz(x1, x8) 200MHz(DTR)	SOP16 300mil TFBGA24 8x6mm (5x5 ball array)
GD55LT01GE	1Gb	1.65V-2.0V	4KB / 32KB / 64KB	Single / Quad	166MHz(x1, x4) 200MHz(DTR)	WSON8 8x6mm TFBGA24 8x6mm (5x5 ball array)
GD55LX02GE	2Gb	1.65V-2.0V	4KB / 32KB / 64KB	Single / Octal	166MHz(x1, x8) 200MHz(DTR)	TFBGA24 8x6mm (5x5 ball array)
GD55LT02GE	2Gb	1.65V-2.0V	4KB / 32KB / 64KB	Single / Quad	166MHz(x1, x4) 200MHz(DTR)	TFBGA24 8x6mm (5x5 ball array)

Product Series

3V

Q: Quad I/O
 B: Quad I/O, Default x4 I/O
 F: Quad I/O, Default x4 I/O, High Performance

T: Quad I/O, Default x4 I/O, Ultra-High Performance
 X: Octal I/O, Ultra-High Performance

1.8V

LQ: Quad I/O
 LT: Quad I/O, Default x4 I/O, Ultra-High Performance

LX: Octal I/O, Ultra-High Performance





SPI NAND Flash

GD SPI NAND Flash Features



3V

- ◆ Power Supply Voltage: 2.7V~3.6V
- ◆ High Speed Clock Frequency:
 - Up to 133MHz for fast read
 - Quad I/O Data transfer up to 532Mbit/s
- ◆ Flexible Memory Architecture:
 - 2K Bytes page for read and program
 - 128K Bytes per block for erase
- ◆ Enhanced Access Performance:
 - 2K Bytes cache for fast random read
- ◆ Advanced Feature for SPI NAND:
 - Internal ECC algorithm
 - Support DTR

1.8V

- ◆ Power Supply Voltage: 1.7V~2.0V
- ◆ High Speed Clock Frequency:
 - Up to 104MHZ for fast read
 - Quad I/O Data transfer up to 416Mbit/s
- ◆ Flexible Memory Architecture:
 - 2K Bytes page for read and program
 - 128K Bytes per block for erase
- ◆ Enhanced Access Performance:
 - 2K Bytes cache for fast random read
- ◆ Advanced Feature for SPI NAND:
 - Internal ECC algorithm
 - Support DTR
 - Support Deep Power Down

GD SPI NAND Flash Product List

Part No.	Density	Voltage	Frequency	I/O Bus	Page Size	Package
GD5F1GQ5UE	1Gb	3V	133MHz	x1/x2/x4	2KB	WSON8 8*6mm/WSON8 6*5mm/TFBGA24(5x5 ball array)
GD5F1GM7UE	1Gb	3V	133MHZ	x1/x2/x4	2KB	WSON8 8*6mm/WSON8 6*5mm/TFBGA24(5x5 ball array)
GD5F2GQ5UE	2Gb	3V	104MHz	x1/x2/x4	2KB	WSON8 8*6mm
GD5F2GM7UE	2Gb	3V	133MHZ	x1/x2/x4	2KB	WSON8 8*6mm/WSON8 6*5mm/TFBGA24(5x5 ball array)
GD5F4GQ6UE	4Gb	3V	104MHZ	x1/x2/x4	2KB	WSON8 8*6mm
GD5F4GM8UE	4Gb	3V	133MHZ	x1/x2/x4	2KB	WSON8 8*6mm/WSON8 6*5mm/TFBGA24(5x5 ball array)
GD5F1GQ5RE	1Gb	1.8V	104MHz	x1/x2/x4	2KB	WSON8 8*6mm/WSON8 6*5mm/TFBGA24(5x5 ball array)
GD5F1GM7RE	1Gb	1.8V	104MHz	x1/x2/x4	2KB	WSON8 8*6mm/WSON8 6*5mm/TFBGA24(5x5 ball array)
GD5F2GQ5RE	2Gb	1.8V	80MHz	x1/x2/x4	2KB	WSON8 8*6mm
GD5F2GM7RE	2Gb	1.8V	104MHz	x1/x2/x4	2KB	WSON8 8*6mm/WSON8 6*5mm/TFBGA24(5x5 ball array)
GD5F4GQ6RE	4Gb	1.8V	80MHZ	x1/x2/x4	2KB	WSON8 8*6mm
GD5F4GM8RE	4Gb	1.8V	104MHZ	x1/x2/x4	2KB	WSON8 8*6mm/WSON8 6*5mm/TFBGA24(5x5 ball array)

GD SPI NAND Flash (Automotive) Product List

Part No.	Density	Voltage	Frequency	I/O Bus	Page Size	Package
GD5F1GQ5UE	1Gb	3V	133MHz	x1/x2/x4	2KB	WSON8 8*6mm
GD5F2GQ5UE	2Gb	3V	104MHZ	x1/x2/x4	2KB	WSON8 8*6mm
GD5F4GQ6UE	4Gb	3V	104MHz	x1/x2/x4	2KB	WSON8 8*6mm
GD5F1GQ5RE	1Gb	1.8V	104MHz	x1/x2/x4	2KB	WSON8 8*6mm
GD5F2GQ5RE	2Gb	1.8V	80MHZ	x1/x2/x4	2KB	WSON8 8*6mm
GD5F4GQ6RE	4Gb	1.8V	80MHz	x1/x2/x4	2KB	WSON8 8*6mm

GD SPI NAND Flash Part Number Definition

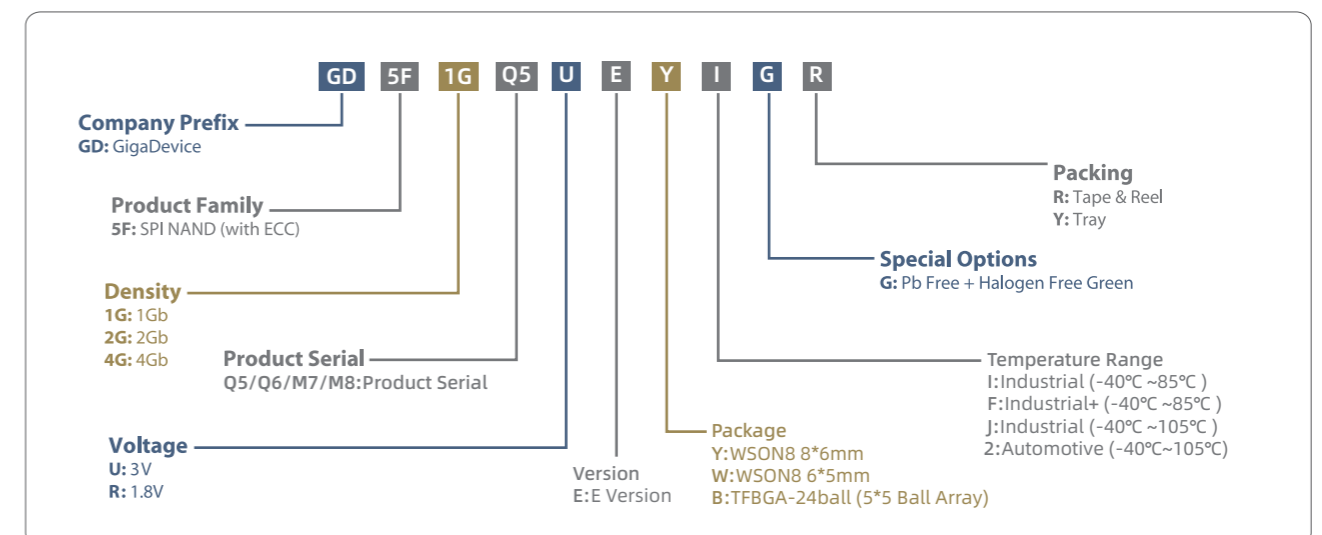

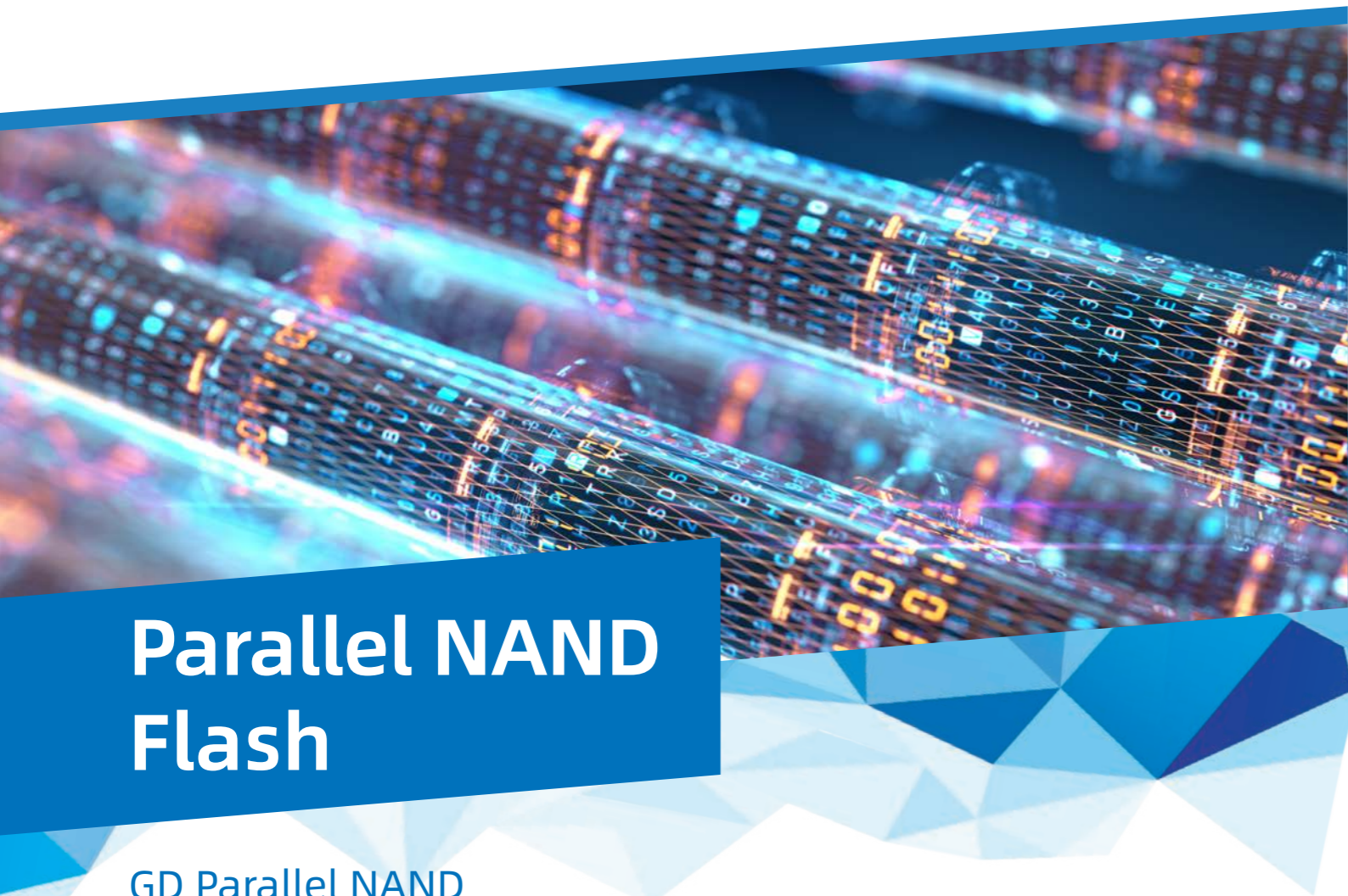

Parallel NAND Flash

GD Parallel NAND Flash Features

3V

- ◆ Power Supply: 2.7V ~ 3.6V
- ◆ Density: 1Gb / 2Gb / 4Gb / 8Gb
- ◆ Page Size: 2K+64 Bytes / 2K+128 Bytes / 4K+256 Bytes
- ◆ Flash Array to Register Time: 25us
- ◆ I/O Read Performance: 12ns / 20ns / 25ns
- ◆ Bus Width: x8 / x16 options
- ◆ Temperature Range: -40° C to 85° C / -40° C to 105° C
- ◆ ONFI 1.0 compatible

1.8V

- ◆ Power Supply: 1.7V ~ 1.95V
- ◆ Density: 1Gb / 2Gb / 4Gb / 8Gb
- ◆ Page Size: 2K+64 Bytes / 2K+128 Bytes
- ◆ Flash Array to Register Time: 25us
- ◆ I/O Read Performance: 20ns/25ns/45ns
- ◆ Bus Width: x8 / x16 options
- ◆ Temperature Range: -40° C to 85° C / -40° C to 105° C
- ◆ ONFI 1.0 compatible

GD Parallel NAND Flash Product List

Part No.	Density	Voltage	Sequential Access Time	I/O Bus	Page Size	ECC Requirement	Package
GD9FU1GxF2A	1Gb	3V	25ns	x8/x16	2KB+128B	4bit/512B	TSOP48 20*12mm/BGA63 9*11mm
GD9FU1GxF3A	1Gb	3V	25ns	x8/x16	2KB+64B	4bit/512B	TSOP48 20*12mm/BGA63 9*11mm
GD9FU1G8F2D	1Gb	3V	12ns	x8	2KB+128B	8bit/512B	TSOP48 20*12mm/BGA63 9*11mm
GD9FU2GxF2A	2Gb	3V	20ns	x8/x16	2KB+128B	4bit/512B	TSOP48 20*12mm/BGA63 9*11mm
GD9FU2GxF3A	2Gb	3V	20ns	x8/x16	2KB+64B	4bit/512B	TSOP48 20*12mm/BGA63 9*11mm
GD9FU4GxF2A	4Gb	3V	20ns	x8/x16	2KB+128B	4bit/512B	TSOP48 20*12mm/BGA63 9*11mm
GD9FU4GxF3A	4Gb	3V	20ns	x8/x16	2KB+64B	4bit/512B	TSOP48 20*12mm/BGA63 9*11mm
GD9FU4GxF4B	4Gb	3V	25ns	x8/x16	4KB+256B	8bit/512B	TSOP48 20*12mm/BGA63 9*11mm
GD9FU8GxE2A	8Gb	3V	20ns	x8/x16	2KB+128B	4bit/512B	TSOP48 20*12mm/BGA63 9*11mm
GD9FU8GxE3A	8Gb	3V	20ns	x8/x16	2KB+64B	4bit/512B	TSOP48 20*12mm/BGA63 9*11mm
GD9FU8GxE4B	8Gb	3V	25ns	x8/x16	4KB+256B	8bit/512B	TSOP48 20*12mm/BGA63 9*11mm
GD9AU2GxF3A*	2Gb	3V	20ns	x8/x16	2KB+64B	Internal 4bit/512B	TSOP48 20*12mm/BGA63 9*11mm
GD9AU4GxF3A*	4Gb	3V	20ns	x8/x16	2KB+64B	Internal 4bit/512B	TSOP48 20*12mm/BGA63 9*11mm
GD9AU8GxE3A*	8Gb	3V	20ns	x8/x16	2KB+64B	Internal 4bit/512B	TSOP48 20*12mm/BGA63 9*11mm
GD9FS1GxF2A	1Gb	1.8V	45ns	x8/x16	2KB+128B	4bit/512B	TSOP48 20*12mm/BGA63 9*11mm
GD9FS1GxF3A	1Gb	1.8V	45ns	x8/x16	2KB+64B	4bit/512B	TSOP48 20*12mm/BGA63 9*11mm
GD9FS1G8F2D	1Gb	1.8V	20ns	x8	2KB+128B	8bit/512B	TSOP48 20*12mm/BGA63 9*11mm
GD9FS2GxF2A	2Gb	1.8V	25ns	x8/x16	2KB+128B	4bit/512B	TSOP48 20*12mm/BGA63 9*11mm
GD9FS2GxF3A	2Gb	1.8V	25ns	x8/x16	2KB+64B	4bit/512B	TSOP48 20*12mm/BGA63 9*11mm
GD9FS4GxF2A	4Gb	1.8V	25ns	x8/x16	2KB+128B	4bit/512B	TSOP48 20*12mm/BGA63 9*11mm
GD9FS4GxF3A	4Gb	1.8V	25ns	x8/x16	2KB+64B	4bit/512B	TSOP48 20*12mm/BGA63 9*11mm
GD9FS8GxE2A	8Gb	1.8V	25ns	x8/x16	2KB+128B	4bit/512B	TSOP48 20*12mm/BGA63 9*11mm
GD9FS8GxE3A	8Gb	1.8V	25ns	x8/x16	2KB+64B	4bit/512B	TSOP48 20*12mm/BGA63 9*11mm
GD9AS2GxF3A*	2Gb	1.8V	25ns	x8/x16	2KB+64B	Internal 4bit/512B	TSOP48 20*12mm/BGA63 9*11mm
GD9AS4GxF3A*	4Gb	1.8V	25ns	x8/x16	2KB+64B	Internal 4bit/512B	TSOP48 20*12mm/BGA63 9*11mm
GD9AS8GxE3A*	8Gb	1.8V	25ns	x8/x16	2KB+64B	Internal 4bit/512B	TSOP48 20*12mm/BGA63 9*11mm

Note: The device has internal 4bit/512B ECC, doesn't need host ECC*.

GD Parallel NAND Flash Part Number Definition

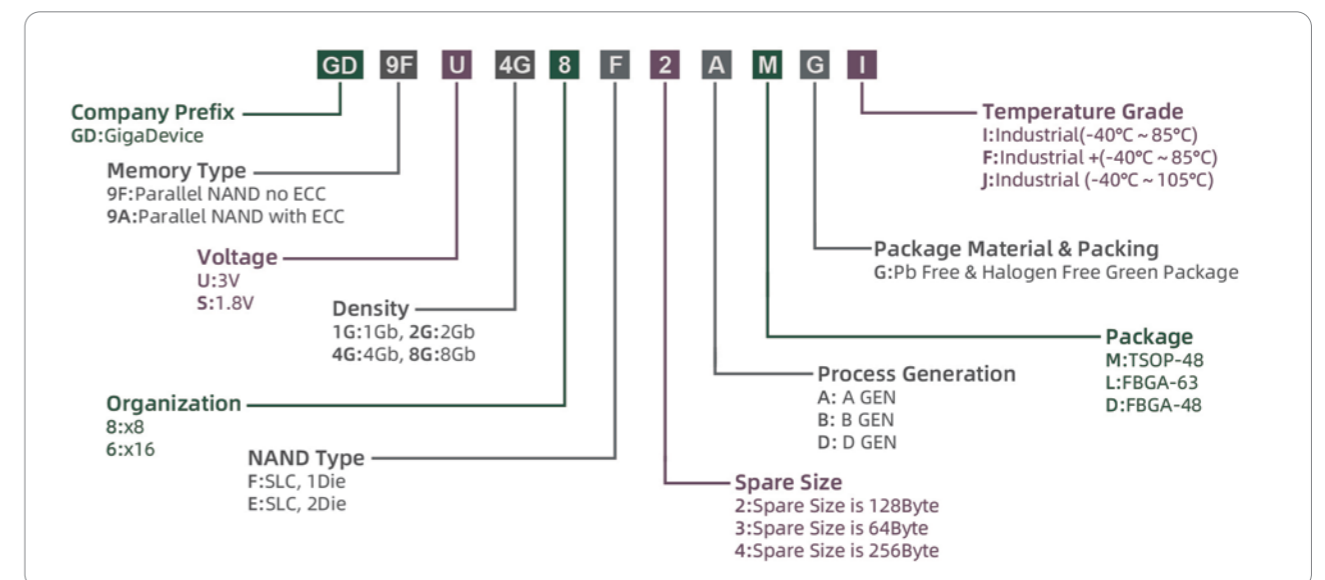

Flash Package Options

Note:

1. The values provided are the typical values for length, width and pitch, as well as the max values for Height.
2. The pictures are for reference only. Please always verify your selection with the product data sheet.

T		SOP8 150mil	
		Length	4.90mm
		Width	6.00mm
		Height(Max)	1.75mm
		Pitch	1.27mm

K6		USON6 1.2*1.2mm	
		Length	1.20mm
		Width	1.20mm
		Height(Max)	0.40mm
		Pitch	0.40mm

8		LGA8 3*2mm	
		Length	3.00mm
		Width	2.00mm
		Height(Max)	0.50mm
		Pitch	0.50mm

Z		TFBGA-24ball 6*8mm (4*6ball array)	
		Length	6.00mm
		Width	8.00mm
		Height(Max)	1.20mm
		Pitch	1.00mm

S		SOP8 208mil	
		Length	5.23mm
		Width	7.90mm
		Height(Max)	2.16mm
		Pitch	1.27mm

K		USON8 1.5*1.5mm	
		Length	1.50mm
		Width	1.50mm
		Height(Max)	0.50mm
		Pitch	0.40mm

9		LGA8 8*6mm	
		Length	8.00mm
		Width	6.00mm
		Height(Max)	0.80mm
		Pitch	1.27mm

B		TFBGA-24ball 6*8mm (5*5ball array)	
		Length	6.00mm
		Width	8.00mm
		Height(Max)	1.20mm
		Pitch	1.00mm

M		VSOP8 150mil	
		Length	4.90mm
		Width	6.00mm
		Height(Max)	0.90mm
		Pitch	1.27mm

E		USON8 3*2mm	
		Length	3.00mm
		Width	2.00mm
		Height(Max)	0.50mm
		Pitch	0.50mm

W		WSON8 6*5mm	
		Length	6.00mm
		Width	5.00mm
		Height(Max)	0.80mm
		Pitch	1.27mm

L		FBGA63	
		Length	9.00mm
		Width	11.0mm
		Height(Max)	1.00mm
		Pitch	0.80mm

V		VSOP8 208mil	
		Length	5.28mm
		Width	7.90mm
		Height(Max)	1.00mm
		Pitch	1.27mm

N		USON8 3*4mm	
		Length	3.00mm
		Width	4.00mm
		Height(Max)	0.60mm
		Pitch	0.80mm

Y		WSON8 8*6mm	
		Length	8.00mm
		Width	6.00mm
		Height(Max)	0.80mm
		Pitch	1.27mm

M		TSOP48	
		Length	20.00mm
		Width	12.00mm
		Height(Max)	1.20mm
		Pitch	0.50mm

F		SOP16 300mil	
		Length	10.30mm
		Width	10.35mm
		Height(Max)	2.65mm
		Pitch	1.27mm

Q		USON8 4*4mm	
		Length	4.00mm
		Width	4.00mm
		Height(Max)	0.50mm
		Pitch	0.80mm

L		WLCSP	
		Depends on specific product	



Capacitive Touchscreen Controller

GD Capacitive Touchscreen Controller Features

- ◆ Outstanding anti RF, LCD and power supply interference
- ◆ Detect up to 10 fingers
- ◆ Panel thickness: glass up to 2.5mm, plastic up to 1.2mm
- ◆ I2C compatible slave mode 400KHz
- ◆ I/O interface: 1.8V /3.3V compatible

GD Capacitive Touch IC for Mobile

Item	GSL1691	GSL2681	GSL915	GSL2338
Number of channels	18TX, 12RX	23TX, 12RX	26TX, 14RX	40 RX
Multi-touch points	5 points	5 points	5 points	2 points
Panel dimension	up to 7"	up to 7"	up to 7"	up to 5.5"
Wake-up gestures	Yes	Yes	Yes	Yes
TP compatible mode	Tx line Floating	Tx line Floating	GPIO(9 mode) + Tx line Floating	Rx line Floating
Panel dimension and pixel	5.0Inch(960*540) 5.0Inch(1280*720) 5.3Inch(800*480) 5.3Inch(960*540) 5.7Inch(1280*720) 6.0Inch(960*540) 6.0Inch(1280*720) 7Inch(800*480) 7Inch(1024*600)	5.0Inch(960*540) 5.0Inch(1280*720) 5.3Inch(800*480) 5.3Inch(960*540) 5.7Inch(1280*720) 6.0Inch(960*540) 6.0Inch(1280*720) 7Inch(800*480) 7Inch(1024*600)	5.0Inch(960*540) 5.0Inch(1280*720) 5.3Inch(800*480) 5.3Inch(960*540) 5.7Inch(1280*720) 6.0Inch(960*540) 6.0Inch(1280*720) 7Inch(800*480) 7Inch(1024*600)	5.0Inch(960*540) 5.0Inch(1280*720) 5.3Inch(800*480) 5.3Inch(960*540) 5.5Inch(1280*720)
Value proposition	Support single layer and multi-touch, high cost effectiveness	Support single layer and multi-touch, high performance	Support single layer and multi-touch, high performance	Self-capacitance, high cost effectiveness
Sensor profile	5*5*0.8mm	6*6*0.8mm	6*6*0.8mm	5*5*0.55mm
Package	QFN40	QFN48	QFN52	QFN48
High channel loading resistance support	Yes	Yes	Yes	Yes
Sensor pattern	OGS, SITO, DITO	OGS, SITO, DITO	OGS, SITO, DITO	SITO (dual segmentation)
Process support	1. Photolithography process 2. Laser process 3. Printing process	1. Photolithography process 2. Laser process 3. Printing process	1. Photolithography process 2. Laser process 3. Printing process	Printing process
Voltage	2.8V/3.0V/3.3V	2.8V/3.0V/3.3V	2.8V/3.0V/3.3V	2.8V/3.0V/3.3V
Communication	I2C	I2C	I2C	I2C

GD Capacitive Touch IC for Tablet Panel

Item	GSL1680	GSL1686	GSL2681	GSL3670	GSL3676	GSL3680	GSL3692	GSL5680
Number of channels	16TX, 10RX	16TX, 10RX	23TX, 12RX	26TX, 14RX	28TX, 18RX	31TX, 20RX	32TX, 24RX	40TX, 32RX
Multi-touch Points	5~10 point	5~10 point	5~10 point	5~10 point	5~10 point	5~10 point	5~10 point	5~10 point
Panel dimension	up to 7"	up to 7"	up to 8"	up to 10.1"	up to 10.1"	up to 13.5"	up to 13.5"	up to 15.6"
Wake-up gestures	Yes	Yes	Yes	Yes	Yes	Yes	Yes	Yes
TP compatible mode	GPIO(2 modes)+ Tx line floating	GPIO(2 modes)+ Tx line floating	Tx line floating	GPIO(9 modes)+ Tx line floating	Tx line floating	GPIO(8 modes)+ Tx line floating	GPIO(6 modes)+ Tx line floating	GPIO(9 modes)+ Tx line floating
Panel dimension and pixel	7Inch(800*480) 7Inch(1024*600) 8Inch(800*600)	7Inch(800*480) 7Inch(1024*600) 8Inch(800*600)	7Inch(1024*600) 7Inch(1280*800) 7.85Inch(1024*768) 8Inch(800*600) 8Inch(1024*768)	7Inch(1280*800) 7.85Inch(1024*768) 7.85Inch(1280*800) 8Inch(1024*768) 8Inch(1280*800) 9Inch(800*480) 9Inch(1024*600) 9Inch(1024*768) 9Inch(1280*800) 9.7Inch(800*480) 10.1Inch(1024*768) 10.1Inch(1366*768)	7Inch(1280*800) 7.85Inch(1024*768) 7.85Inch(1280*800) 8Inch(1024*768) 8Inch(1280*800) 9Inch(800*480) 9Inch(1024*600) 9Inch(1024*768) 9Inch(1280*800) 9.7Inch(800*480) 10.1Inch(1024*768) 10.1Inch(1366*768)	7Inch(1280*800) 7.85Inch(1024*768) 7.85Inch(1280*800) 8Inch(1024*768) 8Inch(1280*800) 9Inch(800*480) 9Inch(1024*600) 9Inch(1024*768) 9Inch(1280*800) 9.7Inch(800*480) 10.1Inch(1024*768) 10.1Inch(1366*768) customer requirement	7Inch(1280*800) 7.85Inch(1024*768) 7.85Inch(1280*800) 8Inch(1024*768) 8Inch(1280*800) 9Inch(800*480) 9Inch(1024*600) 9Inch(1024*768) 9Inch(1280*800) 9.7Inch(800*480) 10.1Inch(1024*768) 10.1Inch(1366*768) customer requirement	7Inch(1280*800) 7.85Inch(1024*768) 7.85Inch(1280*800) 8Inch(1024*768) 8Inch(1280*800) 9Inch(800*480) 9Inch(1024*600) 9Inch(1024*768) 9Inch(1280*800) 9.7Inch(800*480) 10.1Inch(1024*768) 10.1Inch(1366*768) customer requirement
Sensor profile	5*5*0.8mm	5*5*0.8mm	6*6*0.8mm	6*6*0.8mm	7*7*0.8mm	8*8*0.8mm	8*8*0.8mm	10*10*0.8mm
Package	QFN40	QFN40	QFN48	QFN52	QFN56	QFN68	QFN68	QFN88
Value proposition	Support single layer and multi-touch, high cost effectiveness	Support single layer and multi-touch, high cost effectiveness, compatible with GSL1680	Support single layer and multi-touch, high cost effectiveness	Support single layer and multi-touch, high cost effectiveness	Support single layer and multi-touch, big panel size	Support single layer and multi-touch, big panel size	Support single layer and multi-touch, big panel size	Support single layer and multi-touch, big panel size
High channel loading resistance support	Yes	Yes	Yes	Yes	Yes	Yes	Yes	Yes
Sensor pattern	DITO	OGS, SITO, DITO	OGS, SITO, DITO	OGS, SITO, DITO	OGS, SITO, DITO	OGS, SITO, DITO	OGS, SITO, DITO	DITO
Process support	1. Photolithography process 2. Laser process 3. Printing process	1. Photolithography process 2. Laser process 3. Printing process	1. Photolithography process 2. Laser process 3. Printing process	1. Photolithography process 2. Laser process 3. Printing process	1. Photolithography process 2. Laser process 3. Printing process	1. Photolithography process 2. Laser process 3. Printing process	1. Photolithography process 2. Laser process 3. Printing process	1. Photolithography process 2. Laser process 3. Printing process
Voltage	2.8V/3.0V/3.3V	2.8V/3.0V/3.3V	2.8V/3.0V/3.3V	2.8V/3.0V/3.3V	2.8V/3.0V/3.3V	2.8V/3.0V/3.3V	2.8V/3.0V/3.3V	2.8V/3.0V/3.3V
Communication	I2C	I2C	I2C	I2C	I2C	I2C	I2C	I2C



Fingerprint Sensor

GD Capacitive Fingerprint Sensor Features

- ◆ Diverse shapes: round, square, rectangular etc.
- ◆ All kinds of typical sizes: different diameters, different side lengths, especially ultra-slim
- ◆ Front/Back/Side-Mounted package sensor type
- ◆ Supports different surface materials: matte / glossy coating, ceramic / glass cover
- ◆ High sensitivity, high SNR, high quality image
- ◆ 256 true gray scale values, 8 bits per pixel
- ◆ Support standard SPI bus interface
- ◆ Resolution: 508 DPI
- ◆ Adaptive calibration: automatically adjusts the sensor configuration according to the different types of fingerprint
- ◆ Adaptive for many kinds of algorithm includes finger pattern and feature points
- ◆ Getting the high definition fingerprint image without a metal ring module
- ◆ Smart wake-up feature
- ◆ FRR<2% @ FAR 1/50000

Electrical Properties

- ◆ Supply voltage: 2.6V ~ 3.6V
- ◆ VDDIO voltage: 1.8V ~ AVDD
- ◆ Power consumption:
 - Image scan mode (frame rate>20F/s or custom): 8.5mA (configurable)
 - Sleep mode (before awoken): 100µA (typically)
 - Deep sleep mode: 30~100µA

Reliability

- ◆ Sensor ESD performance:
 - Air discharge: ±15.0 kV
 - Direct discharge: ±8.0 kV
- ◆ Sensor Latch-up performance: ±400.00mA

GD Capacitive Fingerprint Sensor

Part No.	Type	Position	LGA Size / Square	LGA Size / Round	Sensing Size	Pixel Array
GSL6157N	Matte / Glossy Coating	Side-Mounted	14.3*2.4mm		8 x 1.8mm	160 x 36
GSL6159N	Matte / Glossy Coating	Side-Mounted	13.5*2.12mm		8 x 1.6mm	160 x 32
GSL6157R	Matte / Glossy Coating	Curved Side-Mounted	14.3*2.4mm		8 x 1.8mm	160 x 36
GSL6191N	Matte / Glossy Coating	Side-Mounted	14.3*2.4 ~ 13.5*2.12		6.6 x 1.6mm	132 x 32
GSL6192	Matte / Glossy Coating	Side-Mounted	13.5*1.8		8 x 1.3mm	180 x 30
GSL6193	Matte / Glossy Coating	Side-Mounted	14.3*2.4 ~ 13.5*2.12		5.9 x 1.6mm	118 x 32
GSL6150N	Matte / Glossy Coating	Back-Mounted	Max:12x12mm Min:7.5x7.5mm	Max:φ12mm Min:φ8.5mm	4.0 x 3.2mm	80 x 64
GSL6135N	Matte / Glossy Coating	Back-Mounted	Max:12x12mm Min:7.5x7.5mm	Max:φ12 Min:φ8.5	3.2 x 3.2mm	64 x 64
GSL6182GS1	Matte / Glossy Coating	Smart door lock	Max:15x15mm Min:12.5x12.5mm	Max:φ15mm Min:φ12.5mm	5.7 x 6.6mm	128 x 112
GSL6186	Matte / Glossy Coating	Smart door lock	Max:13x13mm Min:10.5x10.5mm	Max:φ13mm Min:φ10.5mm	6.4 x 3.2mm	128 x 64
GSL6186C1	Matte / Glossy Coating	PC	Max:13x13mm Min:10.5x10.5mm	Max:φ13mm Min:φ10.5mm	4.0 x 3.2mm	80 x 64

GD Optical Fingerprint Sensor Features

- ◆ Different types of optical sensors under the display: CCM (CSM)
- ◆ All kinds of OLED type supported (both rigid and flexible OLED)
- ◆ FRR ≤ 1.5% @ FAR ≤ 1/50,000
- ◆ Enroll times ≤ 12 times
- ◆ All 360 degrees can be identified



Under OLED Optical Fingerprint Sensor

- ◆ Large size pixel design for low-light under display fingerprint application
- ◆ Advanced single-chip architecture
- ◆ Optimized lens design matching pixel array
- ◆ No flash supported
- ◆ Firstly introduce CSP (Chip Scale Package) in under-display fingerprint application

GD Optical Fingerprint Sensor Under OLED

Part No.	Finger Touch Size	Pixel Array
GSL7000A	6.0 x 6.0 mm	320 x 320
GSL7001A	6.0 x 6.0 mm	250 x 250
GSL7002A	7.0 x 7.0 mm	200 x 200

GigaDevice Semiconductor Inc.

Beijing Headquarter

Building No.8, IC Park, No.9 Fenghao East Road,
Haidian, Beijing, China
Tel: +86-10-82881666
Fax: +86-10-82881668
E-mail: info@gigadevice.com

6/F, Cheng'ao Plaza, No.5, Anding Road,
Chaoyang District, Beijing
Tel: +86-10-82881666
E-mail: info@gigadevice.com

Shanghai

Room 603, Tianshan Road 18,
Zhaoyi Science Zone,
Shanghai, China
Tel: +86-21-32567770
E-mail: info@gigadevice.com

11F-15F, Zhanxiang Bld,
No.505, Zhangjiang Road
Pudong, Shanghai 201210, China
Tel: +86-10-20221991
E-mail: info@gigadevice.com

Shenzhen

3501, Bld 10B, Shenzhen Bay Eco-Technology Park
No.10, 9th High-tech Southern Avenue
Nanshan District, Shenzhen 518000, China
Tel: +86-755-83438655
E-mail: info@gigadevice.com

Hefei

Qinghua Road 368, Economic & Technological
Development Area, Hefei, Anhui, China
Tel: +86-551-68999899
E-mail: info@gigadevice.com

Xi'an

23F, Building East, ASCENDAS, Tian Gu 7th Road 88,
Hi-tech Industrial Development Zone,
Xi'an, China
Tel: +86-29-88858591
E-mail: info@gigadevice.com

Chengdu

31 / F, block C, OCG International Center, Tianfu 4th
Street, Tianfu new area, Chengdu,China.
Tel: +86-28-89103086
E-mail: info@gigadevice.com

Suzhou

Room 1202, N1 building, 2.5 Industrial Park, No.88
Dongchang Road, SIP, Suzhou, China.
Tel: +86-512-87180588
E-mail: info@gigadevice.com

USA

100 Century Center Ct., Suite 120
San Jose, CA 95112, USA
Tel: +001-408-855-8336
E-mail: info@gigadevice.com

UK

Innovation House
Molly Millars Close, Wokingham
Berkshire RG41 2RX
Tel: +44-7585-707-735
E-mail: info@gigadevice.com

Germany

GmbH
Lindwurmstr. 114, 80337 Munich, Germany
Tel: +49-151-52494892
E-mail: info@gigadevice.com

Korea

217, Yatap Leaders Bld, 42, Jangmi-ro,
Bundang-gu, Seongnam-si
Gyeonggi-do 13496, Korea
Tel: +82-31-701-2408
E-mail: Robert@gigadevice.com

Japan

DSM Shin-Yokohama building 2F,
2-6-3 Shin-Yokohama, Kohoku,
Yokohama 222-0033
Tel: +81-45-534-4102
Fax: +81-45-534-4103
E-mail: info@gigadevice.com

Singapore

Marina Bay Financial Centre Tower 3,
12 Marina Boulevard, #17-01, Singapore
018982
Tel: +65-9765-4231
E-mail: info@gigadevice.com

