

# Common Mode for Signal Line, Telephone Sets, Through-Hole Type, ST Series

## Overview

The KEMET ST coils are common mode chokes with a wide variety of characteristics. These through-hole toroidal coils are designed with our proprietary ferrite cores and are suitable for noise countermeasure in DC signal line circuits.

## Applications

- Audio-visual equipment
- Office automation equipment
- Digital appliances
- Home appliances
- Power supplies
- Telephone Sets

## Benefits

- Proprietary Manganese-Zinc (Mn-Zn) and Nickel-Zinc (Ni-Zn) ferrite materials
- Withstanding voltage: 500 VDC (one minute, between lines)
- Insulation resistance: more than 10 MΩ (250 VDC, between lines, except ST-\*\*\*A type 100 VDC)
- Operating temperature range from -20°C to +75°C (except ST-\*\*\*A type to +65°C)
- UL94 V-0 flame retardant rated terminal base
- UL94 V-2 flame retardant rated cap
- RoHS Compliant



## Part Number System

ST-	1	01	F
Series	Core Material	Core Size	Core Orientation
ST-	1 = Mn-Zn 2 = Ni-Zn	01 = 12 mm 02 = 10 mm 04 = 10 mm	Blank = Horizontal, bare winding A = Vertical A-4 = Vertical F2 = Horizontal F4 = Horizontal A1 = Horizontal A3 = Horizontal A4 = Horizontal

## Dimensions – Millimeters

Part Number	Dimensions - Millimeters	Circuit Diagram
<p>ST-101 ST-201</p>		
<p>ST-202</p>		
<p>ST-202S</p>		
<p>ST-101A ST-201A ST-202A</p>		

**Dimensions – Millimeters cont.**

Part Number	Dimensions - Millimeters	Bottom View	Circuit Diagram
ST-101F2			
ST-101F4			
ST-104A4			
ST-204A1 ST-204A3 ST-204A4			

## Environmental Compliance

All KEMET DC line filters are RoHS Compliant.



## Performance Characteristics

Item	Performance Characteristics
Rated Voltage	50 VDC
Withstanding Voltage	500 VDC (1 minute, between lines)
Insulation Resistance	> 10 MΩ t 250 VDC (between lines) except ST-***A: > 10 MΩ at 100 VDC (between lines)"
Rated Current Range	200 – 1,000 mA
Frequency Range	0.5 ~ 7.0 – 7.0 ~ 100.0 MHz
Impedance Range	0.25 – 60.00 kΩ minimum
Rated DC Resistance Range	35 – 3,500 mΩ maximum
Operating Temperature Range	-20°C to +75°C (not including self-temperature rise) except ST-***A: -20°C to +65°C (not including self-temperature rise)
Operating Temperature Range	-25°C to +70°C (not including self-temperature rise)

**Table 1 – Ratings & Part Number Reference**

Part Number	Frequency Range (MHz)	Impedance (kΩ) Minimum	Rated Voltage DC (V)	Rated Current (mA)	DC Resistance/Line (Ω) Maximum	Frequency Range	Weight (g)
ST-101	0.5 ~ 7.0	3.00 at 0.5 MHz	50	200	180.00	AM band	3.73
ST-201	7.0 ~ 40.0	1.50 at 7.0 MHz	50	200	100.00	FM band	2.66
ST-202	7.0 ~ 100.0	0.60 at 100.0 MHz	50	1,000	40.00	FM band	1.27
ST-202S	7.0. ~ 100.0	0.60 at 100.0 MHz	50	1,000	35.00	FM band	1.27
ST-101A	0.5 ~ 7.0	3.00 at 0.5 MHz	50	200	250.00	AM band	4.53
ST-201A	7.0 ~ 40.0	1.50 at 7.0 MHz	50	200	150.00	FM band	3.63
ST-202A	7.0 ~ 100.0	0.60 at 100.0 MHz	50	1,000	50.00	FM band	3.37
ST-101F2	0.5 ~ 7.0	40.00 at 600.0 kHz	50	200	2.70	AM band	2.90
ST-101F4	0.5 ~ 7.0	60.00 at 600.0 kHz	50	200	3.50	AM band	3.33
ST-104A4	0.5 ~ 7.0	3.00 at 0.5 MHz	50	500	0.36	AM band	2.70
ST-204A1	7.0 ~ 100.0	0.25 at 10.0 MHz	50	500	0.10	FM band	2.13
ST-204A3	7.0 ~ 40.0	1.00 at 7.0 MHz	50	500	0.17	FM band	2.31
ST-204A4	7.0 ~ 40.0	0.60 at 7.0 MHz REF	50	500	0.12	FM band	2.11

## Installation & Design Examples

### Installation Examples

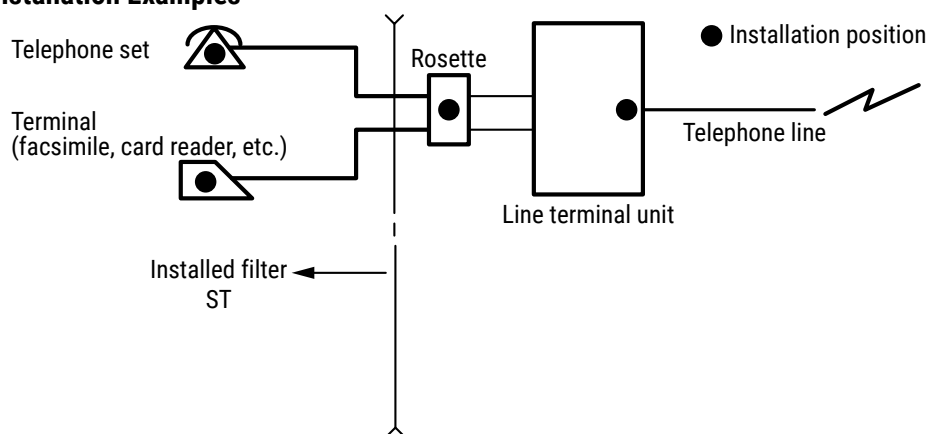

### Design Examples

- ① Installation at rosette or circuit input/output
- ② Insertion in Driver/Receiver circuit in telephone

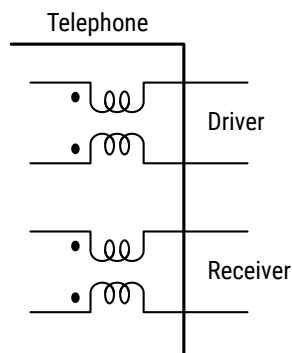
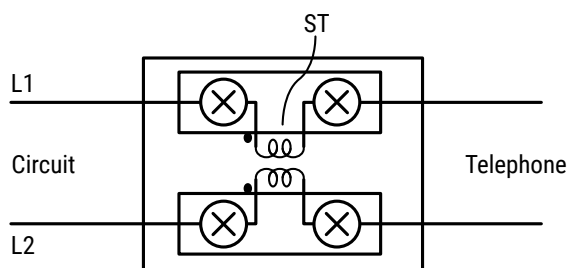

## Frequency Characteristics

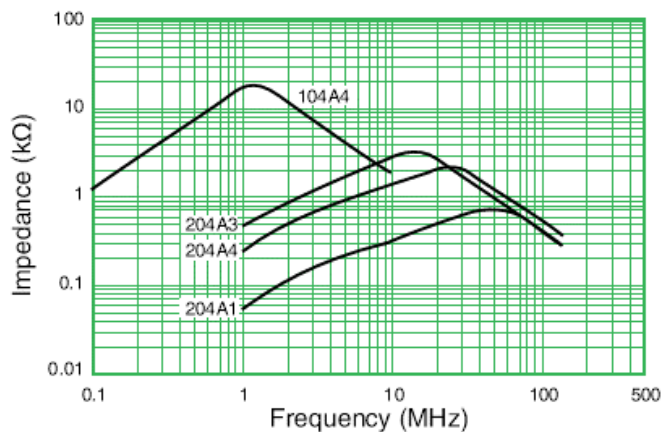
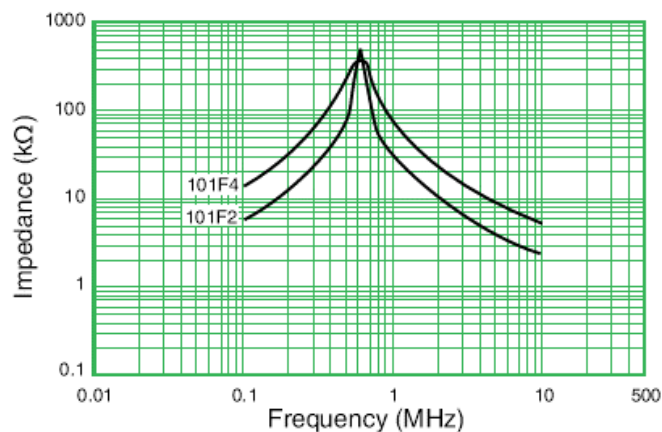
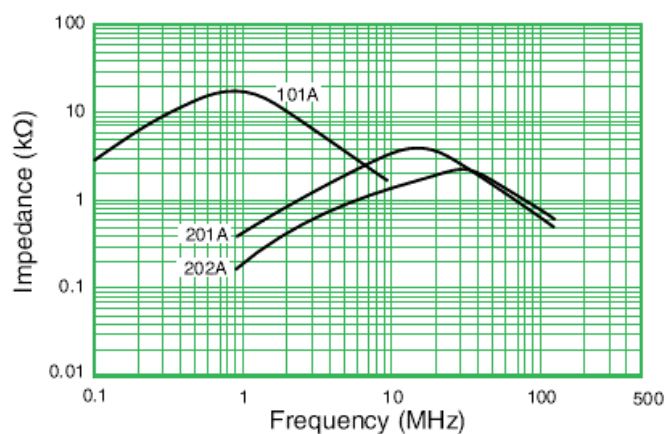
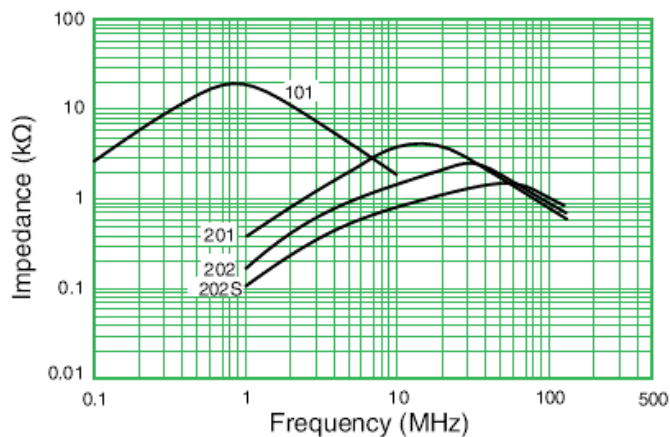

## Packaging

Part Type	Packaging Type	Pieces per Box
ST-101	Tray	1,200
ST-201		
ST-202		
ST-202S	Bulk	6,000
ST-101A	Tray	480
ST-201A		
ST-202A		
ST-101F2		
ST-101F4		
ST-104A4		
ST-204A1	4,800	
ST-204A3		
ST-204A4		

## Handling Precautions

### Precautions for product storage

DC Line Filters should be stored in normal working environments. While the chokes themselves are quite robust in other environments, solderability will be degraded by exposure to high temperatures, high humidity, corrosive atmospheres, and long term storage.

KEMET recommends that maximum storage temperature not exceed 40°C and maximum storage humidity not exceed 70% relative humidity. Atmospheres should be free of chlorine and sulfur bearing compounds. Temperature fluctuations should be minimized to avoid condensation on the parts. Do not store near strong magnetic fields, as this might magnetize the product.

For optimized solderability, DC line filter stock should be used promptly, preferably within six months of receipt.

### Product temperature rise values

The values listed for temperature rise are the result of self-heating in wires when the rated current (commercial frequency) is applied. When using, check and evaluate the value of the core temperature rise under actual operating conditions.

---

## Export Control

### For customers in Japan

For products that are controlled items subject to the “Foreign Exchange and Foreign Trade Law” of Japan, the export license specified by the law is required for export.

### For customers outside Japan

DC Line Filters should not be used or sold for use in the development, production, stockpiling or utilization of any conventional weapons or mass-destructive weapons (nuclear weapons, chemical or biological weapons, or missiles) or any other weapons.

## KEMET Electronics Corporation Sales Offices

For a complete list of our global sales offices, please visit [www.kemet.com/sales](http://www.kemet.com/sales).

---

### Disclaimer

YAGEO Corporation and its affiliates do not recommend the use of commercial or automotive grade products for high reliability applications or manned space flight.

All product specifications, statements, information and data (collectively, the "Information") in this datasheet are subject to change. The customer is responsible for checking and verifying the extent to which the Information contained in this publication is applicable to an order at the time the order is placed. All Information given herein is believed to be accurate and reliable, but it is presented without guarantee, warranty, or responsibility of any kind, expressed or implied.

Statements of suitability for certain applications are based on KEMET Electronics Corporation's ("KEMET") knowledge of typical operating conditions for such applications, but are not intended to constitute – and KEMET specifically disclaims – any warranty concerning suitability for a specific customer application or use. The Information is intended for use only by customers who have the requisite experience and capability to determine the correct products for their application. Any technical advice inferred from this Information or otherwise provided by KEMET with reference to the use of KEMET's products is given gratis, and KEMET assumes no obligation or liability for the advice given or results obtained.

Although KEMET designs and manufactures its products to the most stringent quality and safety standards, given the current state of the art, isolated component failures may still occur. Accordingly, customer applications which require a high degree of reliability or safety should employ suitable designs or other safeguards (such as installation of protective circuitry or redundancies) in order to ensure that the failure of an electrical component does not result in a risk of personal injury or property damage.

Although all product-related warnings, cautions and notes must be observed, the customer should not assume that all safety measures are indicated or that other measures may not be required.

When providing KEMET products and technologies contained herein to other countries, the customer must abide by the procedures and provisions stipulated in all applicable export laws and regulations, including without limitation the International Traffic in Arms Regulations (ITAR), the US Export Administration Regulations (EAR) and the Japan Foreign Exchange and Foreign Trade Act.

*KEMET is a registered trademark of KEMET Electronics Corporation.*