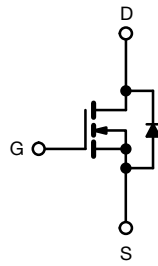
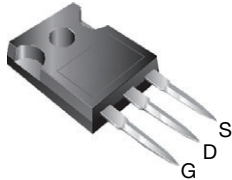

EL Series Power MOSFET

TO-247AC

N-Channel MOSFET

FEATURES

- Low figure-of-merit (FOM) $R_{on} \times Q_g$
- Low input capacitance (C_{iss})
- Reduced switching and conduction losses
- Ultra low gate charge (Q_g)
- Avalanche energy rated (UIS)
- Material categorization: for definitions of compliance please see www.vishay.com/doc?99912

RoHS
 COMPLIANT
 HALOGEN
FREE

APPLICATIONS

- Server and telecom power supplies
- Switch mode power supplies (SMPS)
- Power factor correction power supplies (PFC)
- Lighting
 - High-intensity discharge (HID)
 - Fluorescent ballast lighting
- Industrial
 - Welding
 - Induction heating
 - Motor drives
 - Battery chargers
 - Renewable energy
 - Solar (PV inverters)

PRODUCT SUMMARY

V_{DS} (V) at T_J max.	650	
$R_{DS(on)}$ typ. (Ω) at 25 °C	$V_{GS} = 10$ V	0.53
Q_g max. (nC)	222	
Q_{gs} (nC)	25	
Q_{gd} (nC)	36	
Configuration	Single	

ORDERING INFORMATION

Package	TO-247AC
Lead (Pb)-free and halogen-free	SiHG47N60AEL-GE3

ABSOLUTE MAXIMUM RATINGS ($T_C = 25$ °C, unless otherwise noted)

PARAMETER	SYMBOL	LIMIT	UNIT
Drain-source voltage	V_{DS}	600	V
Gate-source voltage	V_{GS}	± 30	
Continuous drain current ($T_J = 150$ °C)	V_{GS} at 10 V	$T_C = 25$ °C	A
		$T_C = 100$ °C	
Pulsed drain current ^a	I_{DM}	140	
Linear derating factor		3.0	W/°C
Single pulse avalanche energy ^b	E_{AS}	691	mJ
Maximum power dissipation	P_D	379	W
Operating junction and storage temperature range	T_J, T_{stg}	-55 to +150	°C
Reverse diode dv/dt ^d	dv/dt	50	V/ns
Soldering recommendations (peak temperature) ^c	For 10 s	260	°C

Notes

- Repetitive rating; pulse width limited by maximum junction temperature
- $V_{DD} = 120$ V, starting $T_J = 25$ °C, $L = 28.2$ mH, $R_g = 25$ Ω , $I_{AS} = 7.0$ A
- 1.6 mm from case
- $I_{SD} \leq I_D$, $di/dt = 100$ A/ μ s, starting $T_J = 25$ °C



THERMAL RESISTANCE RATINGS				
PARAMETER	SYMBOL	TYP.	MAX.	UNIT
Maximum junction-to-ambient	R _{thJA}	-	40	°C/W
Maximum junction-to-case (drain)	R _{thJC}	-	0.33	

SPECIFICATIONS (T _J = 25 °C, unless otherwise noted)									
PARAMETER	SYMBOL	TEST CONDITIONS		MIN.	TYP.	MAX.	UNIT		
Static									
Drain-source breakdown voltage	V _{DS}	V _{GS} = 0 V, I _D = 250 μA		600	-	-	V		
V _{DS} temperature coefficient	ΔV _{DS} /T _J	Reference to 25 °C, I _D = 1 mA		-	0.67	-	V/°C		
Gate-source threshold Voltage (N)	V _{GS(th)}	V _{DS} = V _{GS} , I _D = 250 μA		2.0	-	4.0	V		
Gate-source leakage	I _{GSS}	V _{GS} = ± 20 V		-	-	± 100	nA		
		V _{GS} = ± 30 V		-	-	± 1	μA		
Zero gate voltage drain current	I _{DSS}	V _{DS} = 600 V, V _{GS} = 0 V		-	-	1	μA		
		V _{DS} = 480 V, V _{GS} = 0 V, T _J = 125 °C		-	-	10			
Drain-source on-state resistance	R _{DS(on)}	V _{GS} = 10 V	I _D = 23.5 A	-	0.053	0.065	Ω		
Forward transconductance ^a	g _{fs}	V _{DS} = 20 V, I _D = 23.5 A		-	29	-	S		
Dynamic									
Input capacitance	C _{iss}	V _{GS} = 0 V, V _{DS} = 100 V, f = 1 MHz		-	4600	-	pF		
Output capacitance	C _{oss}			-	186	-			
Reverse transfer capacitance	C _{rss}			-	7	-			
Effective output capacitance, energy related ^a	C _{o(er)}			V _{DS} = 0 V to 480 V, V _{GS} = 0 V		-		121	-
Effective output capacitance, time related ^b	C _{o(tr)}			V _{DS} = 0 V to 480 V, V _{GS} = 0 V		-		635	-
Total gate charge	Q _g	V _{GS} = 10 V	I _D = 23.5 A, V _{DS} = 480 V	-	111	222	nC		
Gate-source charge	Q _{gs}			-	25	-			
Gate-drain charge	Q _{gd}			-	36	-			
Turn-on delay time	t _{d(on)}	V _{DD} = 480 V, I _D = 23.5 A, V _{GS} = 10 V, R _g = 22 Ω		-	55	110	ns		
Rise time	t _r			-	65	130			
Turn-off delay time	t _{d(off)}			-	267	534			
Fall time	t _f			-	71	142			
Gate input resistance	R _g			f = 1 MHz, open drain		0.3		0.7	1.4
Drain-Source Body Diode Characteristics									
Continuous source-drain diode current	I _S	MOSFET symbol showing the integral reverse p - n junction diode 		-	-	47	A		
Pulsed diode forward current	I _{SM}			-	-	140			
Diode forward voltage	V _{SD}	T _J = 25 °C, I _S = 23.5 A, V _{GS} = 0 V		-	-	1.2	V		
Reverse recovery time	t _{rr}	T _J = 25 °C, I _F = I _S = 23.5 A, di/dt = 100 A/μs, V _R = 400 V		-	437	874	ns		
Reverse recovery charge	Q _{rr}			-	8.6	17.2	μC		
Reverse recovery current	I _{RRM}			-	37	-	A		

Notes

- a. C_{oss(er)} is a fixed capacitance that gives the same energy as C_{oss} while V_{DS} is rising from 0 % to 80 % V_{DSS}
- b. C_{oss(tr)} is a fixed capacitance that gives the same charging time as C_{oss} while V_{DS} is rising from 0 % to 80 % V_{DSS}

TYPICAL CHARACTERISTICS (25 °C, unless otherwise noted)

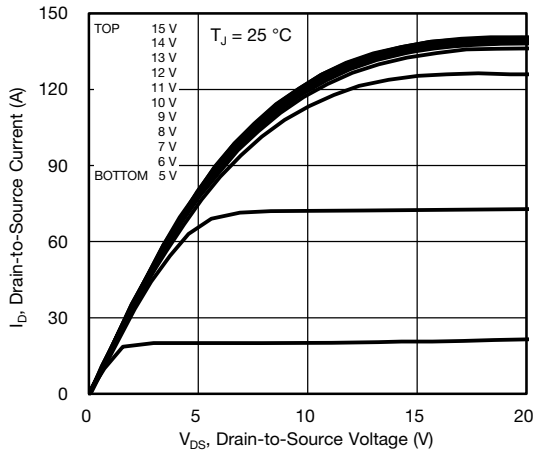

Fig. 1 - Typical Output Characteristics

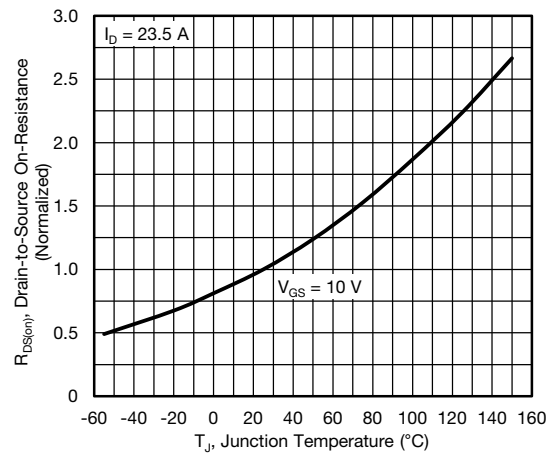

Fig. 4 - Normalized On-Resistance vs. Temperature

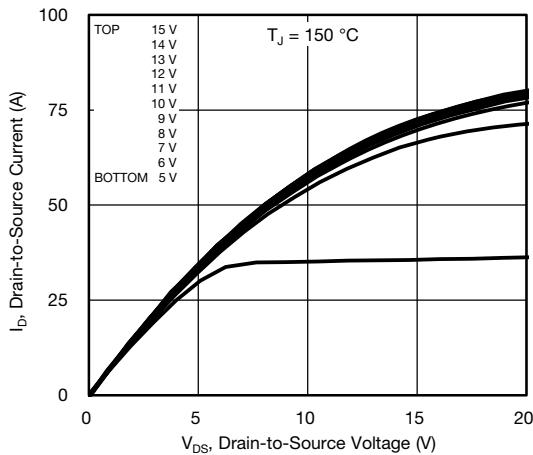

Fig. 2 - Typical Output Characteristics

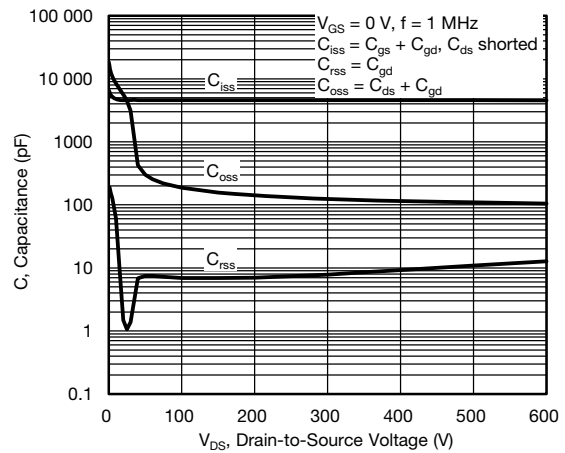

Fig. 5 - Typical Capacitance vs. Drain-to-Source Voltage

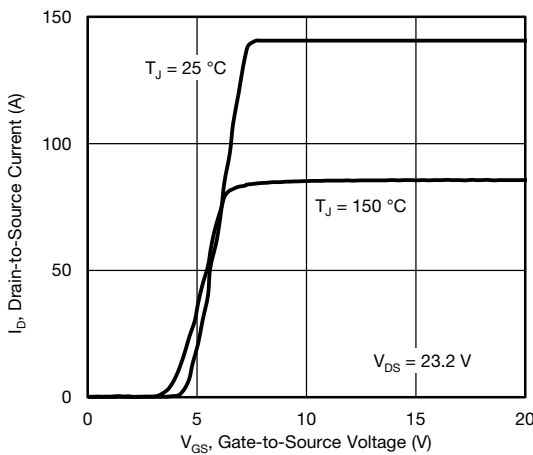

Fig. 3 - Typical Transfer Characteristics

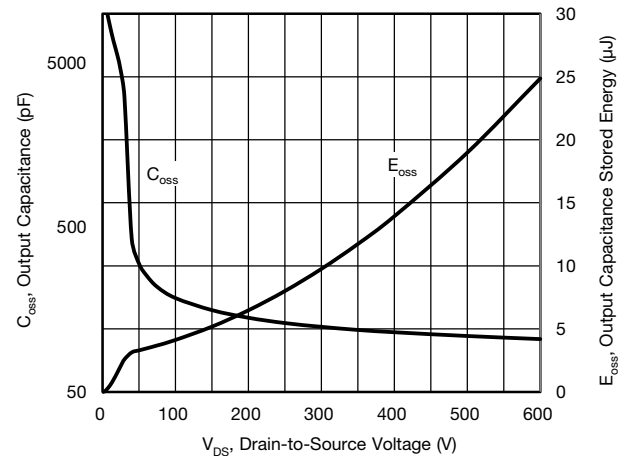

Fig. 6 - C_{oss} and E_{oss} vs. V_{DS}

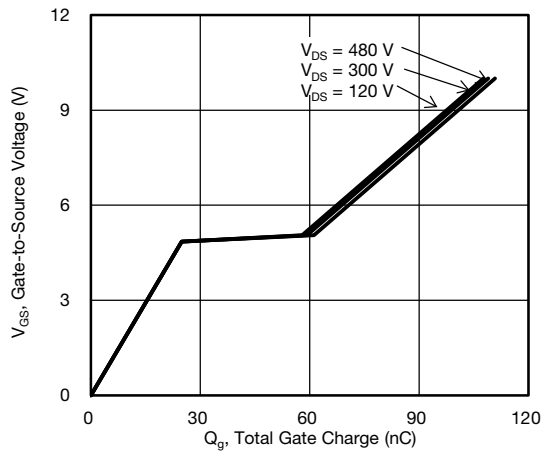

Fig. 7 - Typical Gate Charge vs. Gate-to-Source Voltage

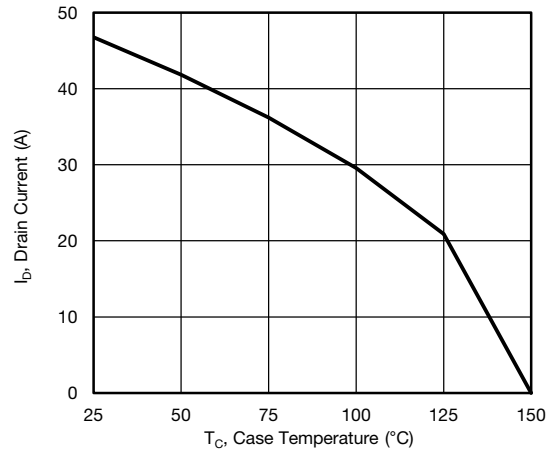

Fig. 10 - Maximum Drain Current vs. Case Temperature

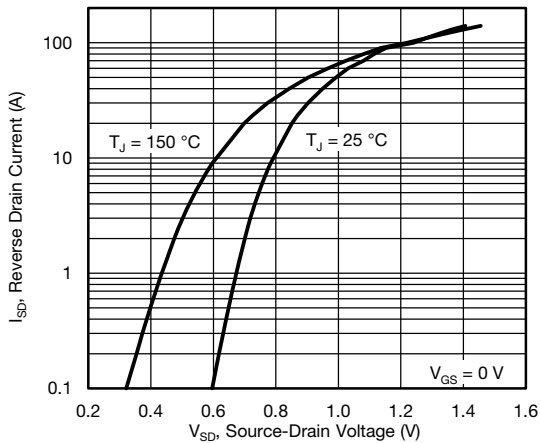

Fig. 8 - Typical Source-Drain Diode Forward Voltage

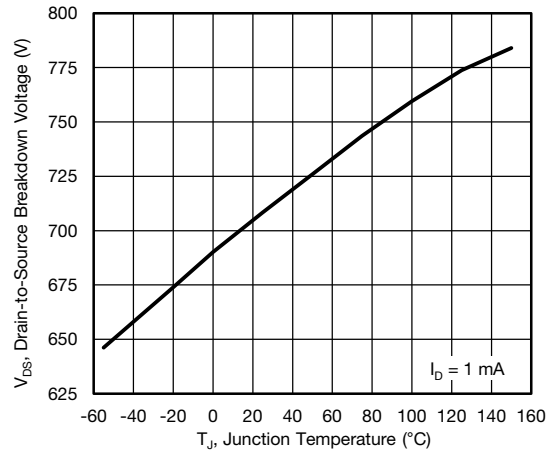

Fig. 11 - Temperature vs. Drain-to-Source Voltage

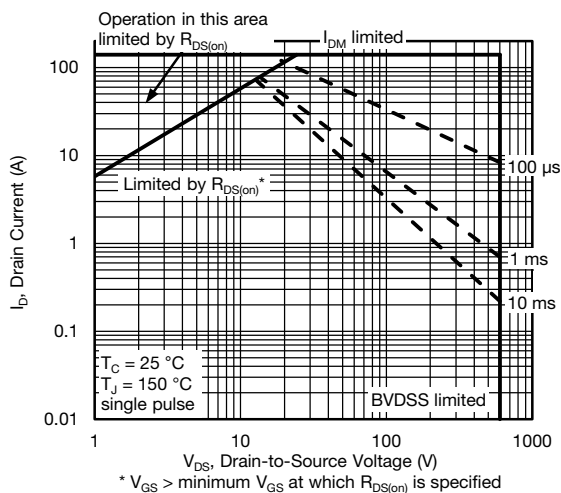

Fig. 9 - Maximum Safe Operating Area

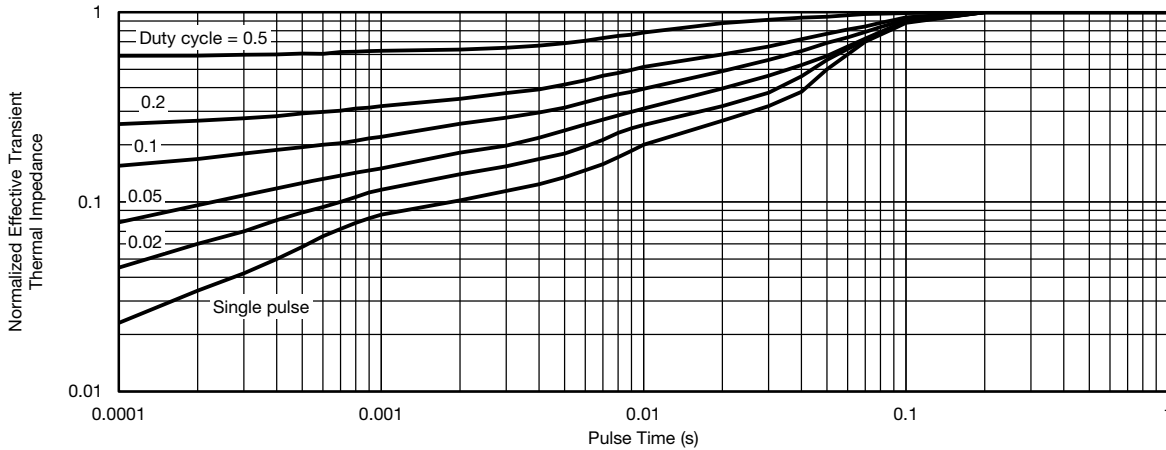

Fig. 12 - Normalized Thermal Transient Impedance, Junction-to-Case



Fig. 13 - Switching Time Test Circuit

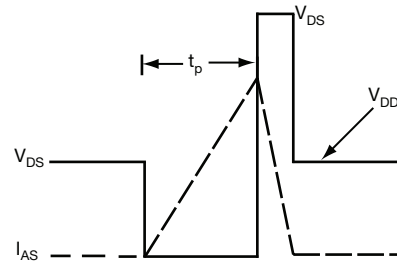

Fig. 16 - Unclamped Inductive Waveforms

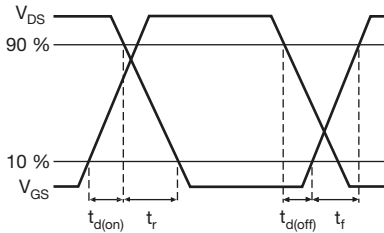

Fig. 14 - Switching Time Waveforms

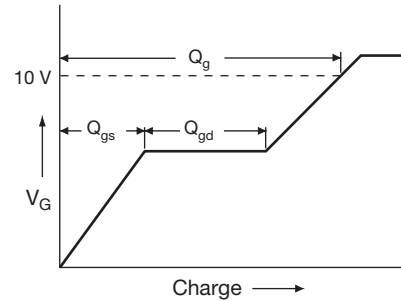

Fig. 17 - Basic Gate Charge Waveform

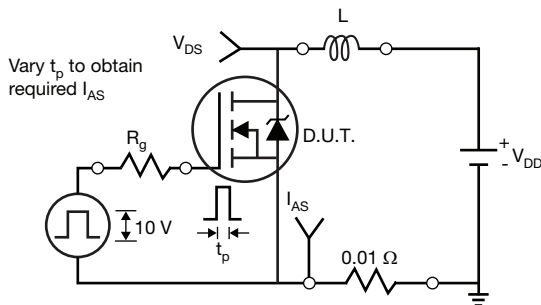
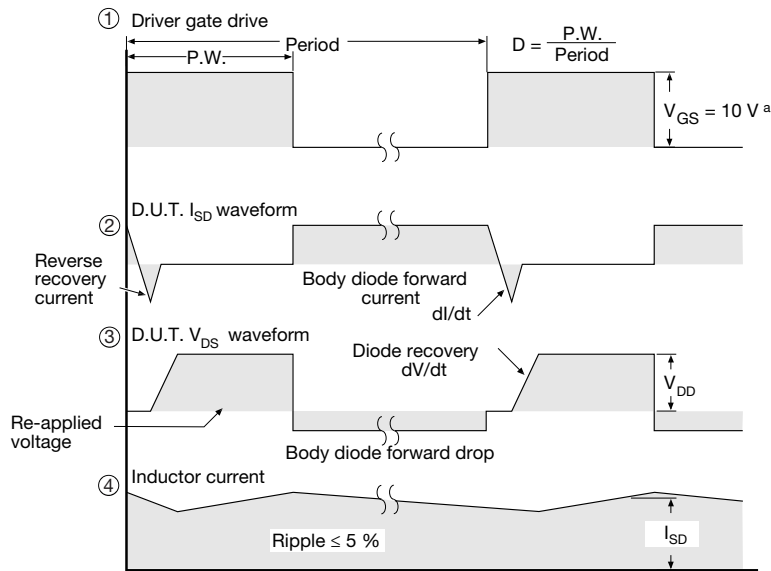
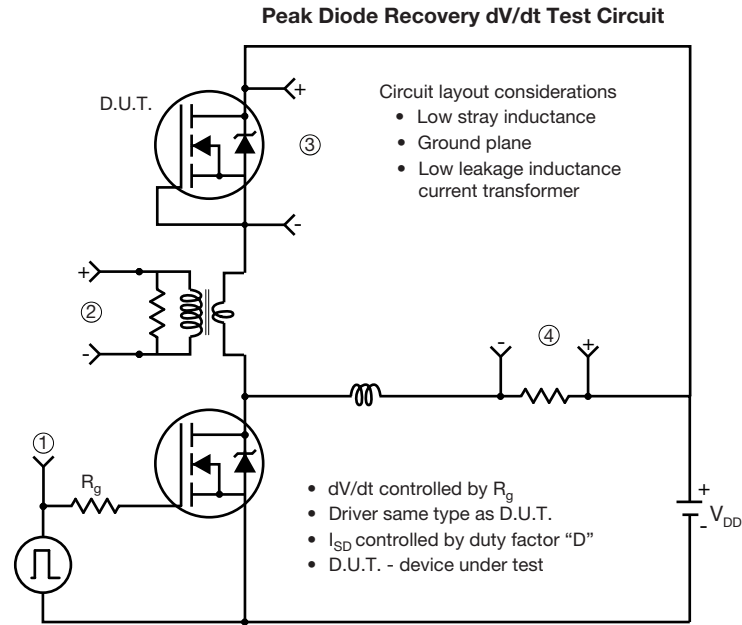

Fig. 15 - Unclamped Inductive Test Circuit



Fig. 18 - Gate Charge Test Circuit



Note
a. $V_{GS} = 5\text{ V}$ for logic level devices

Fig. 19 - For N-Channel

Vishay Siliconix maintains worldwide manufacturing capability. Products may be manufactured at one of several qualified locations. Reliability data for Silicon Technology and Package Reliability represent a composite of all qualified locations. For related documents such as package/tape drawings, part marking, and reliability data, see www.vishay.com/ppg?92081.



Disclaimer

ALL PRODUCT, PRODUCT SPECIFICATIONS AND DATA ARE SUBJECT TO CHANGE WITHOUT NOTICE TO IMPROVE RELIABILITY, FUNCTION OR DESIGN OR OTHERWISE.

Vishay Intertechnology, Inc., its affiliates, agents, and employees, and all persons acting on its or their behalf (collectively, "Vishay"), disclaim any and all liability for any errors, inaccuracies or incompleteness contained in any datasheet or in any other disclosure relating to any product.

Vishay makes no warranty, representation or guarantee regarding the suitability of the products for any particular purpose or the continuing production of any product. To the maximum extent permitted by applicable law, Vishay disclaims (i) any and all liability arising out of the application or use of any product, (ii) any and all liability, including without limitation special, consequential or incidental damages, and (iii) any and all implied warranties, including warranties of fitness for particular purpose, non-infringement and merchantability.

Statements regarding the suitability of products for certain types of applications are based on Vishay's knowledge of typical requirements that are often placed on Vishay products in generic applications. Such statements are not binding statements about the suitability of products for a particular application. It is the customer's responsibility to validate that a particular product with the properties described in the product specification is suitable for use in a particular application. Parameters provided in datasheets and / or specifications may vary in different applications and performance may vary over time. All operating parameters, including typical parameters, must be validated for each customer application by the customer's technical experts. Product specifications do not expand or otherwise modify Vishay's terms and conditions of purchase, including but not limited to the warranty expressed therein.

Except as expressly indicated in writing, Vishay products are not designed for use in medical, life-saving, or life-sustaining applications or for any other application in which the failure of the Vishay product could result in personal injury or death. Customers using or selling Vishay products not expressly indicated for use in such applications do so at their own risk. Please contact authorized Vishay personnel to obtain written terms and conditions regarding products designed for such applications.

No license, express or implied, by estoppel or otherwise, to any intellectual property rights is granted by this document or by any conduct of Vishay. Product names and markings noted herein may be trademarks of their respective owners.

Mouser Electronics

Authorized Distributor

Click to View Pricing, Inventory, Delivery & Lifecycle Information:

Vishay:

[SIHG47N60AEL-GE3](#)