



**SMD LED**  
**Product Data Sheet**  
LTST-006GEBW-P2

Spec No. :DS35-2019-0093  
Effective Date: 06/07/2023  
Revision: B

**LITE-ON DCC**

**RELEASE**

**BNS-OD-FC001/A4**

## SMD LED LTST-006GEBW-P2

### 1. Description

SMD LEDs from Lite-On are available in miniature sizes and special configurations for automated PC board assembly and space-sensitive applications. These SMD LEDs are suitable for use in a wide variety of electronic equipment, including cordless and cellular phones, notebook computers, network systems, home appliances, and indoor signboard applications.

#### 1.1 Features

- Meet ROHS
- Package in 12mm tape on 7" diameter reels
- EIA STD package
- I.C. compatible
- Compatible with automatic placement equipment
- Compatible with infrared reflow solder process
- Preconditioning: accelerate to JEDEC level 3

#### 1.2 Applications

- Telecommunication, Office automation, home appliances, industrial equipment
- Status indicator
- Signal and Symbol Luminary
- Front panel backlighting

### 2. Package Dimensions

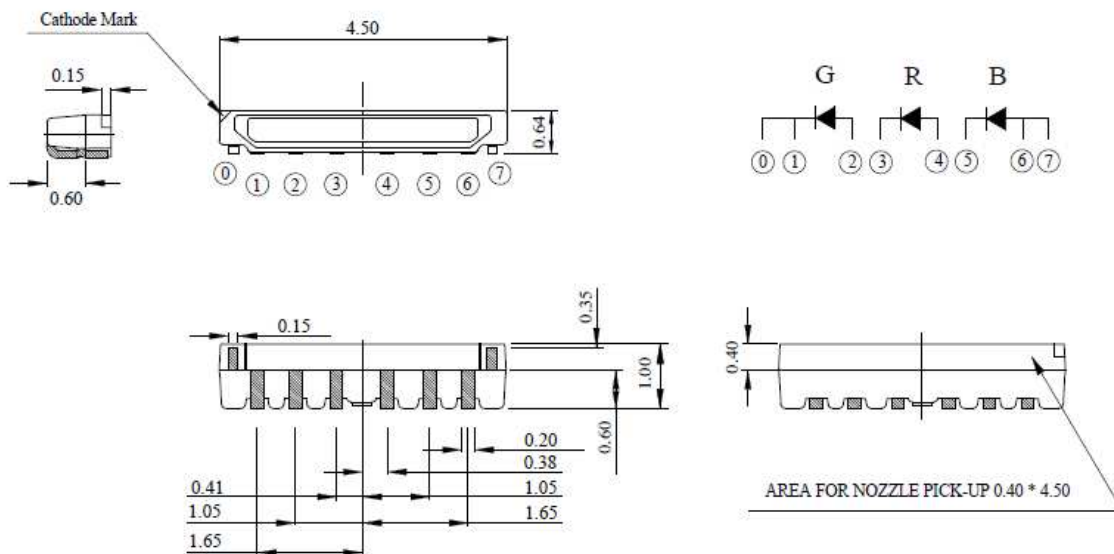

Part No.	Lens Color	Source Color	Pin Assignment
LTST-006GEBW-P2	White Diffused	InGaN Green	(0,1) , 2
		AllnGaP Red	3 , 4
		InGaN Blue	5 , (6,7)

#### Notes:

1. All dimensions are in millimeters.
2. Tolerance is  $\pm 0.1$  mm (.004") unless otherwise noted.

## SMD LED LTST-006GEBW-P2

### 3. Rating and Characteristics

#### 3.1 Absolute Maximum Ratings at Ta=25°C

Parameter	LTST-006GEBW-P2			Unit
	Green	Red	Blue	
Power Dissipation	93	72	93	mW
Peak Forward Current (1/10 Duty Cycle, 0.1ms Pulse Width)	100	80	100	mA
DC Forward Current	30	30	30	mA
Operating Temperature Range	-40°C to + 85°C			
Storage Temperature Range	-40°C to + 100°C			

#### 3.2 Suggest IR Reflow Condition for Pb Free Process:

IR-Reflow Soldering Profile for lead free soldering (Acc. to J-STD-020B)

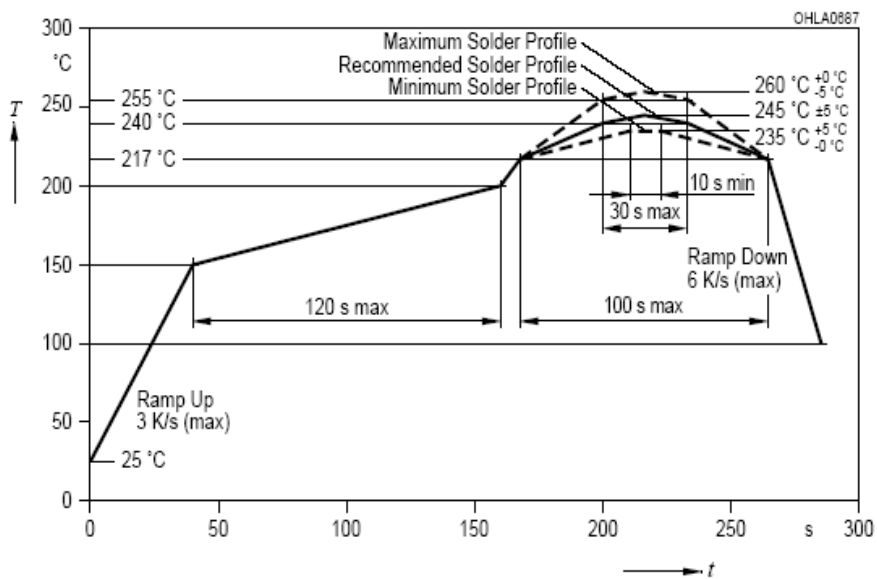

## SMD LED LTST-006GEBW-P2

### 3.3 Electrical / Optical Characteristics at Ta=25°C

Parameter	Symbol	LTST-006GEBW-P2				Test Condition	Unit.
			Green	Red	Blue		
Luminous Flux <sup>1</sup>	$\Phi_v$	Min.	1.15	0.47	0.23	G: I <sub>F</sub> = 5mA R: I <sub>F</sub> = 5mA B: I <sub>F</sub> = 5mA	lm
		Typ.	-	-	-		
		Max.	2.40	0.95	0.48		
Viewing Angle	2 $\theta_{1/2}$	Typ.	120			-	deg
Dominant Wavelength <sup>2</sup>	$\lambda_d$	Min.	520	617	465	G: I <sub>F</sub> = 5mA R: I <sub>F</sub> = 5mA B: I <sub>F</sub> = 5mA	nm
		Max.	532	630	477		
Color Coordinate	$\lambda_d(\text{Min.})$	Typ.x	0.2650			G: I <sub>F</sub> = 5mA R: I <sub>F</sub> = 5mA B: I <sub>F</sub> = 5mA	-
		Typ.y	0.3020				
Forward Voltage <sup>3</sup>	V <sub>F</sub>	Min.	2.10	1.50	2.10	G: I <sub>F</sub> = 5mA R: I <sub>F</sub> = 5mA B: I <sub>F</sub> = 5mA	V
		Typ.	-	-	-		
		Max.	3.10	2.40	3.10		
Spectral Line Half-Width	$\Delta\lambda$	Typ.	35	20	25	-	nm
Reverse Current	I <sub>R</sub>	Max.	10			V <sub>R</sub> = 5V	$\mu$ A

#### Notes:

1. Tolerance of Luminous Flux is +/- 10%
2. Tolerance of Dominant Wavelength is +/- 1nm
3. Tolerance of Forward Voltage is +/- 0.1V
4. Caution in ESD:  
Static Electricity and surge damages the LED. It is recommended to use a wrist band or anti-electrostatic glove when handling the LED. All devices, equipment and machinery must be properly grounded.
5. CAS140B is the test standard for the chromaticity coordinates IV. For each die/channel.

## SMD LED LTST-006GEBW-P2

### 4. Bin Code List

#### 4.1 IV Rank

Luminous Spec. Table (I <sub>f</sub> : R=5mA, G=5mA, B=5mA)				
Bin Code	Luminous Flux (lm)		Luminous Intensity (mcd)	
	Min.	Max.	Min.	Max.
V1	1.88	2.65	640	900
V2	2.65	3.80	900	1300

Tolerance on each Luminous Intensity bin is +/- 10%, and Luminous Intensity(mcd) is for reference.

#### 4.2 CIE Rank

Color Bin Table (I <sub>f</sub> : R=5mA, G=5mA, B=5mA)											
Bin Code	Color Bin Limits					Bin Code	Color Bin Limits				
	CIE-	Point1	Point2	Point3	Point4		CIE-	Point1	Point2	Point3	Point4
J5	x	0.2250	0.2450	0.2450	0.2250	L5	x	0.2650	0.2850	0.2850	0.2650
	y	0.2600	0.2660	0.2860	0.2800		y	0.2720	0.2780	0.2980	0.2920
J6	x	0.2250	0.2450	0.2450	0.2250	L6	x	0.2650	0.2850	0.2850	0.2650
	y	0.2800	0.2860	0.3060	0.3000		y	0.2920	0.2980	0.3180	0.3120
J7	x	0.2250	0.2450	0.2450	0.2250	L7	x	0.2650	0.2850	0.2850	0.2650
	y	0.3000	0.3060	0.3260	0.3200		y	0.3120	0.3180	0.3380	0.3320
K5	x	0.2450	0.2650	0.2650	0.2450	M5	x	0.2850	0.3050	0.3050	0.2850
	y	0.2660	0.2720	0.2920	0.2860		y	0.2780	0.2840	0.3040	0.2980
K6	x	0.2450	0.2650	0.2650	0.2450	M6	x	0.2850	0.3050	0.3050	0.2850
	y	0.2860	0.2920	0.3120	0.3060		y	0.2980	0.3040	0.3240	0.3180
K7	x	0.2450	0.2650	0.2650	0.2450	M7	x	0.2850	0.3050	0.3050	0.2850
	y	0.3060	0.3120	0.3320	0.3260		y	0.3180	0.3240	0.3440	0.3380

Tolerance on each Hue bin (x, y) bin is +/- 0.01

#### C.I.E. 1931 Chromaticity Diagram

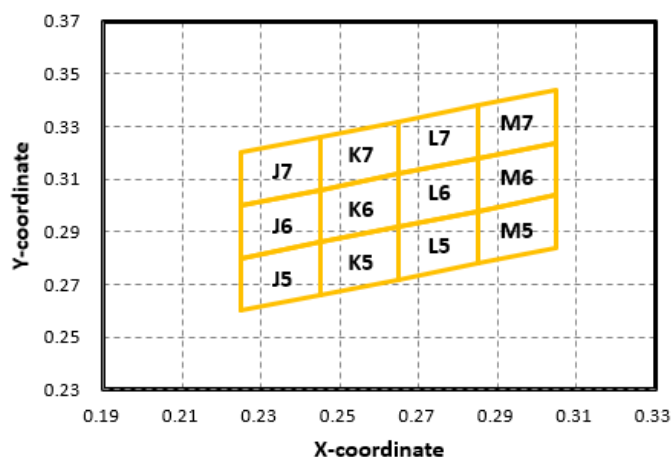

**SMD LED  
LTST-006GEBW-P2**

**5. Typical Electrical / Optical Characteristics Curves.**

(25°C Ambient Temperature Unless Otherwise Noted)

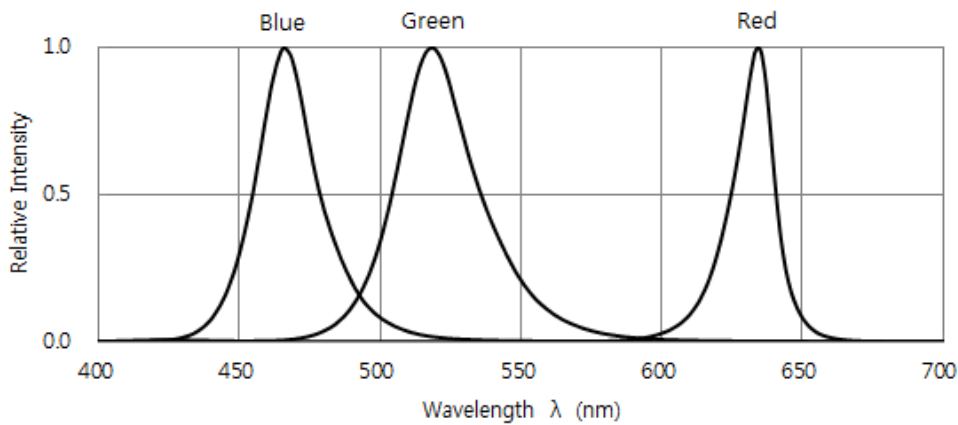

**Fig. 1 RELATIVE INTENSITY VS. WAVELENGTH**

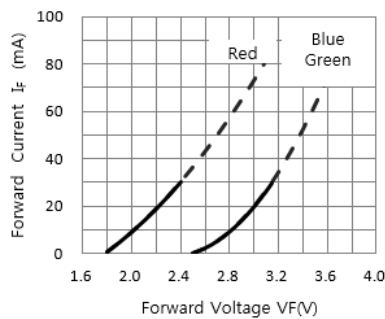

**Fig. 2 FORWARD CURRENT VS. FORWARD VOLTAGE**

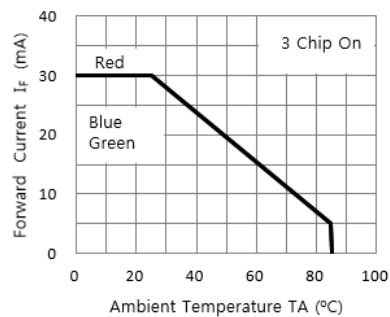

**Fig. 3 FORWARD CURRENT VS. DERATING CURVE**

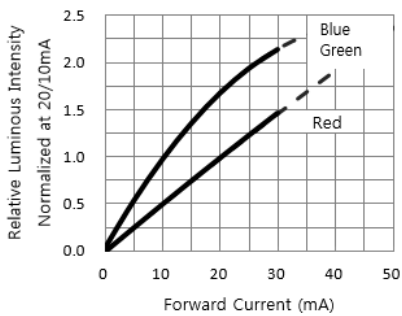

**Fig. 4 RELATIVE LUMINOUS INTENSITY VS. FORWARD CURRENT**

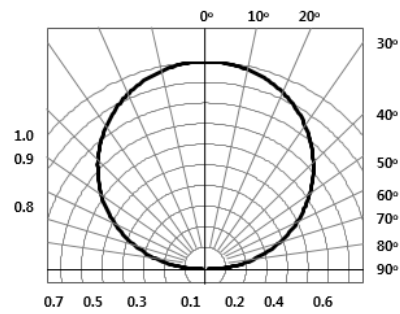

**Fig. 5 Spatial Distribution**

**SMD LED  
LTST-006GEBW-P2**

**6. User Guide**

**6.1 Cleaning**

Do not use unspecified chemical liquid to clean LED they could harm the package. If cleaning is necessary, immerse the LED in ethyl alcohol or isopropyl alcohol at normal temperature for less one minute.

**6.2 Recommend Printed Circuit Board Attachment Pad**

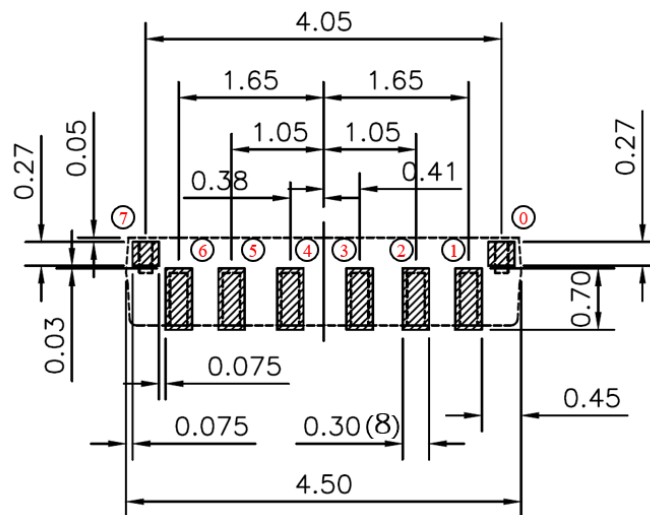

**6.3 Package Dimensions of Tape and Reel**

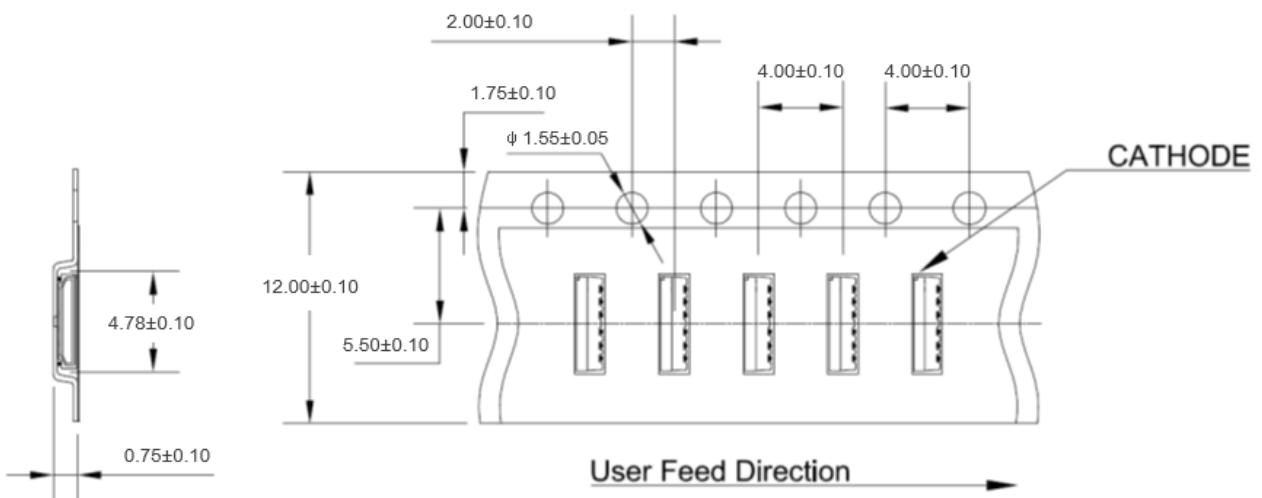

**Note:**

1. All dimensions are in millimeters (inches).

**SMD LED  
LTST-006GEBW-P2**

6.4 Package Dimensions of Reel

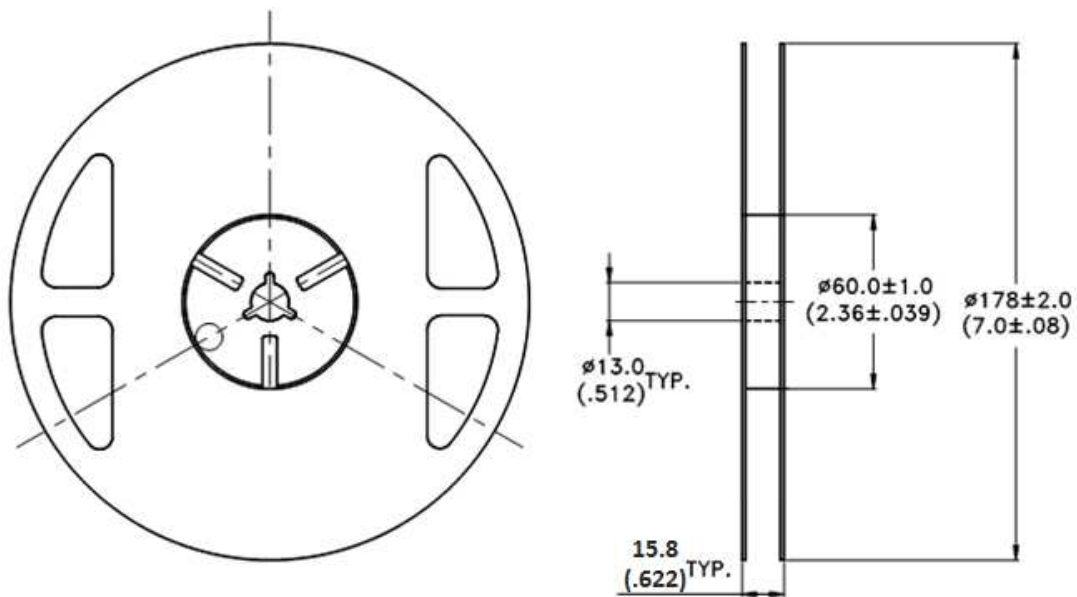

Notes:

1. Empty component pockets sealed with top cover tape.
2. 7 inch reel 4000 pieces per reel.
3. Minimum packing quantity is 500 pieces for remainders.
4. The maximum number of consecutive missing lamps is two.
5. In accordance with EIA-481-1-B specifications.



## SMD LED LTST-006GEBW-P2

### 7. Cautions

#### 7.1 Application

The LEDs described here are intended to be used for ordinary electronic equipment (such as office equipment, communication equipment and household applications). Consult Liteon's Sales in advance for information on applications in which exceptional reliability is required, particularly when the failure or malfunction of the LEDs may directly jeopardize life or health (such as in aviation, transportation, traffic control equipment, medical and life support systems and safety devices).

#### 7.2 Storage

The package is sealed:

The LEDs should be stored at 30°C or less and 70%RH or less. And the LEDs are limited to use within one year, while the LEDs is packed in moisture-proof package with the desiccants inside.

The package is opened:

The storage ambient for the LEDs should not exceed 30°C temperature and 60% relative humidity.

It is recommended that LEDs out of their original packaging are IR-reflowed within 168hrs.

For extended storage out of their original packaging, it is recommended that the LEDs be stored in a sealed container with appropriate desiccant, or in a desiccators with nitrogen ambient.

LEDs stored out of their original packaging for more than 168hrs should be baked at about 60 °C for at least 48 hours before solder assembly.

#### 7.3 Cleaning

Use alcohol-based cleaning solvents such as isopropyl alcohol to clean the LED if necessary.

#### 7.4 Soldering

Recommended soldering conditions:

Reflow soldering		Soldering iron	
Pre-heat	150~200°C	Temperature	300°C Max.
Pre-heat time	120 sec. Max.	Soldering time	3 sec. Max.
Peak temperature	260°C Max.		(one time only)
Soldering time	10 sec. Max.(Max. two times)		

#### Notes:

Because different board designs use different number and types of devices, solder pastes, reflow ovens, and circuit boards, no single temperature profile works for all possible combinations.

However, you can successfully mount your packages to the PCB by following the proper guidelines and PCB-specific characterization.

LITE-ON Runs both component-level verification using in-house **KYRAMX98** reflow chambers and board-level assembly. The results of this testing are verified through post-reflow reliability testing. Profiles used at LITE-ON are based on JEDEC standards to ensure that all packages can be successfully and reliably surface mounted.

Figure on page3 shows a sample temperature profile compliant to JEDEC standards. You can use this example as a generic target to set up your reflow process. You should adhere to the JEDEC profile limits as well as specifications and recommendations from the solder paste manufacturer to avoid damaging the device and create a reliable solder joint.

## SMD LED LTST-006GEBW-P2

### 7.5 Drive Method

A LED is a current-operated device. In order to ensure intensity uniformity on multiple LEDs connected in parallel in an application, it is recommended that a current limiting resistor be incorporated in the drive circuit, in series with each LED as shown in Circuit A below.

**Circuit model A**



**Circuit model B**



(A) Recommended circuit.

(B) The brightness of each LED might appear different due to the differences in the I-V characteristics of those LEDs.

### 7.6 ESD (Electrostatic Discharge)

Static Electricity or power surge will damage the LED.

Suggestions to prevent ESD damage:

- Use of a conductive wrist band or anti-electrostatic glove when handling these LEDs.
- All devices, equipment, and machinery must be properly grounded.
- Work tables, storage racks, etc. should be properly grounded.
- Use ion blower to neutralize the static charge which might have built up on surface of the LED's plastic lens as a result of friction between LEDs during storage and handling.

ESD-damaged LEDs will exhibit abnormal characteristics such as high reverse leakage current, low forward voltage, or "no lightup" at low currents.

To verify for ESD damage, check for "lightup" and  $V_f$  of the suspect LEDs at low currents.

The  $V_f$  of "good" LEDs should be  $>2.0V@0.1mA$  for InGaN product and  $>1.4V@0.1mA$  for AlInGaP product.

**SMD LED  
LTST-006GEBW-P2**

**8. Reliability Test**

No.	Test item	Test condition	Reference standard
1	Resistance to soldering heat	Tsld = 260°C, 10sec. 3 times	JEITA ED-4701 300 301
2	Solderability	Tsld=245± 5°C (Lead Free Solder, Coverage ≥ 95% of the dipped surface)	JEITA ED-4701 300 303
3	Thermal Shock	85 ± 5°C ~ -30°C ± 5°C 30min                      30min 100cycles	JEITA ED-4701 300 307
4	Temperature Cycle	-40°C ~ 25°C ~ 100°C ~ 25°C 30min 5min 30min 5min 100cycles	JEITA ED-4701 100 105
5	High Temperature Storage	100°C    1000hrs	JEITA ED- 4701 200 201
6	Low Temperature Storage	-40°C    1000hrs	JEITA ED-4 701 200 202
7	Temperature Humidity Storage	60°C/90%RH 300hrs	JEITA ED-4701 100 103
8	Room temp life test	25°C, IF: Typical current , 100 0hrs	--

**9. Others**

The appearance and specifications of the product may be modified for improvement without prior notice.

**SMD LED  
LTST-006GEBW-P2**

## 10. Suggested Checking List

### Training and Certification

1. Everyone working in a static-safe area is ESD-certified?
2. Training records kept and re-certification dates monitored?

### Static-Safe Workstation & Work Areas

1. Static-safe workstation or work-areas have ESD signs?
2. All surfaces and objects at all static-safe workstation and within 1 ft measure less than 100V?
3. All ionizer activated, positioned towards the units?
4. Each work surface mats grounding is good?

### Personnel Grounding

1. Every person (including visitors) handling ESD sensitive (ESDS) items wears wrist strap, heel strap or conductive shoes with conductive flooring?
2. If conductive footwear used, conductive flooring also present where operator stand or walk?
3. Garments, hairs or anything closer than 1 ft to ESD items measure less than 100V\*?
4. Every wrist strap or heel strap/conductive shoes checked daily and result recorded for all DLs?
5. All wrist strap or heel strap checkers calibration up to date?

Note: \*50V for InGaN LED.

### Device Handling

1. Every ESDS items identified by EIA-471 labels on item or packaging?
2. All ESDS items completely inside properly closed static-shielding containers when not at static-safe workstation?
3. No static charge generators (e.g. plastics) inside shielding containers with ESDS items?
4. All flexible conductive and dissipative package materials inspected before reuse or recycles?

### Others

1. Audit result reported to entity ESD control coordinator?
2. Corrective action from previous audits completed?
3. Are audit records complete and on file?