

# E2E (E2E-X□D□-U/E2E-X□D□S/E2E-X□Y□/E2E-X□T□)

DC 2-Wire (PUR Cable/Self-diagnosis Output), AC 2-Wire and AC/DC 2-Wire

CSM\_E2E\_DS\_E\_13\_2

## Models with DC 2-Wire (Self-diagnosis Output) and AC 2-Wire added to the lineup

- Detecting ferrous metals.
- Models with different frequencies are also available to prevent mutual interference.
- Superior environment resistance with standard cable made of oil-resistant PVC and sensing surface made of material that resists cutting oil.
- Useful to help prevent disconnection. Cable protector provided as a standard feature.

CE UL CCC (Standards do not apply to all models.)



 Be sure to read *Safety Precautions* on page 16.

For the most recent information on models that have been certified for safety standards, refer to your OMRON website.

## Features

### DC 2-Wire

#### Pre-wired models with oil-resistant reinforced PUR Cable added to the lineup



Oil Resistance (Insulation service life): twice or three times that of oil-resistant vinyl chloride

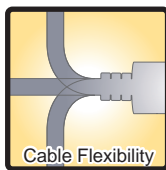

Cable Flexibility: approximately twice that of vinyl chloride cables

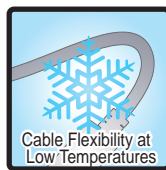

More Flexibility at -40°C

## E2E Model Number Legend

E2E- 1 2 3 4 5 6 7 - 8 9 - 10 - 11 12





| No. | Classification                         | Code     | Meaning  | Remarks   |
|-----|--|----------|--|---|
| 1   | Appearance                             | X        | Cylindrical (threaded)   |   |
| 2   | Sensing distance                       | Number   | Sensing distance (Unit: mm)  | Example:<br>1R5: 1.5 mm                                 |
|     |  | R        | Indication of decimal point  |   |
| 3   | Shielding                              | Blank    | Shielded Model   |   |
|     |  | M        | Unshielded Model   |   |
| 4   | Power supply and output specifications | D        | DC 2-wire polarity/no polarity   | Whether D models have polarity is defined by number 10. |
|     |  | T        | AC/DC 2-wire   |   |
|     |  | Y        | AC 2-wire  |   |
| 5   | Form of output switching element       | 1        | Normally open (NO)   |   |
|     |  | 2        | Normally closed (NC)   |   |
| 6   | Oscillation frequency type             | Blank    | Standard frequency   | Used to prevent mutual interference.                    |
|     |  | 5        | Different frequency  |   |
| 7   | Self-diagnosis                         | Blank    | No   |   |
|     |  | S        | Yes  |   |
| 8   | Connection method                      | Blank    | Pre-wired  |   |
|     |  | M1       | M12-size metal connector   |   |
| 9   | Connector specifications               | Blank    | Connector Model<br>AC 2-wire,<br>DC 2-wire with self-diagnosis output,<br>DC 2-wire with old pin arrangement |   |
|     |  | J        | Pre-wired Connector Model<br>AC 2-wire,<br>DC 2-wire with old pin arrangement                                |   |
|     |  | GJ       | Pre-wired Connector Model<br>DC 2-wire with IEC pin arrangement  |   |
|     |  | TJ       | Pre-wired Smartclick Connector Model<br>DC 2-wire  |   |
|     |  | TGJ      | Pre-wired Smartclick Connector Model<br>DC 2-wire with IEC pin arrangement                                   |   |
| 10  | DC 2-wire polarity                     | Blank    | Polarity   |   |
|     |  | T        | No polarity  |   |
| 11  | Cable specifications                   | Blank    | Standard PVC cable (oil resistant)   |   |
|     |  | R        | Flexible PVC cable (oil resistant)   |   |
|     |  | U        | Polyurethane cable (oil resistant and reinforced)  |   |
| 12  | Cable length                           | Letter M | Cable length (Unit: m)<br>(Applicable to Pre-wired Models and Pre-wired Connector Models.)                   | Example:<br>2M<br>0.3M                                  |

Note: The purpose of this model number legend is to provide understanding of the meaning of specifications from the model number. Models are not available for all combinations of code numbers.

## Ordering Information

DC 2-Wire (No Self-diagnosis Output, PUR Cable models) [Refer to *Dimensions* on page 18.]

Shielded Models 

| Appearance | Sensing distance  |       |  | Connection method                                 | Cable specifications | Polarity | Operation mode | Pin arrangement | Model                  |
|------------|---|-------|--|---|----------------------|----------|----------------|-----------------|------------------------|
| M8         |  | 2 mm  |  | Pre-wired Models (2 m)                            | PUR                  | Yes      | NO             | ---             | E2E-X2D1-U 2M          |
|            |   |       |  |   |                      |          | NC             |                 | E2E-X2D2-U 2M          |
|            |   |       |  | M12 Pre-wired Smartclick Connector Models (0.3 m) | PUR                  |          | NO             | 1: +V, 4: 0 V   | E2E-X2D1-M1TGJ-U 0.3M  |
|            |   |       |  |   |                      |          | NC             | 1: +V, 2: 0 V   | E2E-X2D2-M1TGJ-U 0.3M  |
| M12        |  | 3 mm  |  | Pre-wired Models (2 m)                            | PUR                  | Yes      | NO             | ---             | E2E-X3D1-U 2M          |
|            |   |       |  |   |                      |          | NC             |                 | E2E-X3D2-U 2M          |
|            |   |       |  | M12 Pre-wired Smartclick Connector Models (0.3 m) | PUR                  |          | NO             | 1: +V, 4: 0 V   | E2E-X3D1-M1TGJ-U 0.3M  |
|            |   |       |  |   |                      |          | NC             | 1: +V, 2: 0 V   | E2E-X3D2-M1TGJ-U 0.3M  |
| M18        |  | 7 mm  |  | Pre-wired Models (2 m)                            | PUR                  | Yes      | NO             | ---             | E2E-X7D1-U 2M          |
|            |   |       |  |   |                      |          | NC             |                 | E2E-X7D2-U 2M          |
|            |   |       |  | M12 Pre-wired Smartclick Connector Models (0.3 m) | PUR                  |          | NO             | 1: +V, 4: 0 V   | E2E-X7D1-M1TGJ-U 0.3M  |
|            |   |       |  |   |                      |          | NC             | 1: +V, 2: 0 V   | E2E-X7D2-M1TGJ-U 0.3M  |
| M30        |  | 10 mm |  | Pre-wired Models (2 m)                            | PUR                  | Yes      | NO             | ---             | E2E-X10D1-U 2M         |
|            |   |       |  |   |                      |          | NC             |                 | E2E-X10D2-U 2M         |
|            |   |       |  | M12 Pre-wired Smartclick Connector Models (0.3 m) | PUR                  |          | NO             | 1: +V, 4: 0 V   | E2E-X10D1-M1TGJ-U 0.3M |
|            |   |       |  |   |                      |          | NC             | 1: +V, 2: 0 V   | E2E-X10D2-M1TGJ-U 0.3M |

**DC 2-Wire (Self-diagnosis Output models) [Refer to Dimensions on page 19.]**

**Shielded Models** 

| Appearance | Sensing distance | Connection method      | Cable specifications | Polarity | Operation mode | Pin arrangement   | Model            |
|------------|------------------|------------------------|----------------------|----------|----------------|---|------------------|
| M12        | 3 mm             | Pre-wired Models (2 m) | PVC (oil-resistant)  | Yes      | NO             | ---   | E2E-X3D1S 2M *1  |
|            |                  | M12 Connector Models   | ---                  |          |                | 2: +V and diagnostic output<br>3: 0 V<br>4: +V and control output | E2E-X3D1S-M1     |
| M18        | 7 mm             | Pre-wired Models (2 m) | PVC (oil-resistant)  |          |                | ---   | E2E-X7D1S 2M *1  |
|            |                  | M12 Connector Models   | ---                  |          |                | 2: +V and diagnostic output<br>3: 0 V<br>4: +V and control output | E2E-X7D1S-M1     |
| M30        | 10 mm            | Pre-wired Models (2 m) | PVC (oil-resistant)  |          |                | ---   | E2E-X10D1S 2M *1 |
|            |                  | M12 Connector Models   | ---                  |          |                | 2: +V and diagnostic output<br>3: 0 V<br>4: +V and control output | E2E-X10D1S-M1    |

\*1. Models with different frequencies are also available. The model number is E2E-X □D15S (example: E2E-X3D15S 2M).

**Unshielded Models** 

| Appearance | Sensing distance | Connection method      | Cable specifications | Polarity | Operation mode | Pin arrangement   | Model             |
|------------|------------------|------------------------|----------------------|----------|----------------|---|-------------------|
| M12        | 8 mm             | Pre-wired Models (2 m) | PVC (oil-resistant)  | Yes      | NO             | ---   | E2E-X8MD1S 2M *1  |
|            |                  | M12 Connector Models   | ---                  |          |                | 2: +V and diagnostic output<br>3: 0 V<br>4: +V and control output | E2E-X8MD1S-M1     |
| M18        | 14 mm            | Pre-wired Models (2 m) | PVC (oil-resistant)  |          |                | ---   | E2E-X14MD1S 2M *1 |
|            |                  | M12 Connector Models   | ---                  |          |                | 2: +V and diagnostic output<br>3: 0 V<br>4: +V and control output | E2E-X14MD1S-M1    |
| M30        | 20 mm            | Pre-wired Models (2 m) | PVC (oil-resistant)  |          |                | ---   | E2E-X20MD1S 2M *1 |
|            |                  | M12 Connector Models   | ---                  |          |                | 2: +V and diagnostic output<br>3: 0 V<br>4: +V and control output | E2E-X20MD1S-M1    |

\*1. Models with different frequencies are also available. The model number is E2E-X □MD15S (example: E2E-X8MD15S 2M).

**Connector Pin Assignments of DC 2-Wire Models**

- The connector pin assignments of each New E2E DC 2-Wire Model conform to IEC 947-5-2 Table III. (Only DC 2-Wire Models have been changed in comparison to the previous models.)
- The following models with conventional connector pin assignments are available as well. (Only NO Models can be used.)  
The cable at the right should also be used if the XW3D-P□55-G11/XW3B-P□55-G11 Connector Junction Box is already being used.

| Cable length | Model                |
|--------------|----------------------|
| 500 mm       | <b>XS2W-D421-BY1</b> |

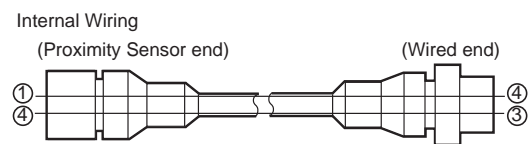

## AC 2-Wire [Refer to Dimensions on page 21.]

Shielded Models 

| Appearance | Sensing distance | Connection method      | Cable specifications | Operation mode | Pin arrangement  | Model            |
|------------|------------------|------------------------|----------------------|----------------|------------------|------------------|
| M8         | 1.5 mm           | Pre-wired Models (2 m) | PVC (oil-resistant)  | NO             | ---              | E2E-X1R5Y1 2M *2 |
|            |                  |                        |                      | NC             |                  | E2E-X1R5Y2 2M *2 |
| M12        | 2 mm             | Pre-wired Models (2 m) | PVC (oil-resistant)  | NO             | ---              | E2E-X2Y1 2M *1   |
|            |                  |                        |                      | NC             |                  | E2E-X2Y2 2M      |
|            |                  | M12 Connector Models   | ---                  | NO             | (3, 4): (AC, AC) | E2E-X2Y1-M1      |
|            |                  |                        |                      | NC             | (1, 2): (AC, AC) | E2E-X2Y2-M1      |
| M18        | 5 mm             | Pre-wired Models (2 m) | PVC (oil-resistant)  | NO             | ---              | E2E-X5Y1 2M *1   |
|            |                  |                        |                      | NC             |                  | E2E-X5Y2 2M      |
|            |                  | M12 Connector Models   | ---                  | NO             | (3, 4): (AC, AC) | E2E-X5Y1-M1      |
|            |                  |                        |                      | NC             | (1, 2): (AC, AC) | E2E-X5Y2-M1      |
| M30        | 10 mm            | Pre-wired Models (2 m) | PVC (oil-resistant)  | NO             | ---              | E2E-X10Y1 2M *1  |
|            |                  |                        |                      | NC             |                  | E2E-X10Y2 2M     |
|            |                  | M12 Connector Models   | ---                  | NO             | (3, 4): (AC, AC) | E2E-X10Y1-M1     |
|            |                  |                        |                      | NC             | (1, 2): (AC, AC) | E2E-X10Y2-M1     |

\*1. Models with different frequencies are also available. The model number is E2E-X □Y□5 (example: E2E-X5Y15 2M).

\*2. Discontinued at the end of March 2022.

Unshielded Models 

| Appearance | Sensing distance | Connection method      | Cable specifications | Operation mode | Pin arrangement  | Model            |
|------------|------------------|------------------------|----------------------|----------------|------------------|------------------|
| M8         | 2 mm             | Pre-wired Models (2 m) | PVC (oil-resistant)  | NO             | ---              | E2E-X2MY1 2M *2  |
|            |                  |                        |                      | NC             |                  | E2E-X2MY2 2M *2  |
| M12        | 5 mm             | Pre-wired Models (2 m) | PVC (oil-resistant)  | NO             | ---              | E2E-X5MY1 2M *1  |
|            |                  |                        |                      | NC             |                  | E2E-X5MY2 2M     |
|            |                  | M12 Connector Models   | ---                  | NO             | (3, 4): (AC, AC) | E2E-X5MY1 2M     |
|            |                  |                        |                      | NC             | (1, 2): (AC, AC) | E2E-X5MY2-M1     |
| M18        | 10 mm            | Pre-wired Models (2 m) | PVC (oil-resistant)  | NO             | ---              | E2E-X10MY1 2M *1 |
|            |                  |                        |                      | NC             |                  | E2E-X10MY2 2M    |
|            |                  | M12 Connector Models   | ---                  | NO             | (3, 4): (AC, AC) | E2E-X10MY1-M1    |
|            |                  |                        |                      | NC             | (1, 2): (AC, AC) | E2E-X10MY2-M1    |
| M30        | 18 mm            | Pre-wired Models (2 m) | PVC (oil-resistant)  | NO             | ---              | E2E-X18MY1 2M *1 |
|            |                  |                        |                      | NC             |                  | E2E-X18MY2 2M    |
|            |                  | M12 Connector Models   | ---                  | NO             | (3, 4): (AC, AC) | E2E-X18MY1-M1    |
|            |                  |                        |                      | NC             | (1, 2): (AC, AC) | E2E-X18MY2-M1    |

\*1. Models with different frequencies are also available. The model number is E2E-X □MY□5 (example: E2E-X5MY15 2M).

\*2. Discontinued at the end of March 2022.

## AC/DC 2-Wire [Refer to Dimensions on page 23.]

Shielded Models 

| Appearance | Sensing distance | Connection method      | Cable specifications | Operation mode | Pin arrangement | Applicable connector code | Model        |
|------------|------------------|------------------------|----------------------|----------------|-----------------|---------------------------|--------------|
| M12        | 3 mm             | Pre-wired Models (2 m) | PVC (oil-resistant)  | NO             | ---             | ---                       | E2E-X3T1 2M  |
| M18        | 7 mm             | Pre-wired Models (2 m) | PVC (oil-resistant)  |                | ---             | ---                       | E2E-X7T1 2M  |
| M30        | 10 mm            | Pre-wired Models (2 m) | PVC (oil-resistant)  |                | ---             | ---                       | E2E-X10T1 2M |



Note: There are no unshielded models.

## Accessories (Sold Separately)



### Sensor I/O Connectors

A Sensor I/O Connector is not provided with the Sensor. It must be ordered separately as required.

#### Round Water-resistant Connectors XS5 Series

| Appearance  | Cable Specification              | Type                                  | Cable diameter (mm) | Cable Connection Direction | Cable length (m) | Sensor I/O Connector model number | Applicable Proximity Sensor model number |
|---|----------------------------------|---------------------------------------|---------------------|----------------------------|------------------|-----------------------------------|--|
| M12 Smartclick Connector<br><br>Straight type<br><br><br>Right-angle type<br> | Oil-resistant polyurethane cable | Sockets on One Cable End              | 6 dia.              | Straight                   | 2 m              | XS5F-D421-D80-P                   | E2E-X□D□-M1TGJ-U                         |
|   |                                  |                                       |                     |                            | 5 m              | XS5F-D421-G80-P                   |  |
|   |                                  |                                       |                     | Right-angle                | 2 m              | XS5F-D422-D80-P                   |  |
|   |                                  |                                       |                     |                            | 5 m              | XS5F-D422-G80-P                   |  |
|   |                                  | Straight (Socket)/<br>Straight (Plug) |                     | 2 m                        | XS5W-D421-D81-P  |                                   |  |
|   |                                  |                                       |                     | 5 m                        | XS5W-D421-G81-P  |                                   |  |

#### Round Water-resistant Connectors XS2 Series

| Appearance   | Cable Specification             | Type                                  | Cable diameter (mm) | Cable Connection Direction | Cable length (m) | Sensor I/O Connector model number | Applicable Proximity Sensor model number |
|--|---------------------------------|---------------------------------------|---------------------|----------------------------|------------------|-----------------------------------|--|
| M12 Screw Connector<br><br>Straight type<br><br><br>Right-angle type<br> | Fire-retardant, PVC Robot Cable | Sockets on One Cable End              | 6 dia.              | Straight                   | 2 m              | XS2F-D421-D80-F                   | E2E-X□D□S-M1                             |
|  |                                 |                                       |                     |                            | 5 m              | XS2F-D421-G80-F                   |  |
|  |                                 |                                       |                     | Right-angle                | 2 m              | XS2F-D422-D80-F                   |  |
|  |                                 | 5 m                                   |                     |                            | XS2F-D422-G80-F  |                                   |  |
|  |                                 | Straight (Socket)/<br>Straight (Plug) |                     | 2 m                        | XS2W-D421-D81-F  |                                   |  |
|  |                                 |                                       |                     | 5 m                        | XS2W-D421-G81-F  |                                   |  |
|  | Fire-retardant, PVC Robot Cable | Sockets on One Cable End              | 6 dia.              | Straight                   | 2 m              | XS2F-A421-DB0-F                   | E2E-X□Y1-M1                              |
|  |                                 |                                       |                     |                            | 5 m              | XS2F-A421-GB0-F                   |  |
|  |                                 |                                       |                     | Right-angle                | 2 m              | XS2F-A422-DB0-F                   |  |
|  |                                 |                                       |                     |                            | 5 m              | XS2F-A422-GB0-F                   |  |
| Fire-retardant, PVC Robot Cable  | Sockets on One Cable End        | 6 dia.                                | Straight            | 2 m                        | XS2F-A421-D90-F  | E2E-X□Y2-M1                       |  |
|  |                                 |                                       |                     | 5 m                        | XS2F-A421-G90-F  |                                   |  |

Note: For details, refer to *Sensor I/O Connectors/Sensor Controllers* on your OMRON website.

## Ratings and Specifications

### DC 2-Wire (E2E-X□D□)

| Item  | Size<br>Shielded<br>Model  | M8  |                                     | M12   |                         | M18                  |               | M30                     |            |
|---|----------------------------|---|-------------------------------------|---|-------------------------|----------------------|---------------|-------------------------|------------|
|   |                            | Shielded  | Shielded                            | Shielded  | Unshielded              | Shielded             | Unshielded    | Shielded                | Unshielded |
|   |                            | E2E-X2D□  | E2E-X3D□                            | E2E-X8MD□   | E2E-X7D□                | E2E-X14MD□           | E2E-X10D□     | E2E-X20MD□              |            |
| Sensing distance                                  |                            | 2 mm ±10%   | 3 mm ±10%                           | 8 mm ±10%   | 7 mm ±10%               | 14 mm ±10%           | 10 mm ±10%    | 20 mm ±10%              |            |
| Set distance *1                                   |                            | 0 to 1.6 mm   | 0 to 2.4 mm                         | 0 to 6.4 mm   | 0 to 5.6 mm             | 0 to 11.2 mm         | 0 to 8 mm     | 0 to 16 mm              |            |
| Differential travel                               |                            | 15% max. of sensing distance  | 10% max. of sensing distance        |   |                         |                      |               |                         |            |
| Detectable object                                 |                            | Ferrous metal (The sensing distance decreases with non-ferrous metal. Refer to <i>Engineering Data</i> on pages 10 and 11.    |                                     |   |                         |                      |               |                         |            |
| Standard sensing object                           |                            | Iron,<br>8 × 8 × 1 mm   | Iron,<br>12 × 12 × 1 mm             | Iron,<br>30 × 30 × 1 mm   | Iron,<br>18 × 18 × 1 mm | Iron, 30 × 30 × 1 mm |               | Iron,<br>54 × 54 × 1 mm |            |
| Response frequency *2                             |                            | 1.5 kHz   | 1 kHz                               | 0.8 kHz   | 0.5 kHz                 | 0.4 kHz              |               | 0.1 kHz                 |            |
| Power supply voltage<br>(operating voltage range) |                            | 12 to 24 VDC, ripple (p-p): 10% max. (10 to 30 VDC)   |                                     |   |                         |                      |               |                         |            |
| Leakage current                                   |                            | 0.8 mA max.   |                                     |   |                         |                      |               |                         |            |
| Control output                                    | Load current               | 3 to 100 mA, Diagnostic output: 50 mA for -D1(5)S Models  |                                     |   |                         |                      |               |                         |            |
|   | Residual voltage           | 3 V max. (Load current: 100 mA, Cable length: 2 m)  |                                     |   |                         |                      |               |                         |            |
| Indicators  |                            | D1 Models: Operation indicator (red) and setting indicator (green)<br>D2 Models: Operation indicator (red)                    |                                     |   |                         |                      |               |                         |            |
| Operation mode (with sensing object approaching)  |                            | D1 Models: NO      Refer to the timing charts under <i>I/O Circuit Diagrams</i> on page 13 for details.<br>D2 Models: NC      |                                     |   |                         |                      |               |                         |            |
| Diagnostic output delay                           |                            | 0.3 to 1 s  |                                     |   |                         |                      |               |                         |            |
| Protection circuits                               |                            | Surge suppressor, Load short-circuit protection (for control and diagnostic output)   |                                     |   |                         |                      |               |                         |            |
| Ambient temperature range                         |                            | Operating: -25 to 70°C, Storage: -40 to 85°C (with no icing or condensation)  |                                     |   |                         |                      |               |                         |            |
| Ambient humidity range                            |                            | Operating/storage: 35% to 95% (with no condensation)  |                                     |   |                         |                      |               |                         |            |
| Temperature influence                             |                            | ±15% max. of sensing distance at 23°C in the temperature range of -25 to 70°C   |                                     | ±10% max. of sensing distance at 23°C in the temperature range of -25 to 70°C |                         |                      |               |                         |            |
| Voltage influence                                 |                            | ±1% max. of sensing distance at rated voltage in the rated voltage ±15% range   |                                     |   |                         |                      |               |                         |            |
| Insulation resistance                             |                            | 50 MΩ min. (at 500 VDC) between current-carrying parts and case   |                                     |   |                         |                      |               |                         |            |
| Dielectric strength                               |                            | 1000 VAC, 50/60 Hz for 1 minute between current carry parts and case  |                                     |   |                         |                      |               |                         |            |
| Vibration resistance                              |                            | Destruction: 10 to 55 Hz, 1.5-mm double amplitude for 2 hours each in X, Y, and Z directions                                  |                                     |   |                         |                      |               |                         |            |
| Shock resistance                                  |                            | Destruction: 500 m/s <sup>2</sup> 10 times each in X, Y, and Z directions   |                                     | Destruction: 1,000 m/s <sup>2</sup> 10 times each in X, Y, and Z directions   |                         |                      |               |                         |            |
| Degree of protection                              |                            | Pre-wired Models: IEC 60529 IP67, in-house standards: oil-resistant<br>Connector Models: IEC 60529 IP67                       |                                     |   |                         |                      |               |                         |            |
| Connection method                                 |                            | Pre-wired Models (Standard cable length: 2 m), Connector Models, or Pre-wired Connector Models (Standard cable length: 0.3 m) |                                     |   |                         |                      |               |                         |            |
| Weight<br>(packed state)                          | Pre-wired Models           | Approx. 60 g  | Approx. 70 g                        |   | Approx. 130 g           |                      | Approx. 175 g |                         |            |
|   | Pre-wired Connector Models | ---   | Approx. 40 g (Shielded Models only) |   | ---                     |                      | ---           |                         |            |
|   | Connector Models           | Approx. 15 g  | Approx. 25 g                        |   | Approx. 40 g            |                      | Approx. 90 g  |                         |            |
| Materials   | Case                       | Stainless steel (SUS303)  |                                     | Nickel-plated brass   |                         |                      |               |                         |            |
|   | Sensing surface            | PBT   |                                     |   |                         |                      |               |                         |            |
|   | Clamping nuts              | Nickel-plated brass   |                                     |   |                         |                      |               |                         |            |
|   | Toothed washer             | Zinc-plated iron  |                                     |   |                         |                      |               |                         |            |
| Accessories                                       |                            | Instruction manual  |                                     |   |                         |                      |               |                         |            |

\*1. Use the E2E within the range in which the setting indicator (green LED) is ON (except D2 Models).

\*2. The response frequency is an average value.

Measurement conditions are as follows: standard sensing object, a distance of twice the standard sensing object, and a set distance of half the sensing distance.

## AC 2-Wire (E2E-X□Y□)

| Item   | Size   |  | M8                   |            | M12  |                      | M18        |                      | M30        |                      |  |
|--|--|--|----------------------|------------|--|----------------------|------------|----------------------|------------|----------------------|--|
|  | Shielded Model   | Unshielded Model                             | Shielded             | Unshielded | Shielded   | Unshielded           | Shielded   | Unshielded           | Shielded   | Unshielded           |  |
|  |  |  | E2E-X1R5Y□           | E2E-X2MY□  | E2E-X2Y□   | E2E-X5MY□            | E2E-X5Y□   | E2E-X10MY□           | E2E-X10Y□  | E2E-X18MY□           |  |
| <b>Sensing distance</b>  | 1.5 mm ±10%  |  | 2 mm ±10%            |            | 5 mm ±10%  |                      | 10 mm ±10% |                      | 18 mm ±10% |                      |  |
| <b>Set distance</b>  | 0 to 1.2 mm  |  | 0 to 1.6 mm          |            | 0 to 4 mm  |                      | 0 to 8 mm  |                      | 0 to 14 mm |                      |  |
| <b>Differential travel</b>   | 10% max. of sensing distance   |  |                      |            |  |                      |            |                      |            |                      |  |
| <b>Detectable object</b>   | Ferrous metal (The sensing distance decreases with non-ferrous metal. Refer to <i>Engineering Data</i> on page 11.)    |  |                      |            |  |                      |            |                      |            |                      |  |
| <b>Standard sensing object</b>                                     | Iron, 8 × 8 × 1 mm   |  | Iron, 12 × 12 × 1 mm |            |  | Iron, 15 × 15 × 1 mm |            | Iron, 18 × 18 × 1 mm |            | Iron, 30 × 30 × 1 mm |  |
| <b>Response frequency</b>  | 25 Hz  |  |                      |            |  |                      |            |                      |            |                      |  |
| <b>Power supply voltage (operating voltage range)<sup>*1</sup></b> | 24 to 240 VAC (20 to 264 VAC), 50/60 Hz  |  |                      |            |  |                      |            |                      |            |                      |  |
| <b>Leakage current</b>   | 1.7 mA max.  |  |                      |            |  |                      |            |                      |            |                      |  |
| <b>Control output</b>  | <b>Load current<sup>*2</sup></b>   | 5 to 100 mA                                  |                      |            | 5 to 200 mA  |                      |            | 5 to 300 mA          |            |                      |  |
|  | <b>Residual voltage</b>  | Refer to <i>Engineering Data</i> on page 12. |                      |            |  |                      |            |                      |            |                      |  |
| <b>Indicators</b>  | Operation indicator (red)  |  |                      |            |  |                      |            |                      |            |                      |  |
| <b>Operation mode (with sensing object approaching)</b>            | Y1 Models: NO    Y2 Models: NC    Refer to the timing charts under <i>I/O Circuit Diagrams</i> on page 14 for details. |  |                      |            |  |                      |            |                      |            |                      |  |
| <b>Protection circuits</b>   | Surge suppressor   |  |                      |            |  |                      |            |                      |            |                      |  |
| <b>Ambient temperature range<sup>*1*2</sup></b>                    | Operating/Storage: -25 to 70°C (with no icing or condensation)   |  |                      |            | Operating/Storage: -40 to 85°C (with no icing or condensation)   |                      |            |                      |            |                      |  |
| <b>Ambient humidity range</b>                                      | Operating/storage: 35% to 95% (with no condensation)   |  |                      |            |  |                      |            |                      |            |                      |  |
| <b>Temperature influence</b>                                       | ±10% max. of sensing distance at 23°C in the temperature range of -25 to 70°C  |  |                      |            | ±15% max. of sensing distance at 23°C in the temperature range of -40 to 85°C, ±10% max. of sensing distance at 23°C in the temperature range of -25 to 70°C |                      |            |                      |            |                      |  |
| <b>Voltage influence</b>   | ±1% max. of sensing distance at rated voltage in the rated voltage ±15% range  |  |                      |            |  |                      |            |                      |            |                      |  |
| <b>Insulation resistance</b>                                       | 50 MΩ min. (at 500 VDC) between current-carrying parts and case  |  |                      |            |  |                      |            |                      |            |                      |  |
| <b>Dielectric strength</b>   | 4,000 VAC (M8 Models: 2,000 VAC), 50/60 Hz for 1 min between current-carrying parts and case                           |  |                      |            |  |                      |            |                      |            |                      |  |
| <b>Vibration resistance</b>  | Destruction: 10 to 55 Hz, 1.5-mm double amplitude for 2 hours each in X, Y, and Z directions                           |  |                      |            |  |                      |            |                      |            |                      |  |
| <b>Shock resistance</b>  | Destruction: 500 m/s <sup>2</sup> 10 times each in X, Y, and Z directions  |  |                      |            | Destruction: 1,000 m/s <sup>2</sup> 10 times each in X, Y, and Z directions  |                      |            |                      |            |                      |  |
| <b>Degree of protection</b>  | Pre-wired Models: IEC 60529 IP67, in-house standards: oil-resistant<br>Connector Models: IEC 60529 IP67                |  |                      |            |  |                      |            |                      |            |                      |  |
| <b>Connection method</b>   | Pre-wired Models (Standard cable length: 2 m) and Connector Models   |  |                      |            |  |                      |            |                      |            |                      |  |
| <b>Weight (packed state)</b>                                       | <b>Pre-wired Models Model</b>  | Approx. 60 g                                 |                      |            | Approx. 70 g   |                      |            | Approx. 130 g        |            | Approx. 175 g        |  |
|  | <b>Connector Models</b>  | Approx. 15 g                                 |                      |            | Approx. 25 g   |                      |            | Approx. 40 g         |            | Approx. 90 g         |  |
| <b>Materials</b>   | <b>Case</b>  | Stainless steel (SUS303)                     |                      |            | Nickel-plated brass  |                      |            |                      |            |                      |  |
|  | <b>Sensing surface</b>   | PBT  |                      |            |  |                      |            |                      |            |                      |  |
|  | <b>Clamping nuts</b>   | Nickel-plated brass                          |                      |            |  |                      |            |                      |            |                      |  |
|  | <b>Toothed washer</b>  | Zinc-plated iron                             |                      |            |  |                      |            |                      |            |                      |  |
| <b>Accessories</b>   | Instruction manual   |  |                      |            |  |                      |            |                      |            |                      |  |

\*1. When supplying 24 VAC to any of the above models, make sure that the operating ambient temperature range is at least -25°C.

\*2. When using an M18 or M30 Connector Model at an ambient temperature between 70 and 85°C, make sure that the Sensor has a control output (load current) of 5 to 200 mA max.



## AC/DC 2-Wire (E2E-X□T1)

| Item  | Size<br>Shielded<br>Model | M12   | M18                  | M30                  |
|---|---------------------------|---|----------------------|----------------------|
|   |                           | Shielded  |                      |                      |
|   |                           | E2E-X3T1  | E2E-X7T1             | E2E-X10T1            |
| Sensing distance                                  |                           | 3 mm ±10%   | 7 mm ±10%            | 10 mm ±10%           |
| Set distance                                      |                           | 0 to 2.4 mm   | 0 to 5.6 mm          | 0 to 8 mm            |
| Differential travel                               |                           | 10% max. of sensing distance  |                      |                      |
| Detectable object                                 |                           | Ferrous metal (The sensing distance decreases with non-ferrous metal. Refer to <i>Engineering Data</i> on page 10.) |                      |                      |
| Standard sensing object                           |                           | Iron, 12 × 12 × 1 mm  | Iron, 18 × 18 × 1 mm | Iron, 30 × 30 × 1 mm |
| Response frequency *1                             | DC                        | 1 kHz   | 0.5 kHz              | 0.4 kHz              |
|   | AC                        | 25 Hz   |                      |                      |
| Power supply voltage (operating voltage range) *2 |                           | 24 to 240 VDC (20 to 264 VDC)<br>48 to 240 VAC (40 to 264 VAC)  |                      |                      |
| Leakage current                                   |                           | DC: 1 mA max.<br>AC: 2 mA max.  |                      |                      |
| Control output                                    | Load current              | 5 to 100 mA   |                      |                      |
|   | Residual voltage          | DC: 6 V max. (Load current: 100 mA, Cable length: 2 m)<br>AC: 10 V max. (Load current: 5 mA, Cable length: 2 m)     |                      |                      |
| Indicators  |                           | Operation indicator (red), Setting indicator (green)  |                      |                      |
| Operation mode (with sensing object approaching)  |                           | NO (Refer to the timing charts under <i>I/O Circuit Diagrams</i> on page 14 for details.)                           |                      |                      |
| Protection circuits                               |                           | Load short-circuit protection (20 to 40 VDC only), Surge suppressor   |                      |                      |
| Ambient temperature range                         |                           | Operating: -25 to 70°C, Storage: -40 to 85°C (with no icing or condensation)  |                      |                      |
| Ambient humidity range                            |                           | Operating/Storage: 35% to 95% (with no condensation)  |                      |                      |
| Temperature influence                             |                           | ±10% max. of sensing distance at 23°C in the temperature range of -25 to 70°C                                       |                      |                      |
| Voltage influence                                 |                           | ±1% max. of sensing distance at rated voltage in the rated voltage ±15% range                                       |                      |                      |
| Insulation resistance                             |                           | 50 MΩ min. (at 500 VDC) between current-carrying parts and case   |                      |                      |
| Dielectric strength                               |                           | 4,000 VAC, 50/60 Hz for 1 minute between current-carrying parts and case  |                      |                      |
| Vibration resistance                              |                           | Destruction: 10 to 55 Hz, 1.5-mm double amplitude for 2 hours each in X, Y, and Z directions                        |                      |                      |
| Shock resistance                                  |                           | Destruction: 1,000 m/s <sup>2</sup> 10 times each in X, Y, and Z directions   |                      |                      |
| Degree of protection                              |                           | IEC 60529 IP67, in-house standards: oil-resistant   |                      |                      |
| Connection method                                 |                           | Pre-wired Models (Standard cable length: 2 m)   |                      |                      |
| Weight (packed state)                             |                           | Approx. 80 g  | Approx. 140 g        | Approx. 190 g        |
| Materials   | Case                      | Nickel-plated brass   |                      |                      |
|   | Sensing surface           | PBT   |                      |                      |
|   | Clamping nuts             | Nickel-plated brass   |                      |                      |
|   | Toothed washer            | Zinc-plated iron  |                      |                      |
| Accessories                                       |                           | Instruction manual  |                      |                      |

\*1. The response frequency is an average value. Measurement conditions are as follows: standard sensing object, a distance of twice the standard sensing object, and a set distance of half the sensing distance.

\*2. Power Supply Voltage Waveform:

Use a sine wave for the power supply. Using a rectangular AC power supply may result in faulty reset.

# Engineering Data (Reference Value)

## Sensing Area

### Shielded Models

#### E2E-X□D□/-X□T1

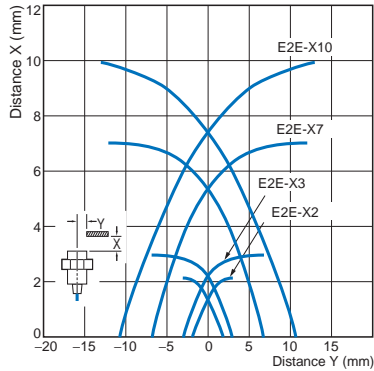

#### E2E-X□Y□

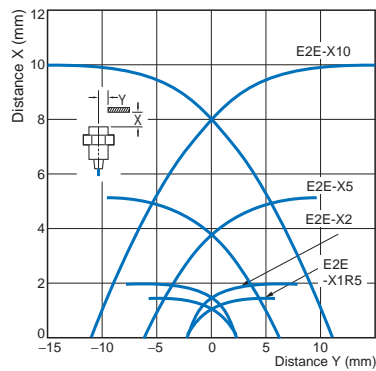

### Unshielded Models

#### E2E-X□MD□

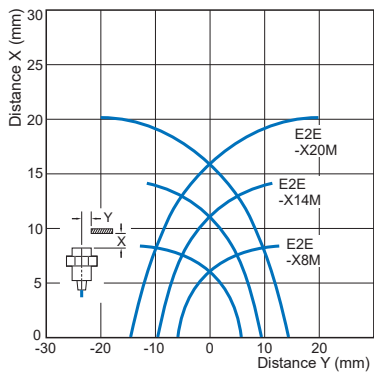

#### E2E-X□MY□

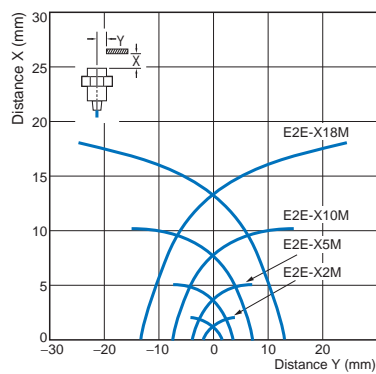

## Influence of Sensing Object Size and Material

#### E2E-X2D□

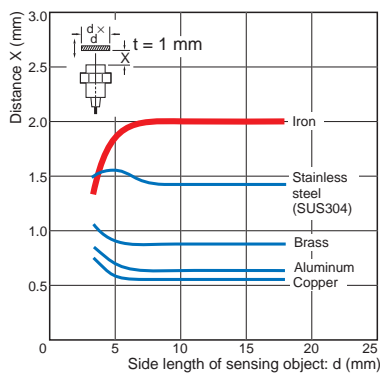

#### E2E-X3D□/-X3T1

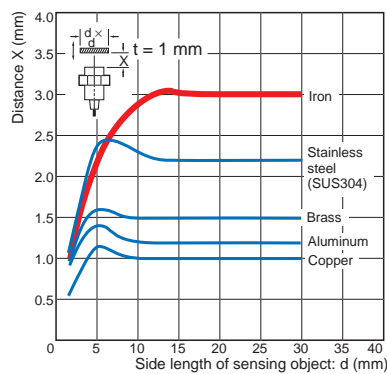

#### E2E-X7D□/-X7T1

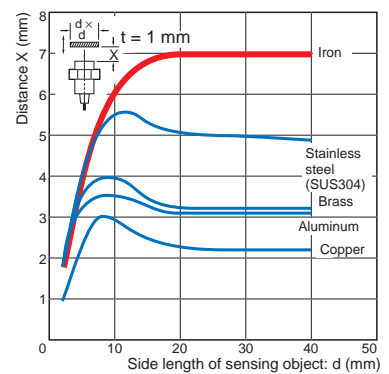

#### E2E-X10D□/-X10T1

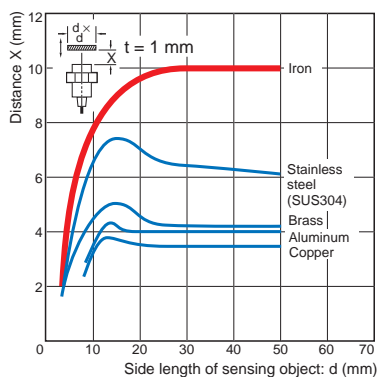

#### E2E-X8MD□

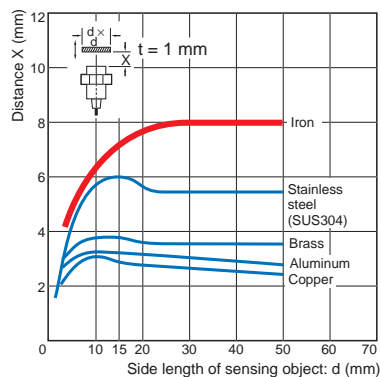

#### E2E-X14MD□

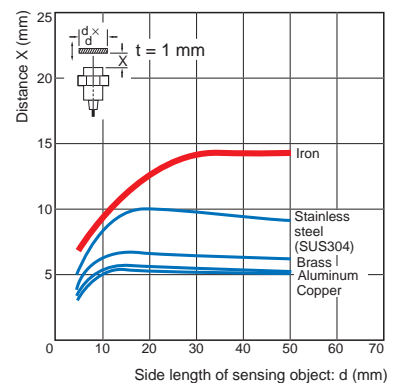

**E2E-X20MD**

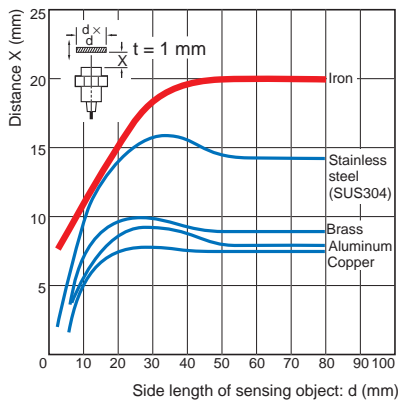

**E2E-X1R5Y**

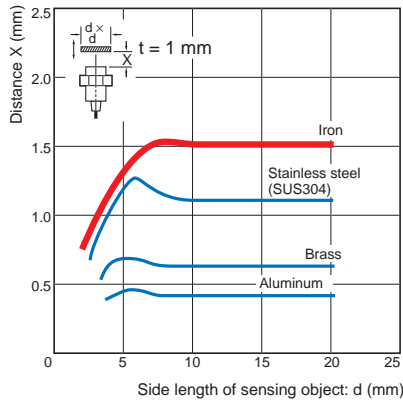

**E2E-X2Y**

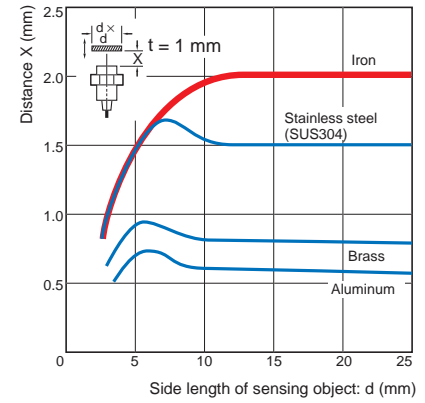

**E2E-X5Y**

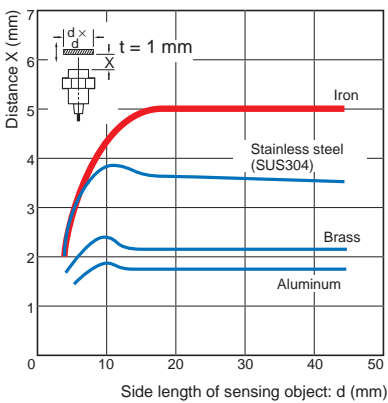

**E2E-X10Y**

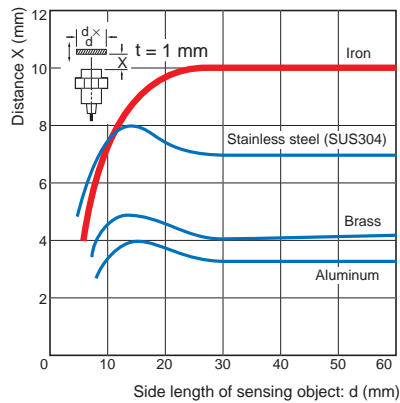

**E2E-X2MY**

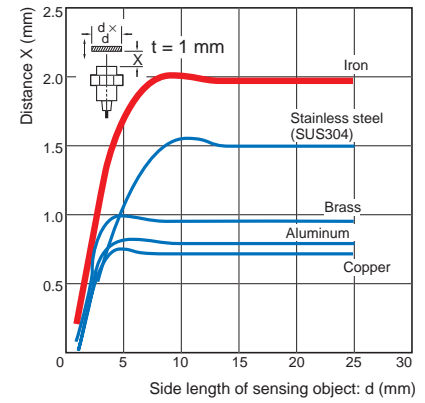

**E2E-X5MY**

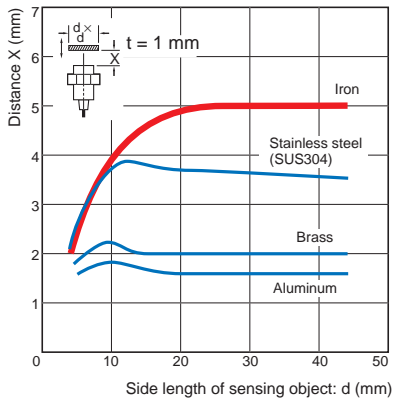

**E2E-X10MY**

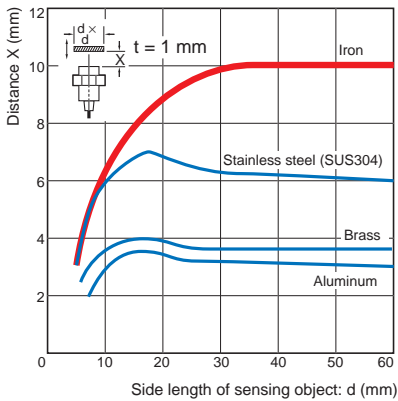

**E2E-X18MY**

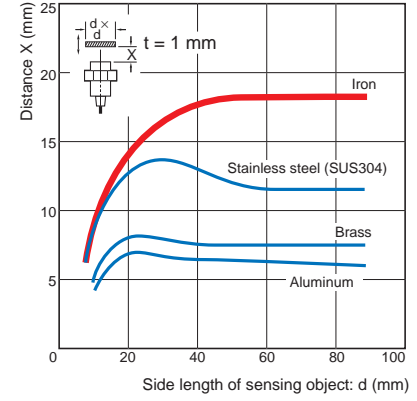

Leakage Current

E2E-X□D□

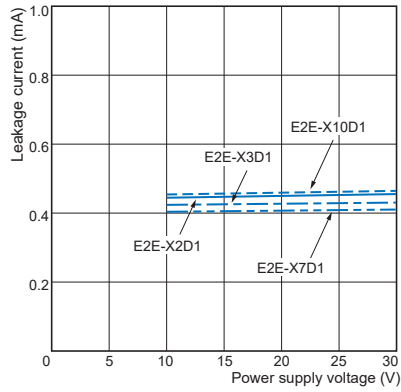

E2E-X□Y□

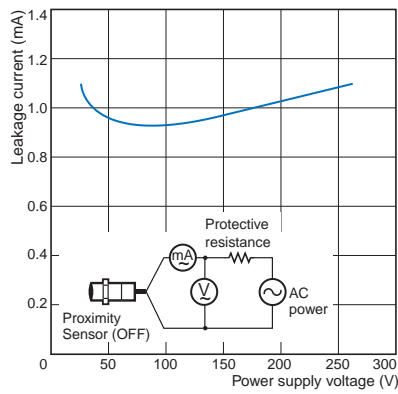

E2E-X□T1

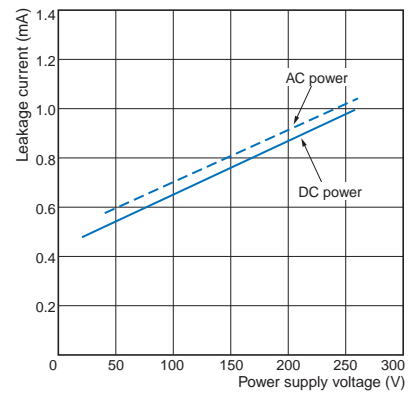

Residual Output Voltage

E2E-X□D□

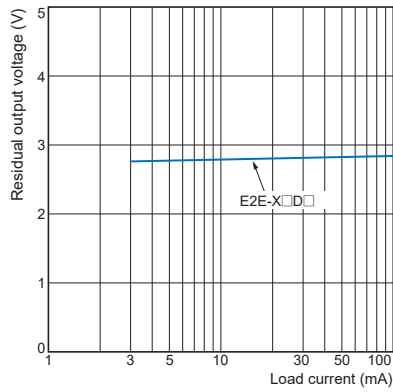

E2E-X□T1

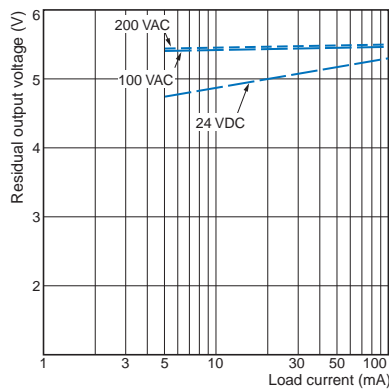

E2E-X□Y□ at 24 VAC

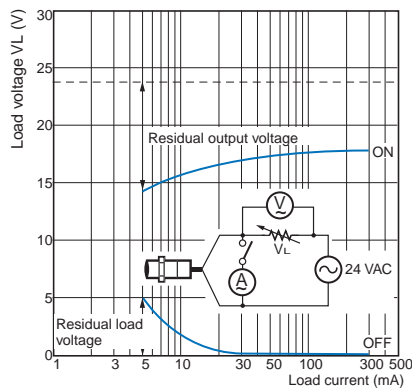

E2E-X□Y□ at 100 VAC

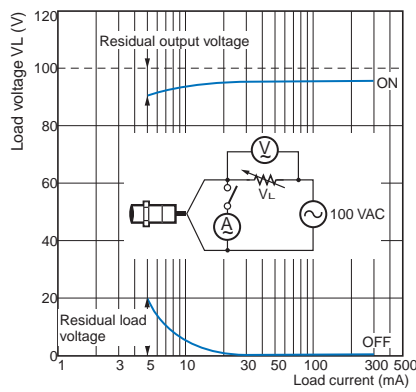

E2E-X□Y□ at 200 VAC

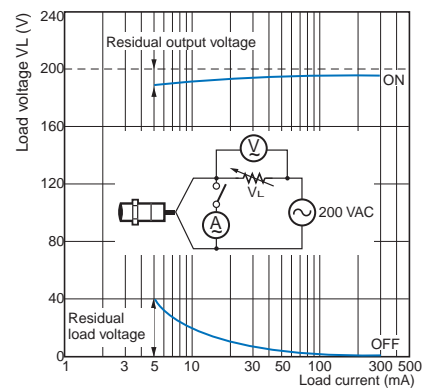

# I/O Circuit Diagrams

## DC 2-Wire

| Operation mode                                   | Model                             | Timing Chart   | Output circuit  |
|--|-----------------------------------|--|---|
| <p><b>Without self-diagnostic output: NO</b></p> | <p>E2E-X□D1(-M1TGJ)-U</p>         |  | <p>Note: The load can be connected to either the +V or 0 V side.</p>                            |
| <p><b>Without self-diagnostic output: NC</b></p> | <p>E2E-X□D2(-M1TGJ)-U</p>         |  | <p>Note: The load can be connected to either the +V or 0 V side.</p>                            |
| <p><b>With self-diagnostic output: NO</b></p>    | <p>E2E-X□D1S<br/>E2E-X□D1S-M1</p> | <p>* The diagnostic output is ON when there is a coil burnout or the sensing object is located in the unstable sensing area for 0.3 s or longer.</p> | <p>Note: Connect both the loads to the +V side of the control output and diagnostic output.</p> |

AC 2-Wire

| Operation mode | Model                   | Timing Chart | Output circuit   |
|----------------|-------------------------|--------------|--|
| NO             | E2E-X□Y□<br>E2E-X□Y□-M1 |              | <p>Note: For Connector Models, the connection between pins 3 and 4 uses an NO contact, and the connection between pins 1 and 2 uses an NC contact.</p> |
| NC             |                         |              |  |

AC/DC 2-Wire

| Operation mode | Model    | Timing Chart | Output circuit   |
|----------------|----------|--------------|--|
| NO             | E2E-X□T1 |              | <p>Note: The load can be connected to either the +V or 0 V side. There is no need to be concerned about the polarity (brown/blue) of the Proximity Sensor.</p> |

## Connections for Sensor I/O Connectors

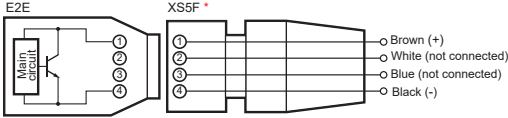
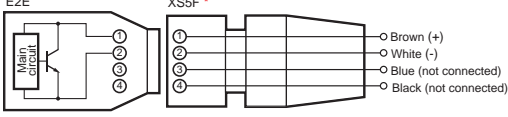
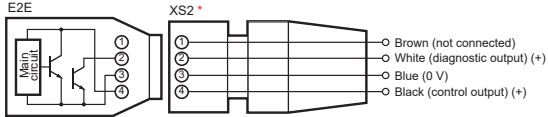
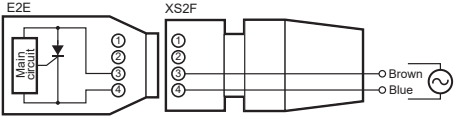
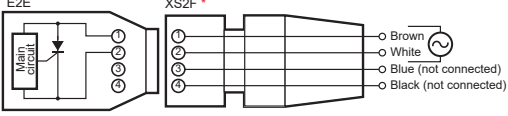
| Proximity Sensor                     |          |                |                  | Sensor I/O Connector Model                            | Connections  |
|--------------------------------------|----------|----------------|------------------|---|--|
| Type                                 | Polarity | Operation mode | Model            |   |  |
| DC 2-Wire (M12 Smartclick Connector) | Yes      | NO             | E2E-X□D1-M1TGJ-U | XS5F-D421-□80-P<br>XS5F-D422-□80-P<br>XS5W-D421-□81-P |  |
|                                      | Yes      | NC             | E2E-X□D2-M1TGJ-U |   |  |
| DC 2-Wire (M12 Screw Connector)      | Yes      | NO             | E2E-X□D1S-M1     | XS2F-D421-□80-F<br>XS2F-D422-□80-F<br>XS2W-D421-□81-F |  |
|                                      | ---      | NO             | E2E-X□Y1-M1      | XS2F-A421-□B0-F<br>XS2F-A422-□B0-F                    |  |
|                                      | ---      | NC             | E2E-X□Y2-M1      | XS2F-A421-□90-F                                       |  |

\* Different from Proximity Sensor wire colors.

Note: For details, refer to Sensor I/O Connectors/Sensor Controllers on your OMRON website.

## Safety Precautions

Refer to *Warranty and Limitations of Liability*.

### ⚠ WARNING

This product is not designed or rated for ensuring safety of persons either directly or indirectly. Do not use it for such purposes.



### ⚠ CAUTION

- Do not short the load. Explosion or burning may result.
- Do not supply power to the Sensor with no load, otherwise Sensor may be damaged.



### Precautions for Correct Use

Do not use this product under ambient conditions that exceed the ratings.

#### ● Design

#### Influence of Surrounding Metal

When mounting the Sensor within a metal panel, ensure that the clearances given in the following table are maintained. Failure to maintain these distances may cause deterioration in the performance of the Sensor.

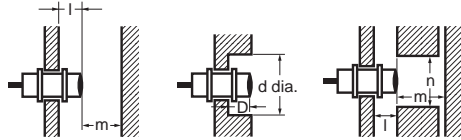

#### Influence of Surrounding Metal

(Unit: mm)

| Model                    | Item       | M8  | M12 | M18 | M30 |    |
|--------------------------|------------|-----|-----|-----|-----|----|
| DC 2-wire<br>E2E-X□D□    | l          | 0   |     |     |     |    |
|                          | d          | 8   | 12  | 18  | 30  |    |
|                          | D          | 0   |     |     |     |    |
|                          | m          | 4.5 | 8   | 20  | 40  |    |
|                          | n          | 12  | 18  | 27  | 45  |    |
| AC/DC 2-wire<br>E2E-X□T1 | l          | 15  |     |     |     |    |
|                          | d          | 40  |     |     |     |    |
|                          | D          | --- | 15  | 22  | 30  |    |
|                          | m          | 20  |     |     |     |    |
|                          | n          | 40  |     |     |     |    |
| AC 2-wire<br>E2E-X□Y□    | l          | 0   |     |     |     |    |
|                          | d          | 8   | 12  | 18  | 30  |    |
|                          | D          | 0   |     |     |     |    |
|                          | m          | 4.5 | 8   | 20  | 40  |    |
|                          | n          | 12  | 18  | 27  | 45  |    |
|                          | Unshielded | l   | 6   | 15  | 22  | 30 |
|                          |            | d   | 24  | 40  | 55  | 90 |
|                          |            | D   | 6   | 15  | 22  | 30 |
|                          |            | m   | 8   | 20  | 40  | 70 |
|                          |            | n   | 24  | 36  | 54  | 90 |

#### Relationship between Sizes and Models

| Model | Model      |                                     |
|-------|------------|-------------------------------------|
| M8    | Shielded   | E2E-X2D□<br>E2E-X1R5Y□              |
|       | Unshielded | E2E-X2MY□                           |
| M12   | Shielded   | E2E-X3D□<br>E2E-X2Y□<br>E2E-X3T1    |
|       | Unshielded | E2E-X8MD□<br>E2E-X5MY□              |
| M18   | Shielded   | E2E-X7D□<br>E2E-X5Y□<br>E2E-X7T1    |
|       | Unshielded | E2E-X14MD□<br>E2E-X10MY□            |
| M30   | Shielded   | E2E-X10D□<br>E2E-X10Y□<br>E2E-X10T1 |
|       | Unshielded | E2E-X20MD□<br>E2E-X18MY□            |



**Mutual Interference**

When installing Sensors face-to-face or side-by-side, ensure that the minimum distances given in the following table are maintained.

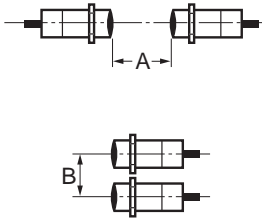

**Mutual Interference**

(Unit: mm)

| Model                    | Item       | M8 | M12 | M18       | M30       |           |
|--------------------------|------------|----|-----|-----------|-----------|-----------|
| DC 2-wire<br>E2E-X□D□    | Shielded   | A  | 20  | 30 (20)   | 50 (30)   | 100 (50)  |
|                          |            | B  | 15  | 20 (12) * | 35 (18) * | 70 (35)   |
| AC/DC 2-wire<br>E2E-X□T1 | Unshielded | A  | 80  | 120 (60)  | 200 (100) | 300 (100) |
|                          |            | B  | 60  | 100 (50)  | 110 (60)  | 200 (100) |
| AC 2-wire<br>E2E-X□Y□    | Shielded   | A  | 20  | 30 (20)   | 50 (30)   | 100 (50)  |
|                          |            | B  | 15  | 20 (12) * | 35 (18) * | 70 (35)   |
|                          | Unshielded | A  | 80  | 120 (60)  | 200 (100) | 300 (100) |
|                          |            | B  | 60  | 100 (50)  | 110 (60)  | 200 (100) |

Note: Values in parentheses apply to Sensors operating at different frequencies.  
 \* Mutual interference will not occur for close-proximity mounting if models with different frequencies are used together.

**Loads with Large Surge Currents (E2E-X□T□)**

If a load with a large surge current is connected, such as a relay, lamp, or motor, the surge current may cause the load short-circuit protection circuit to operate, resulting in operating errors.

**● Mounting**

**Tightening Force**

Do not tighten the nut with excessive force. A washer must be used with the nut.

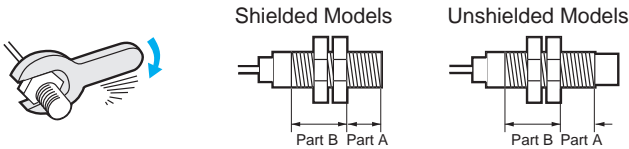

Note: 1. The allowable tightening strength depends on the distance from the edge of the head, as shown in the following table. (A is the distance from the edge of the head. B includes the nut on the head side. If the edge of the nut is in part A, the tightening torque for part A applies instead.)  
 2. The following strengths assume washers are being used.

| Model |            | Part A    |         | Part B |
|-------|------------|-----------|---------|--------|
|       |            | Dimension | Torque  | Torque |
| M8    | Shielded   | 9         | 9 N·m   | 12 N·m |
|       | Unshielded | 3         |         |        |
| M12   |            |           | 30 N·m  |        |
| M18   |            |           | 70 N·m  |        |
| M30   |            |           | 180 N·m |        |

**Connecting a DC 2-Wire Proximity Sensor to a PLC (Programmable Controller)**

**Required Conditions**

Connection to a PLC is possible if the specifications of the PLC and the Proximity Sensor satisfy the following conditions. (The meanings of the symbols are given at the right.)

- The ON voltage of the PLC and the residual voltage of the Proximity Sensor must satisfy the following.  
 $V_{ON} \leq V_{CC} - V_R$
- The OFF current of the PLC and the leakage current of the Proximity Sensor must satisfy the following.  
 $I_{OFF} \geq I_{leak}$   
 (If the OFF current is not listed in the PLC's input specifications, take it to be **1.3 mA**.)
- The ON current of the PLC and the control output of the Proximity Sensor must satisfy the following.  
 $I_{OUT} (min.) \leq I_{ON} \leq I_{OUT} (max.)$

The ON current of the PLC will vary, however, with the power supply voltage and the input impedance, as shown in the following equation.

$$I_{ON} = (V_{CC} - V_R - \underline{V_{PC}}) / R_{IN}$$

**Example**

In this example, the above conditions are checked when the Proximity Sensor is the E2E-X7D1-U and the power supply voltage is 24 V.

- $V_{ON} (14.4 V) \leq V_{CC} (20.4 V) - V_R (3 V) = 17.4 V$ : OK
- $I_{OFF} (1.3 mA) \geq I_{leak} (0.8 mA)$ : OK
- $I_{ON} = [V_{CC} (20.4 V) - V_R (3 V) - \underline{V_{PC}} (4 V)] / R_{IN} (3 k\Omega) = \text{Approx. } 4.5 \text{ mA}$

Therefore,  $I_{OUT} (min.) (3 mA) \leq I_{ON} (4.5 mA)$ : OK  
 Connection is thus possible.

**Connection Example (Reference)**

|                         |  |
|-------------------------|--|
| <b>PLC</b>              | $V_{ON}$ : ON voltage (14.4 V)<br>$I_{ON}$ : ON current (typically 7 mA)<br>$I_{OFF}$ : OFF current (1.3 mA)<br>$R_{IN}$ : Input impedance (3 k $\Omega$ )<br>$V_{PC}$ : Internal residual voltage (4 V) |
| <b>Proximity Sensor</b> | $V_R$ : Output residual voltage (3 V)<br>$I_{leak}$ : Leakage current (0.8 mA)<br>$I_{OUT}$ : Control output (3 to 100 mA)<br>$V_{CC}$ : Power supply voltage (PLC: 20.4 to 26.4 V)                      |

Dimensions

(Unit: mm)  
Tolerance class IT16 applies to dimensions in this data sheet unless otherwise specified.

Sensors

DC 2-Wire

No Self-diagnosis Output, PUR Cable models

Pre-wired Models (Shielded)

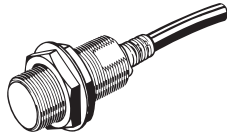

Pre-wired Connector Models (Shielded)

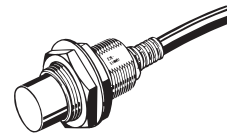

E2E-X2D□-U

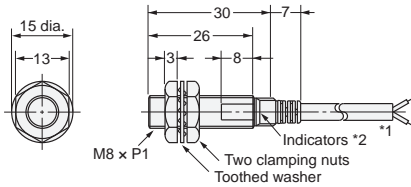

\*1. 4-dia. polyurethane-insulated round cable with 2 conductors (Conductor cross section: 0.3 mm<sup>2</sup>, Insulator diameter: 1.3 mm), Standard length: 2 m  
The cable can be extended up to 200 m (separate metal conduit).  
\*2. D1 Models: Operation indicator (red) and setting indicator (green), D2 Models: Operation indicator (red)

E2E-X2D□-M1TGJ-U

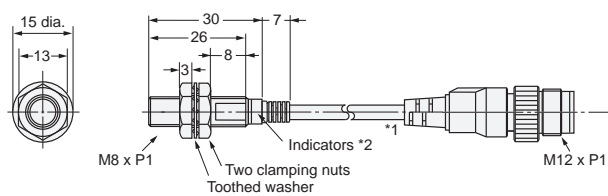

\*1. 4-dia. Polyurethane insulated round cable, Standard length: 0.3 m  
\*2. D1 Models: Operation indicator (red) and Setting indicator (green), D2 Models: Operation indicator (red)

E2E-X3D□-U

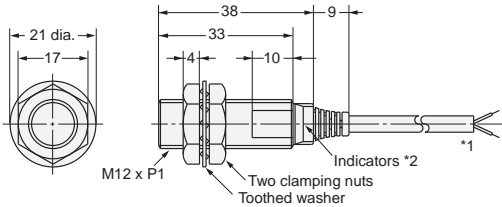

\*1. 4-dia. polyurethane-insulated round cable with 2 conductors (Conductor cross section: 0.3 mm<sup>2</sup>, Insulator diameter: 1.3 mm), Standard length: 2 m  
The cable can be extended (separate metal conduit) up to 200 m for the control output.  
\*2. D1 Models: Operation indicator (red) and setting indicator (green), D2 Models: Operation indicator (red)

E2E-X3D□-M1TGJ-U

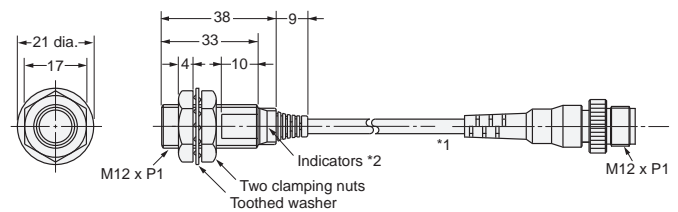

\*1. 4-dia. Polyurethane insulated round cable, Standard length: 0.3 m  
\*2. D1 Models: Operation indicator (red) and Setting indicator (green), D2 Models: Operation indicator (red)

E2E-X7D□-U

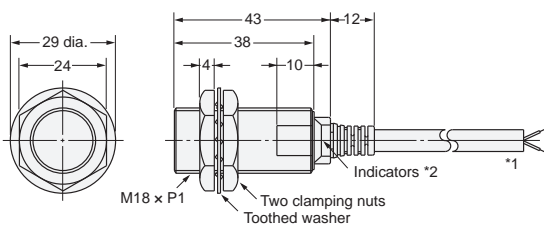

\*1. 6-dia. polyurethane-insulated round cable with 2 conductors (Conductor cross section: 0.5 mm<sup>2</sup>, Insulator diameter: 1.9 mm), Standard length: 2 m  
The cable can be extended (separate metal conduit) up to 200 m for the control output.  
\*2. D1 Models: Operation indicator (red) and setting indicator (green), D2 Models: Operation indicator (red)

E2E-X7D□-M1TGJ-U

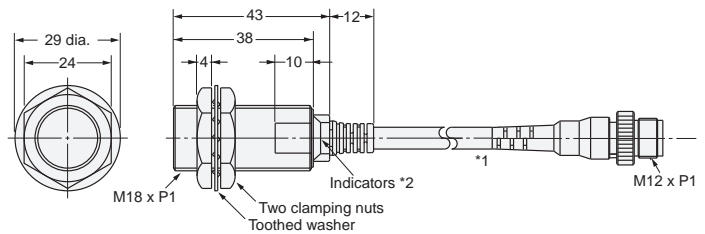

\*1. 6-dia. Polyurethane insulated round cable, Standard length: 0.3 m  
\*2. D1 Models: Operation indicator (red) and Setting indicator (green), D2 Models: Operation indicator (red)

E2E-X10D□-U

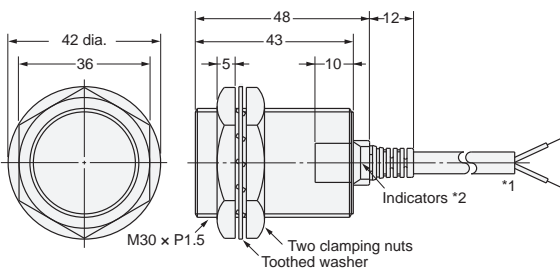

\*1. 6-dia. polyurethane-insulated round cable with 2 conductors (Conductor cross section: 0.5 mm<sup>2</sup>, Insulator diameter: 1.9 mm), Standard length: 2 m  
The cable can be extended (separate metal conduit) up to 200 m for the control output.  
\*2. D1 Models: Operation indicator (red) and setting indicator (green), D2 Models: Operation indicator (red)

E2E-X10D□-M1TGJ-U

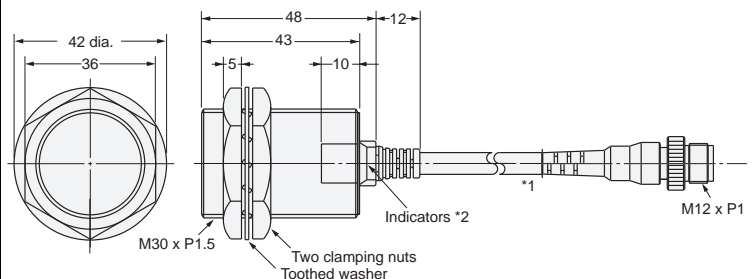

\*1. 6-dia. Polyurethane insulated round cable, Standard length: 0.3 m  
\*2. D1 Models: Operation indicator (red) and Setting indicator (green), D2 Models: Operation indicator (red)

Mounting Hole Dimensions

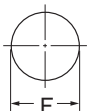

| Dimensions | M8                                    | M12                                    | M18                                    | M30                                    |
|------------|---------------------------------------|--|--|--|
| F (mm)     | 8.5 <sup>+0.5</sup> <sub>0</sub> dia. | 12.5 <sup>+0.5</sup> <sub>0</sub> dia. | 18.5 <sup>+0.5</sup> <sub>0</sub> dia. | 30.5 <sup>+0.5</sup> <sub>0</sub> dia. |

**DC 2-Wire  
Self-diagnosis Output models**

**Pre-wired Models  
(Shielded)**

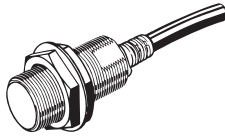

**Pre-wired Models  
(Unshielded)**

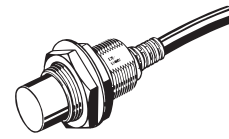

**E2E-X3D1S**

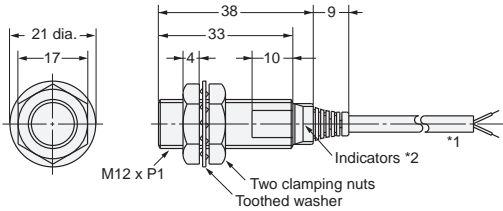

\*1. 4-dia. polyurethane-insulated round cable with 2 conductors (Conductor cross section: 0.3 mm<sup>2</sup>, Insulator diameter: 1.3 mm), Standard length: 2 m  
The cable can be extended (separate metal conduit) up to 200 m for the control output and up to 100 m for the diagnostic output.  
\*2. Operation indicator (red) and setting indicator (green)

**E2E-X8MD1S**

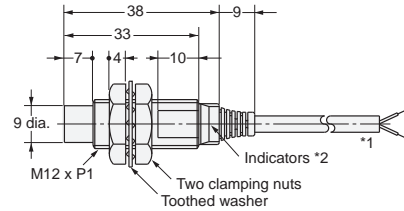

\*1. 4-dia. polyurethane-insulated round cable with 2 conductors (Conductor cross section: 0.3 mm<sup>2</sup>, Insulator diameter: 1.3 mm), Standard length: 2 m  
The cable can be extended (separate metal conduit) up to 200 m for the control output and up to 100 m for the diagnostic output.  
\*2. Operation indicator (red) and setting indicator (green)

**E2E-X7D1S**

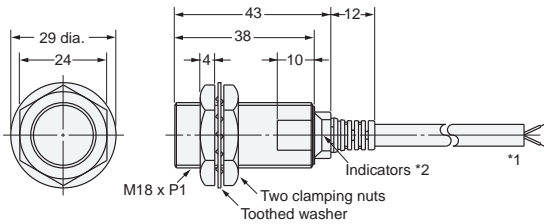

\*1. 6-dia. polyurethane-insulated round cable with 2 conductors (Conductor cross section: 0.5 mm<sup>2</sup>, Insulator diameter: 1.9 mm), Standard length: 2 m  
The cable can be extended (separate metal conduit) up to 200 m for the control output and up to 100 m for the diagnostic output.  
\*2. Operation indicator (red) and setting indicator (green)

**E2E-X14MD1S**

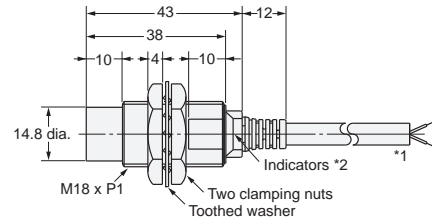

\*1. 6-dia. polyurethane-insulated round cable with 2 conductors (Conductor cross section: 0.5 mm<sup>2</sup>, Insulator diameter: 1.9 mm), Standard length: 2 m  
The cable can be extended (separate metal conduit) up to 200 m for the control output and up to 100 m for the diagnostic output.  
\*2. Operation indicator (red) and setting indicator (green)

**E2E-X10D1S**

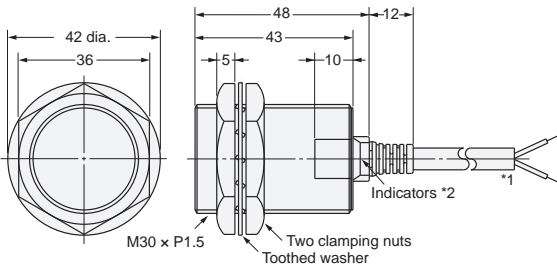

\*1. 6-dia. polyurethane-insulated round cable with 2 conductors (Conductor cross section: 0.5 mm<sup>2</sup>, Insulator diameter: 1.9 mm), Standard length: 2 m  
The cable can be extended (separate metal conduit) up to 200 m for the control output and up to 100 m for the diagnostic output.  
\*2. Operation indicator (red) and setting indicator (green)

**E2E-X20MD1S**

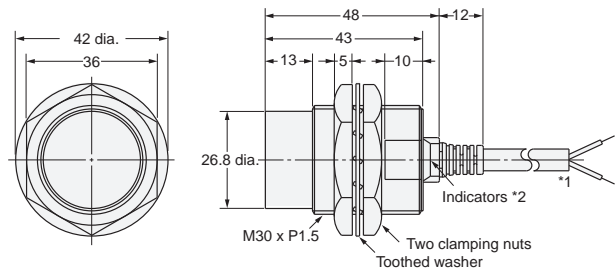

\*1. 6-dia. polyurethane-insulated round cable with 2 conductors (Conductor cross section: 0.5 mm<sup>2</sup>, Insulator diameter: 1.9 mm), Standard length: 2 m  
The cable can be extended (separate metal conduit) up to 200 m for the control output and up to 100 m for the diagnostic output.  
\*2. Operation indicator (red) and setting indicator (green)

**Mounting Hole Dimensions**

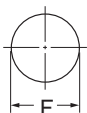

| Dimension | M12                       | M18                       | M30                       |
|-----------|---------------------------|---------------------------|---------------------------|
| F (mm)    | 12.5 <sup>+0.5</sup> dia. | 18.5 <sup>+0.5</sup> dia. | 30.5 <sup>+0.5</sup> dia. |

**Sensors**  
**DC 2-Wire**  
**Self-diagnosis Output models**

**M12 Connector Models (Shielded)**

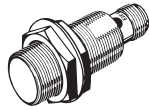

**M12 Connector Models (Unshielded)**

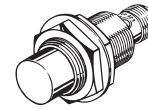

**E2E-X3D1S-M1**

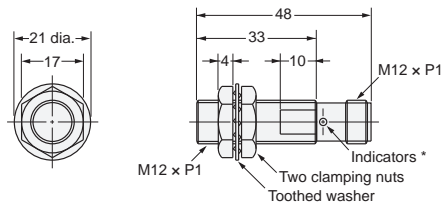

\* Operation indicator (red), Setting indicator (green)

**E2E-X8MD1S-M1**

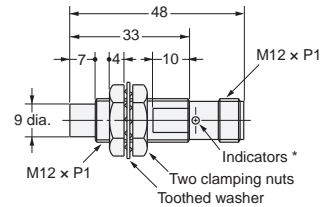

\* Operation indicator (red), Setting indicator (green)

**E2E-X7D1S-M1**

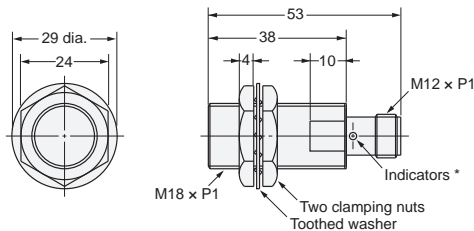

\* Operation indicator (red), Setting indicator (green)

**E2E-X14MD1S-M1**

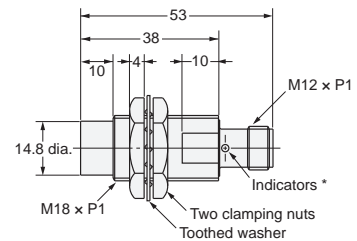

\* Operation indicator (red), Setting indicator (green)

**E2E-X10D1S-M1**

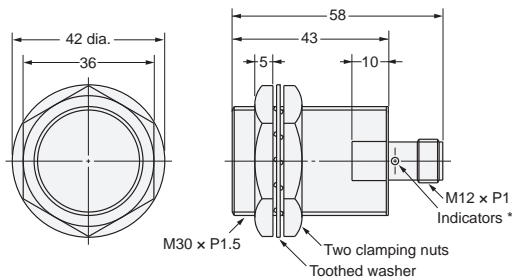

\* Operation indicator (red), Setting indicator (green)

**E2E-X20MD1S-M1**

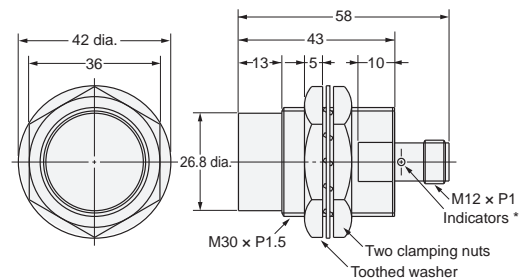

\* Operation indicator (red), Setting indicator (green)

**Mounting Hole Dimensions**



| Dimension | M12                                    | M18                                    | M30                                    |
|-----------|--|--|--|
| F (mm)    | 12.5 <sup>+0.5</sup> <sub>0</sub> dia. | 18.5 <sup>+0.5</sup> <sub>0</sub> dia. | 30.5 <sup>+0.5</sup> <sub>0</sub> dia. |

AC 2-Wire

Pre-wired Models  
(Shielded)

Pre-wired Models  
(Unshielded)

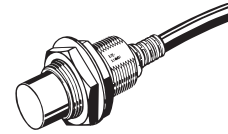

E2E-X1R5Y□

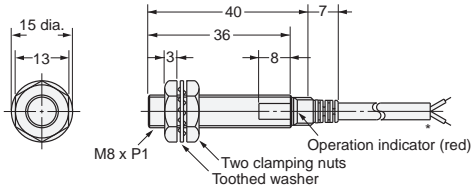

\* 4-dia. vinyl-insulated round cable with 2 conductors (Conductor cross section: 0.3 mm<sup>2</sup>, Insulator, diameter: 1.3 mm), Standard length: 2 m  
The cable can be extended up to 200 m (separate metal conduit).

E2E-X2MY□

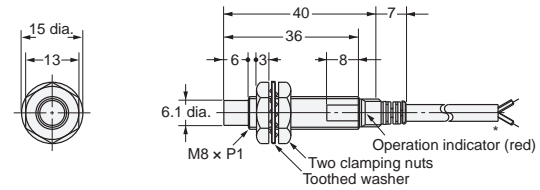

\* 4-dia. vinyl-insulated round cable with 2 conductors (Conductor cross section: 0.3 mm<sup>2</sup>, Insulator, diameter: 1.3 mm), Standard length: 2 m  
The cable can be extended up to 200 m (separate metal conduit).

E2E-X2Y□

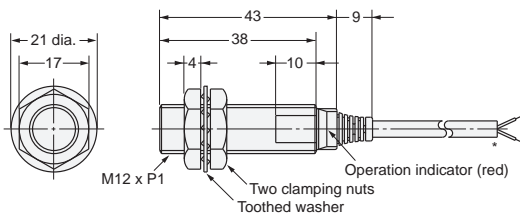

\* 4-dia. vinyl-insulated round cable with 2 conductors (Conductor cross section: 0.3 mm<sup>2</sup>, Insulator, diameter: 1.3 mm), Standard length: 2 m  
The cable can be extended up to 200 m (separate metal conduit).

E2E-X5MY□

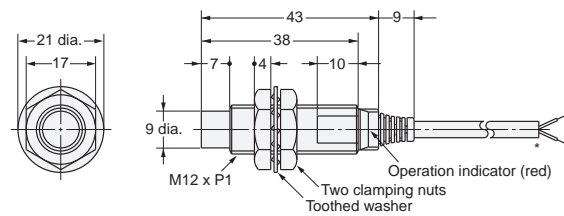

\* 4-dia. vinyl-insulated round cable with 2 conductors (Conductor cross section: 0.3 mm<sup>2</sup>, Insulator, diameter: 1.3 mm), Standard length: 2 m  
The cable can be extended up to 200 m (separate metal conduit).

E2E-X5Y□

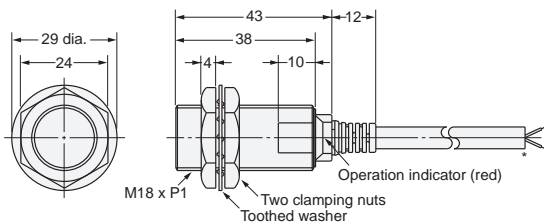

\* 6-dia. vinyl-insulated round cable with 2 conductors (Conductor cross section: 0.5 mm<sup>2</sup>, Insulator, diameter: 1.9 mm), Standard length: 2 m  
The cable can be extended up to 200 m (separate metal conduit).

E2E-X10MY□

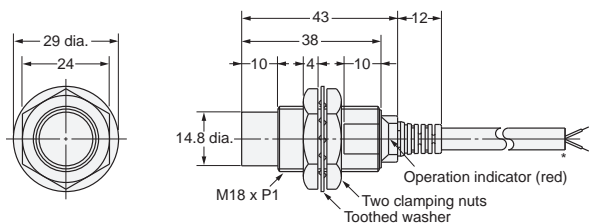

\* 6-dia. vinyl-insulated round cable with 2 conductors (Conductor cross section: 0.5 mm<sup>2</sup>, Insulator, diameter: 1.9 mm), Standard length: 2 m  
The cable can be extended up to 200 m (separate metal conduit).

E2E-X10Y□

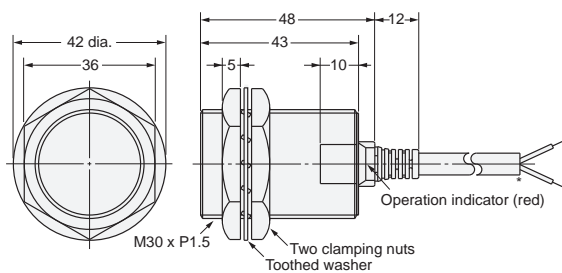

\* 6-dia. vinyl-insulated round cable with 2 conductors (Conductor cross section: 0.5 mm<sup>2</sup>, Insulator, diameter: 1.9 mm), Standard length: 2 m  
The cable can be extended up to 200 m (separate metal conduit).

E2E-X18MY□

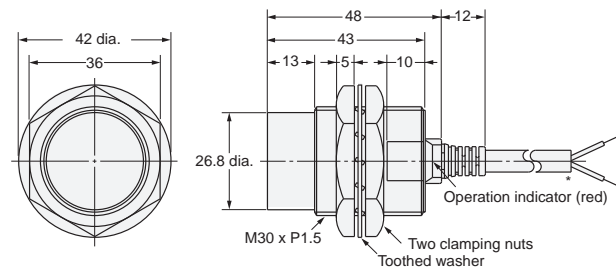

\* 6-dia. vinyl-insulated round cable with 2 conductors (Conductor cross section: 0.5 mm<sup>2</sup>, Insulator, diameter: 1.9 mm), Standard length: 2 m  
The cable can be extended up to 200 m (separate metal conduit).

Mounting Hole Dimensions

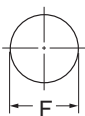

| Dimensions | M8                                    | M12                                    | M18                                    | M30                                    |
|------------|---------------------------------------|--|--|--|
| F (mm)     | 8.5 <sup>+0.5</sup> <sub>0</sub> dia. | 12.5 <sup>+0.5</sup> <sub>0</sub> dia. | 18.5 <sup>+0.5</sup> <sub>0</sub> dia. | 30.5 <sup>+0.5</sup> <sub>0</sub> dia. |

**Sensors**  
**AC 2-Wire**

**M12 Connector Models**  
**(Shielded)**

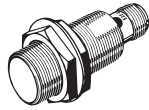

**M12 Connector Models**  
**(Unshielded)**

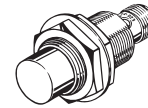

**E2E-X2Y□-M1**

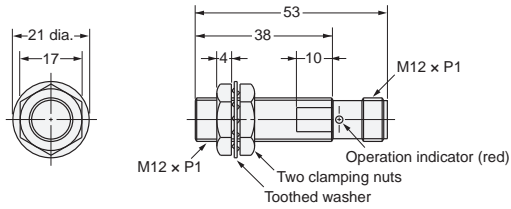

**E2E-X5MY□-M1**

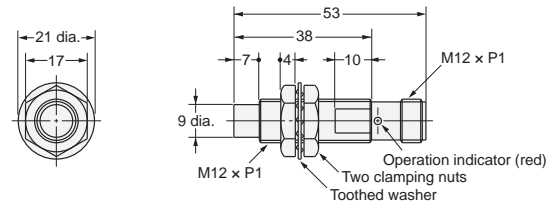

**E2E-X5Y□-M1**

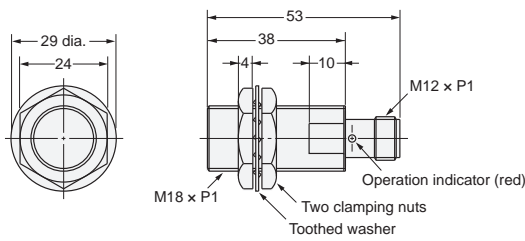

**E2E-X10MY□-M1**

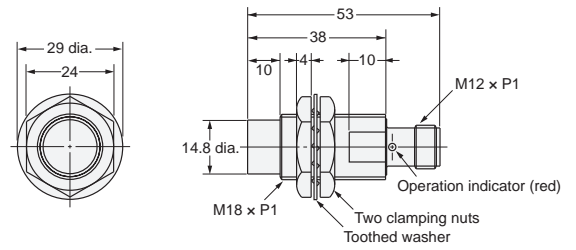

**E2E-X10Y□-M1**

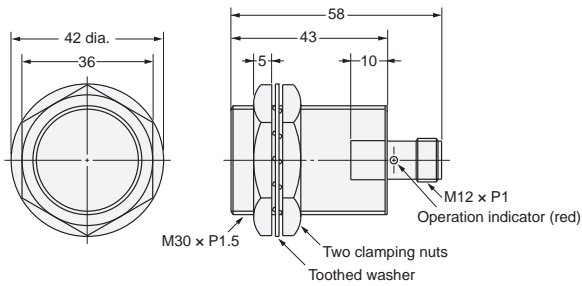

**E2E-X18MY□-M1**

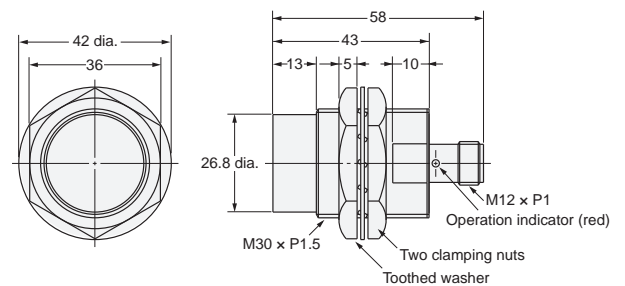

**Mounting Hole Dimensions**



| Dimension | M12                       | M18                       | M30                       |
|-----------|---------------------------|---------------------------|---------------------------|
| F (mm)    | 12.5 <sup>+0.5</sup> dia. | 18.5 <sup>+0.5</sup> dia. | 30.5 <sup>+0.5</sup> dia. |

AC/DC 2-Wire

Pre-wired Models  
(Shielded)

E2E-X3T1

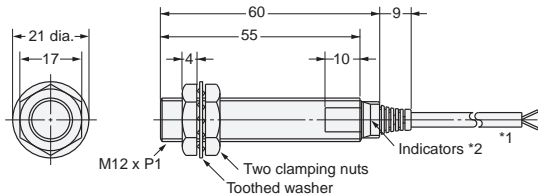

- \*1. 4-dia. vinyl-insulated round cable with 2 conductors (Conductor cross section: 0.3 mm<sup>2</sup>, Insulator diameter: 1.3 mm), Standard length: 2 m. The cable can be extended up to 200 m (separate metal conduit).
- \*2. Operation indicator (red), Setting indicator (green)

E2E-X7T1

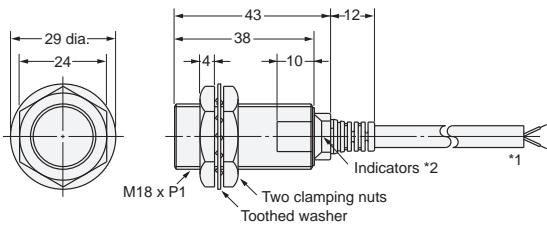

- \*1. 6-dia. vinyl-insulated round cable with 2 conductors (Conductor cross section: 0.5 mm<sup>2</sup>, Insulator diameter: 1.9 mm), Standard length: 2 m. The cable can be extended (separate metal conduit) up to 200 m for the control output and up to 100 m for the diagnostic output.
- \*2. Operation indicator (red), Setting indicator (green)

E2E-X10T1

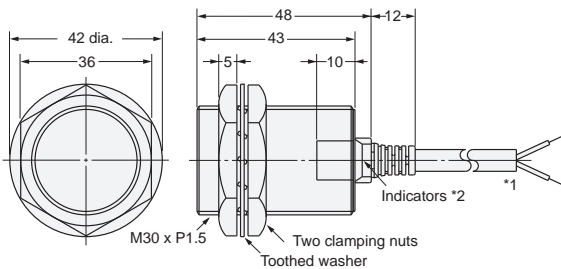

- \*1. 6-dia. vinyl-insulated round cable with 2 conductors (Conductor cross section: 0.5 mm<sup>2</sup>, Insulator diameter: 1.9 mm), Standard length: 2 m. The cable can be extended (separate metal conduit) up to 200 m for the control output and up to 100 m for the diagnostic output.
- \*2. Operation indicator (red), Setting indicator (green)

Mounting Hole Dimensions

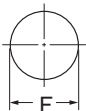

| Dimensions | M12                                    | M18                                    | M30                                    |
|------------|--|--|--|
| F (mm)     | 12.5 <sup>+0.5</sup> <sub>0</sub> dia. | 18.5 <sup>+0.5</sup> <sub>0</sub> dia. | 30.5 <sup>+0.5</sup> <sub>0</sub> dia. |

Dimensions for Proximity Sensors with Sensor I/O Connectors

Shielded Models

Unshielded Models

Straight Connectors

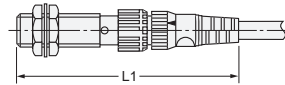

Straight Connectors

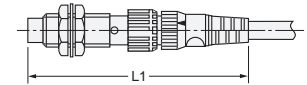

L-shape Connectors

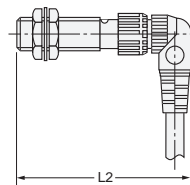

L-shape Connectors

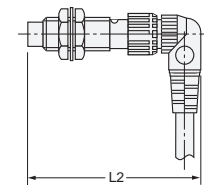

Dimensions with the XS2F Connected

(Unit: mm)

| Dimension       |    | L1         | L2         |
|-----------------|----|------------|------------|
| Sensor diameter |    |            |            |
| M8              |    | Approx. 75 | Approx. 62 |
| M12*            | DC | Approx. 80 | Approx. 67 |
|                 | AC | Approx. 85 | Approx. 72 |
| M18             |    | Approx. 85 | Approx. 72 |
| M30             |    | Approx. 90 | Approx. 77 |

\* The overall length of the Sensor is different between AC and DC Models for Sensors with diameters of M12. This will change the dimension when the I/O Connector is connected.

Mounting Brackets

Protective Covers

Sputter Protective Covers

Refer to Y92□ for details.

## Terms and Conditions Agreement

### Read and understand this catalog.

Please read and understand this catalog before purchasing the products. Please consult your OMRON representative if you have any questions or comments.

### Warranties.

(a) Exclusive Warranty. Omron's exclusive warranty is that the Products will be free from defects in materials and workmanship for a period of twelve months from the date of sale by Omron (or such other period expressed in writing by Omron). Omron disclaims all other warranties, express or implied.

(b) Limitations. OMRON MAKES NO WARRANTY OR REPRESENTATION, EXPRESS OR IMPLIED, ABOUT NON-INFRINGEMENT, MERCHANTABILITY OR FITNESS FOR A PARTICULAR PURPOSE OF THE PRODUCTS. BUYER ACKNOWLEDGES THAT IT ALONE HAS DETERMINED THAT THE PRODUCTS WILL SUITABLY MEET THE REQUIREMENTS OF THEIR INTENDED USE.

Omron further disclaims all warranties and responsibility of any type for claims or expenses based on infringement by the Products or otherwise of any intellectual property right. (c) Buyer Remedy. Omron's sole obligation hereunder shall be, at Omron's election, to (i) replace (in the form originally shipped with Buyer responsible for labor charges for removal or replacement thereof) the non-complying Product, (ii) repair the non-complying Product, or (iii) repay or credit Buyer an amount equal to the purchase price of the non-complying Product; provided that in no event shall Omron be responsible for warranty, repair, indemnity or any other claims or expenses regarding the Products unless Omron's analysis confirms that the Products were properly handled, stored, installed and maintained and not subject to contamination, abuse, misuse or inappropriate modification. Return of any Products by Buyer must be approved in writing by Omron before shipment. Omron Companies shall not be liable for the suitability or unsuitability or the results from the use of Products in combination with any electrical or electronic components, circuits, system assemblies or any other materials or substances or environments. Any advice, recommendations or information given orally or in writing, are not to be construed as an amendment or addition to the above warranty.

See <http://www.omron.com/global/> or contact your Omron representative for published information.

### Limitation on Liability: Etc.

OMRON COMPANIES SHALL NOT BE LIABLE FOR SPECIAL, INDIRECT, INCIDENTAL, OR CONSEQUENTIAL DAMAGES, LOSS OF PROFITS OR PRODUCTION OR COMMERCIAL LOSS IN ANY WAY CONNECTED WITH THE PRODUCTS, WHETHER SUCH CLAIM IS BASED IN CONTRACT, WARRANTY, NEGLIGENCE OR STRICT LIABILITY.

Further, in no event shall liability of Omron Companies exceed the individual price of the Product on which liability is asserted.

### Suitability of Use.

Omron Companies shall not be responsible for conformity with any standards, codes or regulations which apply to the combination of the Product in the Buyer's application or use of the Product. At Buyer's request, Omron will provide applicable third party certification documents identifying ratings and limitations of use which apply to the Product. This information by itself is not sufficient for a complete determination of the suitability of the Product in combination with the end product, machine, system, or other application or use. Buyer shall be solely responsible for determining appropriateness of the particular Product with respect to Buyer's application, product or system. Buyer shall take application responsibility in all cases.

NEVER USE THE PRODUCT FOR AN APPLICATION INVOLVING SERIOUS RISK TO LIFE OR PROPERTY OR IN LARGE QUANTITIES WITHOUT ENSURING THAT THE SYSTEM AS A WHOLE HAS BEEN DESIGNED TO ADDRESS THE RISKS, AND THAT THE OMRON PRODUCT(S) IS PROPERLY RATED AND INSTALLED FOR THE INTENDED USE WITHIN THE OVERALL EQUIPMENT OR SYSTEM.

### Programmable Products.

Omron Companies shall not be responsible for the user's programming of a programmable Product, or any consequence thereof.

### Performance Data.

Data presented in Omron Company websites, catalogs and other materials is provided as a guide for the user in determining suitability and does not constitute a warranty. It may represent the result of Omron's test conditions, and the user must correlate it to actual application requirements. Actual performance is subject to the Omron's Warranty and Limitations of Liability.

### Change in Specifications.

Product specifications and accessories may be changed at any time based on improvements and other reasons. It is our practice to change part numbers when published ratings or features are changed, or when significant construction changes are made. However, some specifications of the Product may be changed without any notice. When in doubt, special part numbers may be assigned to fix or establish key specifications for your application. Please consult with your Omron's representative at any time to confirm actual specifications of purchased Product.

### Errors and Omissions.

Information presented by Omron Companies has been checked and is believed to be accurate; however, no responsibility is assumed for clerical, typographical or proofreading errors or omissions.