

E2C-EDA

Finally, a Digital Proximity Sensor!

- An impressive lineup of Sensor Heads to handle a wide variety of applications.
An array of Heads.
Flexible cables provided as a standard feature.
- High-resolution sensing unaffected by environmental swings. Excellent temperature characteristics at 0.08%/°C (5.4-mm dia. Sensor Head).
- Simple and reliable measurements with micron-level resolution.
Two clear, large, and easy-to-read digital displays.
- Support for high-resolution positioning and screening.
Fine positioning maximizes digital changes.



Proximity Sensors

Sensing Guide

⚠ Be sure to read *Safety Precautions* on page 858.

Cylindrical Models

Features

An Impressive Lineup of Sensor Heads to Handle a Wide Variety of Applications

An Array of Heads

The lineup includes some Sensor Heads as thin as 3 mm in diameter and others that are thin and flat. Narrow installation spaces are not a problem for these models. Still other Sensor Heads are heat resistant or rated IP67 for superior environmental resistance. These models are capable of high-resolution sensing even in harsh environments.



Flexible Cables Provided as a Standard Feature

With flexible cables connecting the Preamplifier to the Amplifier, installation on moving parts is never a problem. The twin-output models can also output an open-circuit alarm. In that rare instance where the cable breaks, the E2C-EDA can then send out an alarm that greatly simplifies the task of locating the faulty Sensor.

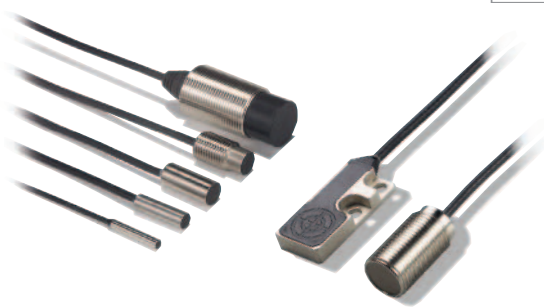
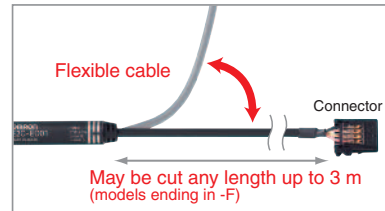

Industry Leader

High-resolution Sensing Unaffected by Environmental Swings

Excellent Temperature Characteristics at 0.08%/°C (5.4-mm-Dia. Sensor Head)

In addition to repeat accuracy of 1-μm or better, the temperature characteristics of the E2C-EDA are flat. This means that environmental factors, such as temperature swings in the morning and at night, will not affect high-resolution positioning and screening.

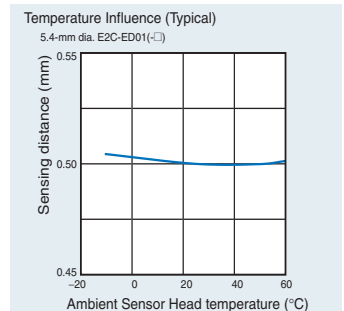

E2EC

E2C-EDA

E2C

/E2C-H

E2CY

Simple and Reliable Measurements with Micron-level Resolution. Industry First

Two Clear, Large, and Easy-to-Read Digital Displays.

The E2C-EDA features two large, easy-to-read digital displays. Since the digitized detected and threshold values can be checked at the same time, settings are simple and reliable for just about anyone. Various teaching methods are also available for settings that cannot be made consistently by different operators.

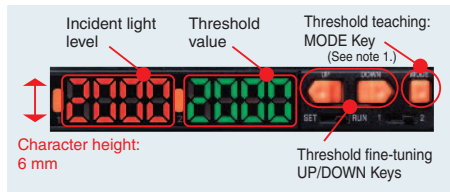

Note 1: The operation of the MODE Key can be changed during operation to teaching values, fine positioning, or zero resetting.

Digital Display Simplifies Installation and Settings

In the stable sensing zone, the E2C-EDA generally reads 1,500 or higher (see note 2).

This way you can tell at a glance whether the current installation and settings are within the optimal range.

Note 2: This reading is only a guideline because there may be some variation between Sensors. Also refer to the Engineering Data because values may vary with non-standard sensing objects.



Connector for Connecting Sensor Heads to Amplifiers

A Shielded Connector is used for more reliable wiring and easier cable handling. Since the press-fit connector allows repeat connections, wiring and head replacement are simple and reliable.

Support for High-resolution Positioning and Screening Patent Pending

Fine Positioning Maximizes Digital Changes

Fine Positioning maximizes changes in the digital value as you get closer to the sensing point. More precise sensing can be achieved by executing Fine Positioning with the workpiece positioned at the point to be maximized.

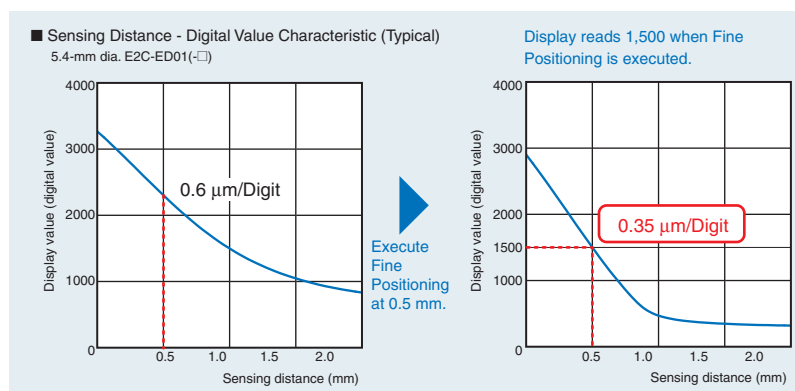

Proximity Sensors

Sensing Guide

Cylindrical Models

Rectangular Models

Separate Amp/Pre-wired Connector Models

Capacitive Models

Others

Peripheral Devices

General Information

E2EC

E2C-EDA

E2C

/E2C-H





E2CY

E2C-EDA

Ordering Information

Sensors

Sensor Heads

Type	Appearance	Sensing distance	Repeat accuracy	Model	
Cylindrical		3 dia. × 18 mm	0.6 mm	1 μm	E2C-EDR6-F *2
		5.4 dia. × 18 mm	1 mm	1 μm	E2C-ED01-□ *1*2*3
		8 dia. × 22 mm	2 mm	2 μm	E2C-ED02-□ *1*2*3
Shielded	Screw 	M10 × 22 mm	2 mm	2 μm	E2C-EM02-□ *1*2*3
Flat		30 × 14 × 4.8 mm	5 mm	2 μm	E2C-EV05-□ *1*2*3
Unshielded	Screw 	M18 × 46.3 mm	7 mm	5 μm	E2C-EM07M-□ *1*2*3
Heat-resistant	Screw 	M12 × 22 mm	2 mm	2 μm	E2C-EM02H *2

*1. A Protective Spiral Tube is provided with models ending in the suffix -S (example: E2C-ED01-S).

*2. Two cable lengths are available. (3-dia.: Free-cut, Heat-resistant Models: Standard-length only) Overall length of the Standard-length Models: 2.5 m, Length from the Sensor Head to the Pre-amplifier: 2.0 m (example: E2C-ED01). Overall length of Free-cut Models: 3.5 m, Length from the Sensor Head to the Pre-amplifier: 0.5 m for models ending in the suffix -F (example: E2C-ED01-F).

*3. Models ending in the suffix -S that come with Protective Spiral Tubes and Free-cut Models ending in the suffix -F are made-to-order products.

Amplifier Units

Pre-wired Models

Type	Appearance	Functions	Model	
			NPN output	PNP output
Advanced models		Area output, open circuit detection, differential operation	E2C-EDA11	E2C-EDA41
		Remote setting, differential operation	E2C-EDA21	E2C-EDA51

Connector Models

Type	Appearance	Functions	Model	
			NPN output	PNP output
Advanced models		Area output, open circuit detection, differential operation	E2C-EDA6	E2C-EDA8
		Remote setting, differential operation	E2C-EDA7	E2C-EDA9

Amplifier Unit Connectors (Order Separately)

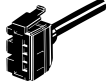
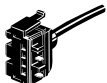
Name	Appearance	Cable length	No. of conductors	Model
Master Connector		2 m	4	E3X-CN21
Slave Connector			2	E3X-CN22

Proximity Sensors

Sensing Guide

Cylindrical Models

Rectangular Models

Separate Amp/Pre-wired Connector Models

Capacitive Models

Others

Peripheral Devices

General Information

E2EC

E2C-EDA

E2C/E2C-H

E2CY

Connector Ordering Precaution





Amplifier Units and Connectors are sold separately.
Refer to the following tables when placing an order.

Amplifier Unit			Applicable Connector (Order Separately)	
Model	NPN output	PNP output	Master Connector	Slave Connector
Advanced models	E2C-EDA6	E2C-EDA8	E3X-CN21	E3X-CN22
	E2C-EDA7	E2C-EDA9		

When Using 5 Amplifier Units

5 Amplifier Units	+	1 Master Connector	4 Slave Connectors
-------------------	---	--------------------	--------------------

Mobile Console (Order Separately)

Appearance	Model	Remarks
	E3X-MC11-SV2 (model number of set)	Mobile Console with Head, Cable, and AC adapter provided as accessories
	E3X-MC11-C1-SV2	Mobile Console
	E3X-MC11-H1	Head
	E39-Z12-1	Cable (1.5 m)

Note: Use the E3X-MC11-SV2 Mobile Console with E2C-EDA-series Amplifier Units. If you use a Mobile Console like the E3X-MC11-S, some functions may not operate. Refer to *Ratings/Characteristics* for the E3X-DA-S/MDA on page 69 for Amplifier Unit specifications.

Accessories (Order Separately)

Mounting Bracket

Appearance	Model	Quantity
	E39-L143	1

End Plate

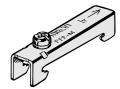
Appearance	Model	Quantity
	PFP-M	1

Proximity Sensors

Sensing Guide

Cylindrical Models

Rectangular Models

Separate Amp/Pre-wired Connector Models

Capacitive Models

Others

Peripheral Devices

General Information

E2EC

E2C-EDA

E2C
/E2C-H

E2CY

E2C-EDA

Ratings and Specifications

Sensor Heads

Model	E2C-EDR6-F	E2C-ED01(-□)	E2C-ED02(-□)	E2C-EM02(-□)	E2C-EM07M(-□)	E2C-EV05(-□)	E2C-EM02H		
Item	3 dia. × 18 mm	5.4 dia. × 18 mm	8 dia. × 22 mm	M10 × 22 mm	M18 × 46.3 mm	30 × 14 × 4.8 mm	M12 × 22 mm		
Sensing distance	0.6 mm	1 mm	2 mm		7 mm	5 mm	2 mm		
Sensing object	Ferrous metal (The sensing distance decreases with non-ferrous metal, refer to <i>Engineering Data</i> on pages 854 and 855.)								
Standard sensing object	5 × 5 × 3 mm		10 × 10 × 3 mm		22 × 22 × 3 mm	15 × 15 × 3 mm	20 × 20 × 3 mm		
	Material: Iron (S50C)								
Repeat accuracy *1	1 μm		2 μm		5 μm	2 μm			
Differential travel	Variable								
Temperature characteristic *1	Sensor Head	0.3%/°C	0.08%/°C			0.04%/°C	0.2%/°C		
	Preamplifier and Amplifier	0.08%/°C							
Ambient temperature *2	Operating	-10 to 60°C (with no icing or condensation)					-10 to 200°C *3		
	Storage	-10 to 60°C (with no icing or condensation)	-20 to 70°C (with no icing or condensation)						
Ambient humidity	Operating/Storage: 35% to 85% (with no condensation)								
Insulation resistance	50 MΩ min. at 500 VDC								
Dielectric strength	1,000 VAC, 50/60 Hz for 1 min between current-carrying parts and case								
Vibration resistance	Destruction: 10 to 55 Hz, 1.5-mm double amplitude for 2 hours each in X, Y, and Z directions								
Shock resistance	Destruction: 500 m/s ² 3 times each in X, Y, and Z directions								
Degree of protection	IEC 60529 IP67						IEC 60529 IP60 *4		
Connection method	Connector (Standard cable length: 2.5 m (2 m between Head and Preamplifier), "-F" model cable length: 3.5 m (0.5 m between Head and Preamplifier))								
Weight (packed state)	Approx. 120 g (Models with protective spiral tube (-S models) are approx. 90 g heavier.)								
Materials	Sensor Head	Case	Brass	Stainless steel	Brass	Zinc	Brass		
		Sensing surface	Heat-resistant ABS					PEEK	
		Clamping nuts	---			Brass, nickel-plated	---		Brass, nickel-plated
		Toothed washer	---			Zinc-plated iron	---		Zinc-plated iron
	Preamplifier	PES							
Accessories	Preamplifier Mounting Brackets, instruction manual								

*1. The repeat accuracy and temperature characteristic are for a standard sensing object positioned midway through the rated sensing distance.

*2. A sudden temperature rise even within the rated temperature range may degrade characteristics.

*3. For the Sensor Head only without the preamplifier (-10 to 60°C). With no icing or condensation.

*4. Do not operate the Sensor in areas exposed to water vapor because the enclosure is not waterproof.

E2EC

E2C-EDA

E2C
/E2C-H

E2CY

Amplifier Units

Model		Advanced Models with Twin Outputs		Advanced Models with External Inputs	
Model	NPN output	E2C-EDA11	E2C-EDA6	E2C-EDA21	E2C-EDA7
Item	PNP output	E2C-EDA41	E2C-EDA8	E2C-EDA51	E2C-EDA9
Power supply voltage		12 to 24 VDC \pm 10%, ripple (p-p): 10% max.			
Power consumption		1,080 mW max. (Current consumption: 45 mA at power supply voltage of 24 VDC)			
Control output		Load power supply voltage: 26.4 VDC max., Open-collector output (NPN or PNP depending on model), Load current: 50 mA max. (Residual voltage: 1 V max.)			
Re-sponse time	Super-high-speed mode *	Operate or reset: 150 μ s max.			
	High-speed mode	Operate or reset: 300 μ s max.			
	Standard mode	Operate or reset: 1 ms max.			
	High-resolution mode	Operate or reset: 4 ms max.			
Func-tions	Differential detection	Switchable between single edge and double edge detection mode. Single edge: Can be set to 300 μ s, 500 μ s, 1 ms, 10 ms, or 100 ms. Double edge: Can be set to 500 μ s, 1 ms, 2 ms, 20 ms, or 200 ms.			
	Timer	Select from OFF-delay, ON-delay, or one-shot timer. 1 ms to 5 s (1 to 20 ms set in 1-ms increments, 20 to 200 ms set in 10-ms increments, 200 ms to 1 s set in 100-ms increments, and 1 to 5 s set in 1 s-increments)			
	Zero-reset	Negative values can be displayed. (Threshold is not shifted.)			
	Initial reset	Settings can be returned to defaults as required.			
	Mutual interference prevention	Possible for up to 5 Units.* Intermittent oscillation method (Response time = (number of Units connected + 1) \times 15 ms)			
	Hysteresis setting	Setting range: 10 to 4,000			
	I/O settings	Output setting (Select from channel 2 output, area output, self-diagnosis, or open circuit detection.)		Input setting (Select from teaching, fine positioning, zero-reset, synchronous detection.)	
Digital display		Select from the following: Incident level + threshold, incident level percentage +threshold, incident light peak level + incident light bottom level (updated with output), long bar display, incident level + peak hold, incident level + channel			
Display orientation		Switching between normal/reversed display is possible.			
Ambient temperature		Operating: When connecting 1 to 2 Units: -10°C to 55°C , When connecting 3 to 5 Units: -10°C to 50°C , When connecting 6 to 16 Units: -10°C to 45°C When used in combination with an EDR6-F When connecting 3 to 4 Units: -10°C to 50°C , When connecting 5 to 8 Units: -10°C to 45°C , When connecting 9 to 16 Units: -10°C to 40°C Storage: -20 to 70°C (with no icing)			
Ambient humidity		Operating/storage: 35% to 85% (with no condensation)			
Insulation resistance		20 M Ω min. at 500 VDC			
Dielectric strength		1,000 VAC, 50/60 Hz for 1 min			
Vibration resistance		Destruction: 10 to 55 Hz, 1.5-mm double amplitude for 2 hours each in X, Y, and Z directions			
Shock resistance		Destruction: 500 m/s ² 3 times each in X, Y, and Z directions			
Degree of protection		IEC 60529 IP50			
Connection method		Pre-wired Models	Connector Models	Pre-wired Models	Connector Models
Weight (packed state)		Approx. 100 g	Approx. 55 g	Approx. 100 g	Approx. 55 g
Materials	Case	PBT			
	Cover	Polycarbonate			

* Communications are disabled if the super-high-speed sensing mode is selected, and the mutual interference prevention function and the communications functions for the Mobile Console will not function.

Proximity Sensors

Sensing Guide

Cylindrical Models

Rectangular Models

Separate Amp/Pre-wired Connector Models

Capacitive Models

Others

Peripheral Devices

General Information

E2EC

E2C-EDA

E2C

/E2C-H

E2CY

E2C-EDA

Engineering Data (Typical)

Sensing Distance vs. Display Values

E2C-EDR6-F

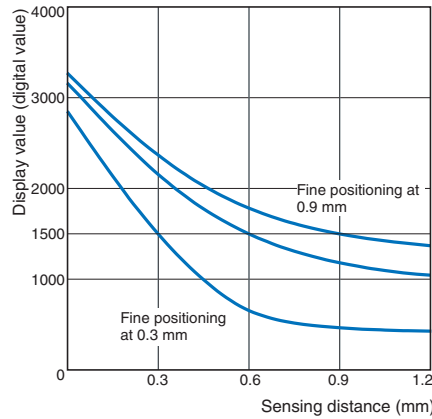

E2C-ED01(-□)

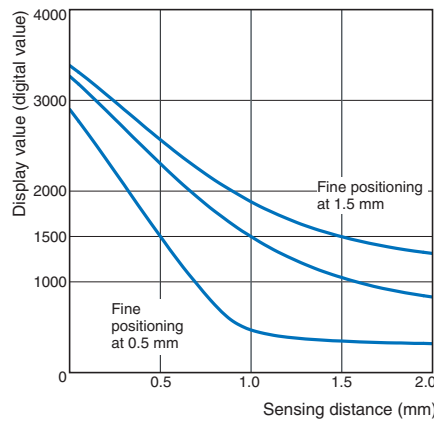

E2C-ED02(-□)/EM02(-□)

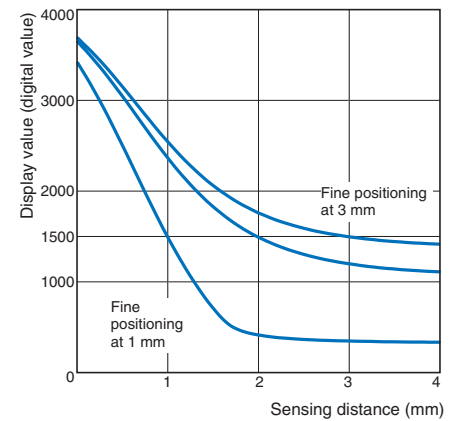

E2C-EM07M(-□)

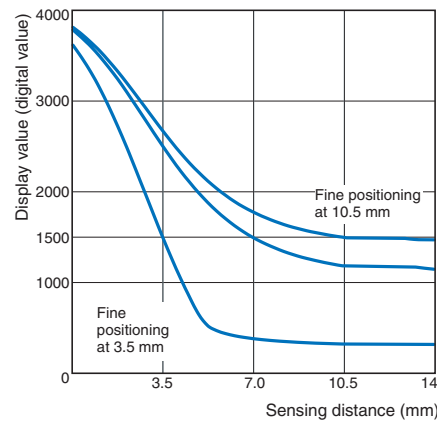

E2C-EV05(-□)

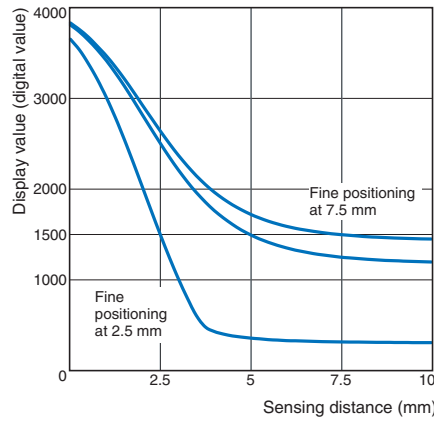

E2C-EM02H

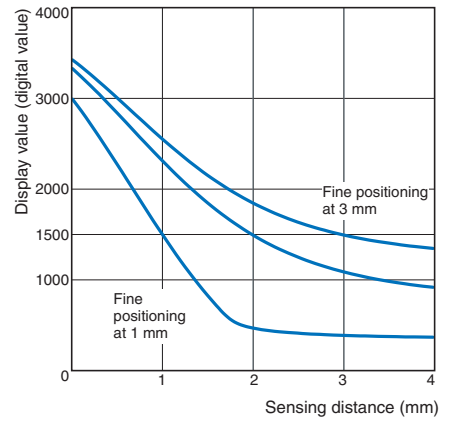

Proximity Sensors

Sensing Guide

Cylindrical Models

Rectangular Models

Separate Amp/Pre-wired Connector Models

Capacitive Models

Others

Influence of Sensing Object Size and Material

E2C-EDR6-F

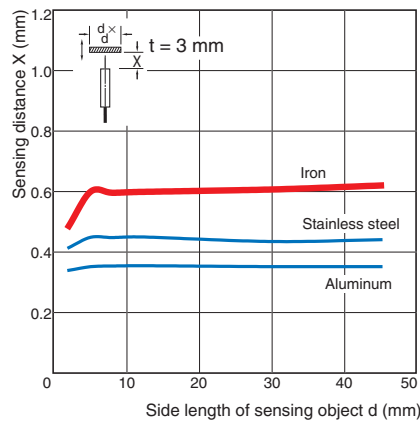

E2C-ED01(-□)

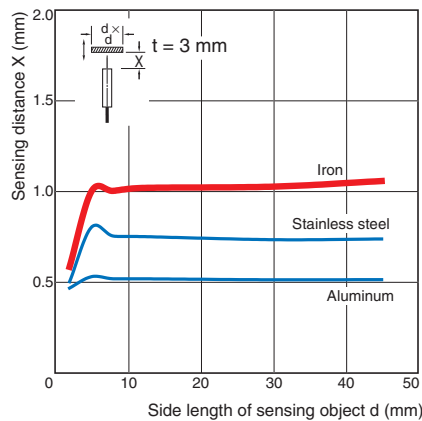

E2C-ED02(-□)/EM02(-□)

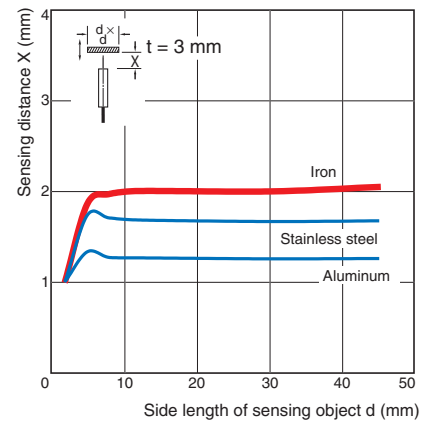

Peripheral Devices

General Information

E2EC

E2C-EDA

E2C

/E2C-H

E2CY

E2C-EM07M(-□)

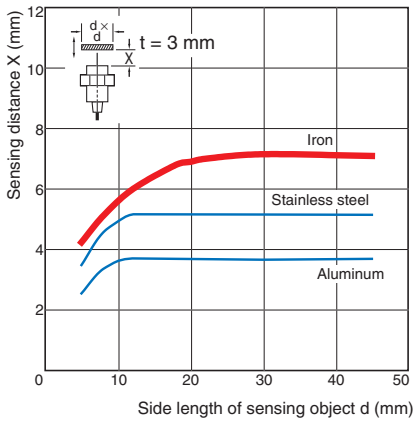

E2C-EV05(-□)

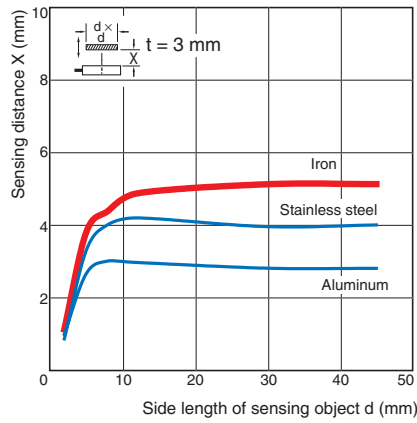

E2C-EM02H

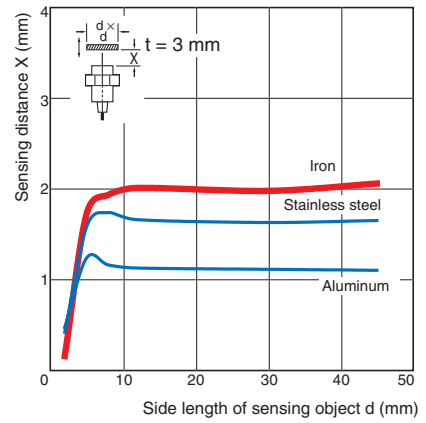

Influence of Sensor Head Temperature

E2C-EDR6-F

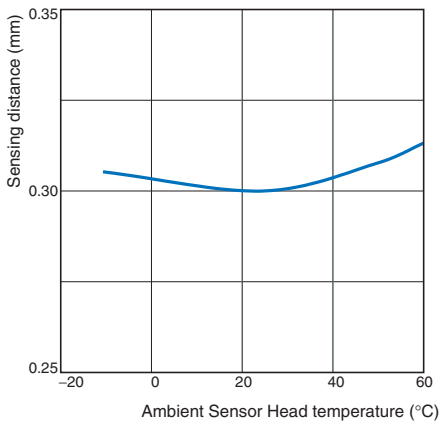

E2C-ED01(-□)

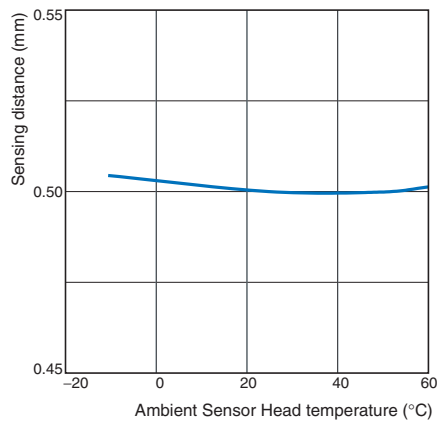

E2C-ED02(-□)/EM02(-□)

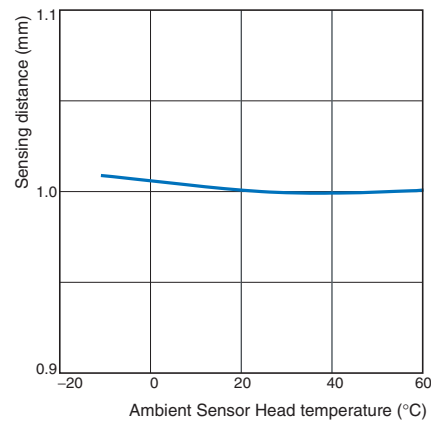

E2C-EM07M(-□)

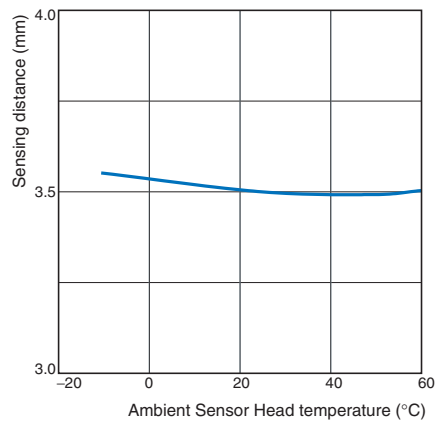

E2C-EV05(-□)

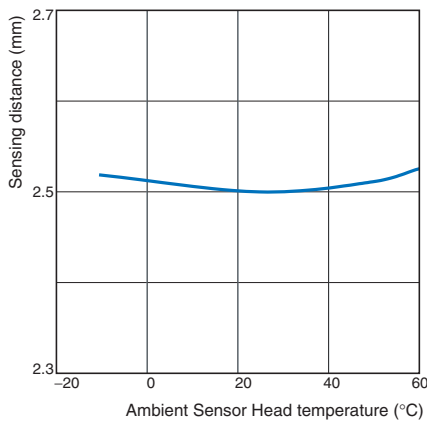

E2C-EM02H

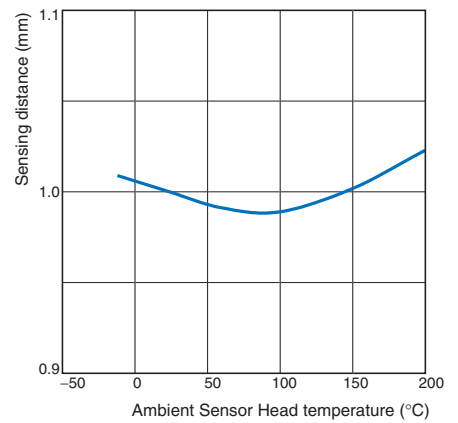

Proximity Sensors

Sensing Guide

Cylindrical Models

Rectangular Models

Separate Amp/Pre-wired Connector Models

Capacitive Models

Others

Peripheral Devices

General Information

E2C

E2C-EDA

E2C

/E2C-H

E2CY

E2C-EDA

I/O Circuit Diagrams

NPN output

Model	Operation mode	Timing Chart	Mode selector	Output circuit
E2C-EDA11 E2C-EDA6	NO (normally open)		NO	
	NC (normally closed)		NC	
E2C-EDA21 E2C-EDA7	NO (normally open)		NO	
	NC (normally closed)		NC	

Note: 1. Setting Areas for Twin-output Models
 Normally open: ON between the thresholds for Channel 1 and Channel 2
 Normally closed: OFF between the thresholds for Channel 1 and Channel 2
 2. Timing Charts for Timer Settings (T: Set Time)

	ON delay	OFF delay	One-shot
Sensing object Present			
Sensing object Not present			
NO			
NO			
NC			
NC			

Proximity Sensors

Sensing Guide

Cylindrical Models

Rectangular Models

Separate Amp/Pre-wired Connector Models

Capacitive Models

Others

Peripheral Devices

General Information

E2EC
 E2C-EDA
 E2C /E2C-H
 E2CY

PNP output

Model	Operation mode	Timing Chart	Mode selector	Output circuit
E2C-EDA41 E2C-EDA8	NO (normally open)		NO	
	NC (normally closed)		NC	
E2C-EDA51 E2C-EDA9	NO (normally open)		NO	
	NC (normally closed)		NC	

Proximity Sensors

Sensing Guide

Cylindrical Models

Rectangular Models

Separate Amp/Pre-wired Connector Models

Capacitive Models

Others

Peripheral Devices

General Information

Note: 1. Setting Areas for Twin-output Models

Normally open: ON between the thresholds for Channel 1 and Channel 2

Normally closed: OFF between the thresholds for Channel 1 and Channel 2

2. Timing Charts for Timer Settings (T: Set Time)

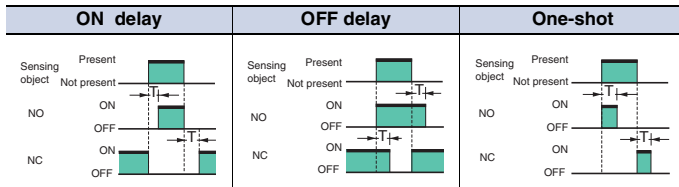

Nomenclature

Amplifier Units

Twin-output Models

(E2C-EDA11/EDA41/EDA6/EDA8)

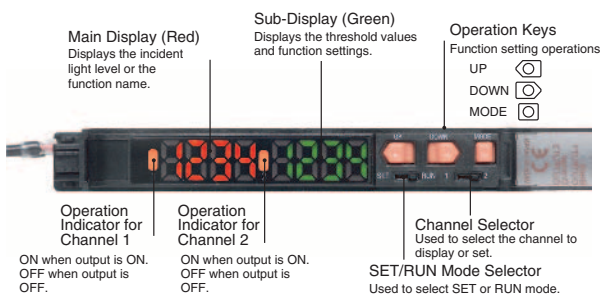

External-input Models

(E2C-EDA21/EDA51/EDA7/EDA9)

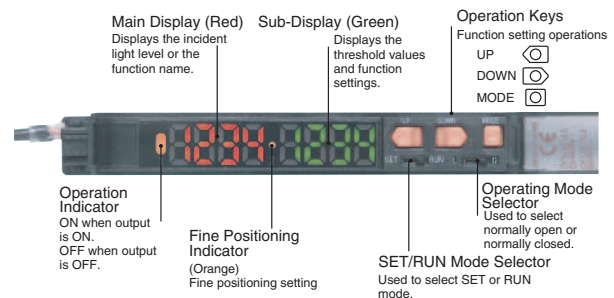

E2EC

E2C-EDA

E2C

/E2C-H

E2CY

E2C-EDA

Safety Precautions

Refer to *Warranty and Limitations of Liability* on page F-2.

⚠ WARNING

This product is not designed or rated for ensuring safety of persons. Do not use it for such purposes.



Precautions for Correct Use

Do not use the Encoder under ambient conditions that exceed the ratings.

Amplifier Units

● Design

Power ON

The Sensor is ready to sense an object within 200 ms after turning the power ON. If the load and Sensor are connected to different power supplies, always turn ON the Sensor power first.

● Mounting

Connecting and Disconnecting Sensor Heads

- (1) Open the protective cover.
- (2) Making sure that the lock button on the Sensor Head connector is up, insert the fibers all the way to the back of the connector insertion opening.

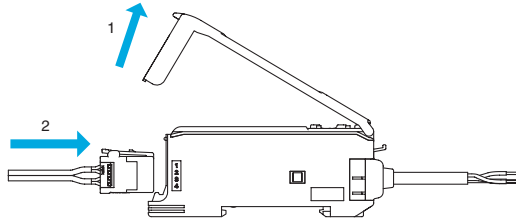

To disconnect the Sensor Head, pull out the fibers while pressing on the lock button.

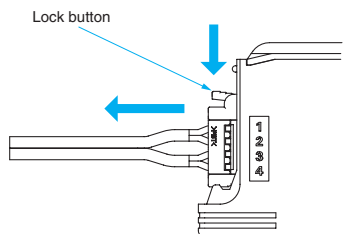

Connecting and Disconnecting Connectors

Connecting

- (1) Insert the Master or Slave Connector into the Amplifier Unit until it clicks into place.

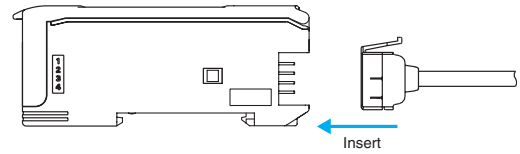

- (2) Apply the enclosed seal to the unconnected surface of the Master/Slave Connector.

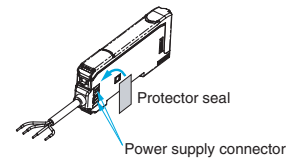

Note: Apply the seal to the grooved side.

Disconnecting

- (1) Slide the Slave Amplifier Unit.
- (2) After the Amplifier Unit has been separated, press down on the lever on the connector and remove the connector. (Do not attempt to remove the connector without separating it from the other Amplifier Unit first.)

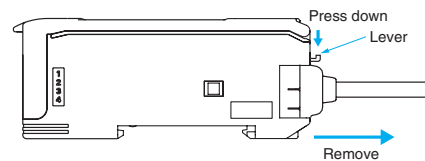

Installing and Removing Amplifier Units

Installing

- (1) Install the Units one by one on the DIN Track.

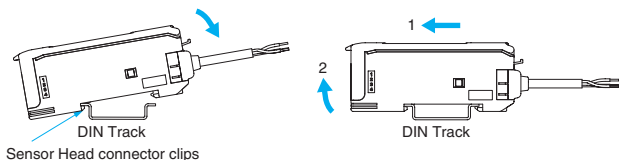

- (2) Slide one Unit toward the other, match the clips at the front ends, and then bring them together until they click into place.

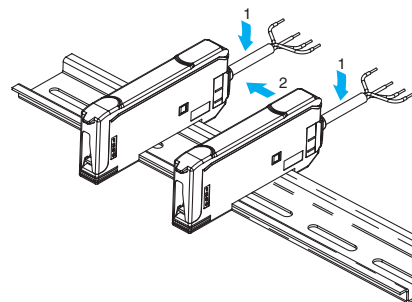

Removing

- Slide one Unit away from the other and remove them one by one. (Do not remove the connected Units together from the DIN Track.)

Note: 1. When the Amplifier Units are connected to each other, the operable ambient temperature changes depending on the number of connected Amplifier Units. Check *Ratings and Specifications* on page 853.
2. Before connecting or disconnecting the Units, always turn OFF the power.

Mounting End Plates (PFP-M)

Mount End Plates on Amplifier Units to avoid movement due to vibration. When a Mobile Console is installed, mount the End Plate facing as shown in the following diagram.

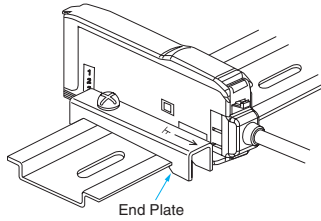

Mounting a Communications Head for the Mobile Console

Leave a space of at least 20 mm on the left side of the Units for a Mobile Console Communications Head.

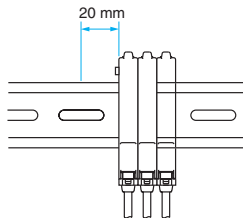

EEPROM Write Errors

If the data is not written to the EEPROM correctly due to a power interruption or static-electric noise, initialize the settings using the keys on the Amplifier Unit. "ERR/EEP" will flash on the display if an EEPROM write error occurs.

Optical Communications

When using more than one Amplifier Unit, mount the Units side-by-side. Do not slide or remove Units while they are in use.

Miscellaneous

Protective Cover

Be sure to attach the Protective Cover before using the Sensor.

Mobile Console

Use the E3X-MC11-SV2 Mobile Console with E2C-EDA-series Amplifier Units. Other Mobile Consoles, such as the E3X-MC11, cannot be used.

Sensor Head and Amplifier Unit Combinations

Be sure to use only specified Sensor Head and Amplifier Unit combinations. The E3C-LDA-series Photoelectric Sensors with Separate Digital Amplifiers are not compatible. The E2C-EDA must not be used with products from that series.

Warm-up

The digital display may slowly change until the circuits stabilize after the power is turned ON. It takes about 30 minutes after the power is turned ON before the E2C-EDA is ready to sense.

Maintenance Inspection

- Be sure to turn OFF the power before adjusting, connecting, or disconnecting the Sensor Head.
- Do not use thinner, benzene, acetone, or kerosene to clean the Sensor Head or Amplifier Unit.

Sensor Heads

Mounting

Mounting Sensor Heads

- Use the dimensions from the following table to mount Unthreaded Cylindrical Models (E2C-ED-□□). Do not tighten screws with torque exceeding 0.2 N·m when mounting Sensor Heads.

Model	Tightening range A
E2C-EDR6-F	9 to 18 mm
E2C-ED01□□	9 to 18 mm
E2C-ED02□□	11 to 12 mm

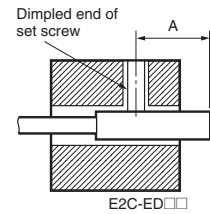

- Use the torque given in the following table to tighten Unthreaded Cylindrical Models (E2C-EM-□□).

Model	Tightening torque
E2C-EM02□□	15 N·m max.
E2C-EM07M□□	15 N·m max.
E2C-EM02H□□	5.9 N·m max.

- Do not use torque exceeding 0.5 N·m to tighten screws when mounting Flat Models (E2C-EV□□).
- Use a bending radius of 8 mm or greater for the Sensor Head cable.
- Use only the special Extension Cable to extend the cable between the Sensor Head and the Amplifier Unit. Consult your OMRON representative for details.

Influence of Surrounding Metal

- Provide a minimum distance between the Sensor and the surrounding metal as shown in the table below.

Influence of Surrounding Metal (Unit: mm)

Model	Counterbore A	Protrusion B
E2C-EDR6-F	3.1	0
E2C-ED01□□	5.4	0
E2C-ED02□□	8	0
E2C-EM02□□	10	0
E2C-EM07M□□	35	20
E2C-EV05□□	14 × 30	4.8
E2C-EM02H□□	12	0

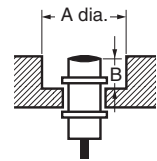

Mutual Interference

- When installing Sensors face-to-face or side-by-side, ensure that the minimum distances given in the following table are maintained.
- The distance between Sensor Heads may be narrower than specified with these Sensors because the Mutual Interference Prevention Function is used for optical communications between the Amplifier Units.

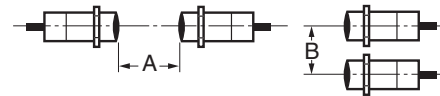

Mutual Interference

(Unit: mm)

Model	Face-to-face (arrangement A)	Side-by-side (arrangement B)	Face-to-face using the Mutual Interference Prevention Function (arrangement A')	Side-by-side using the Mutual Interference Prevention Function (arrangement B')
E2C-EDR6-F	14	10	3.5	3.1
E2C-ED01□□	45	20	9	5.4
E2C-ED02□□	35	30	21	8
E2C-EM02□□	35	30	21	10
E2C-EM07M□□	140	120	35	18
E2C-EV05□□	65	30	21	14
E2C-EM02H□□	45	30	21	12

Proximity Sensors

Sensing Guide

Cylindrical Models

Rectangular Models

Separate Amp/Pre-wired Connector Models

Capacitive Models

Others

Peripheral Devices

General Information

E2EC

E2C-EDA

E2C

/E2C-H

E2CY

E2C-EDA

Dimensions

(Unit: mm)

Sensor

E2C-EDR6-F

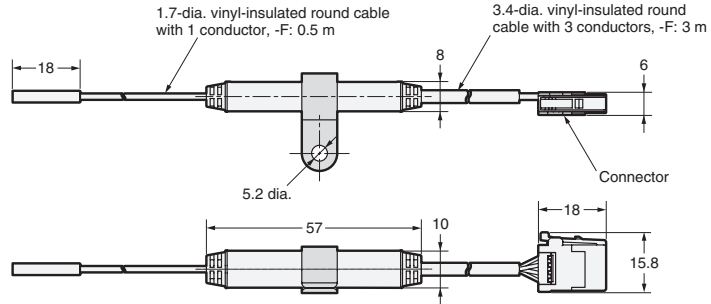

CAD data

E2C-ED01(-F)

Proximity Sensors

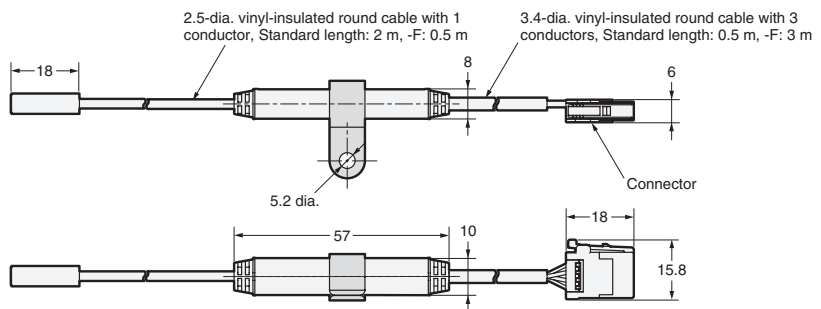

CAD data

E2C-ED02(-F)

Sensing Guide

Cylindrical Models

Rectangular Models

Separate Amp/Pre-wired Connector Models

Capacitive Models

Others

Peripheral Devices

General Information

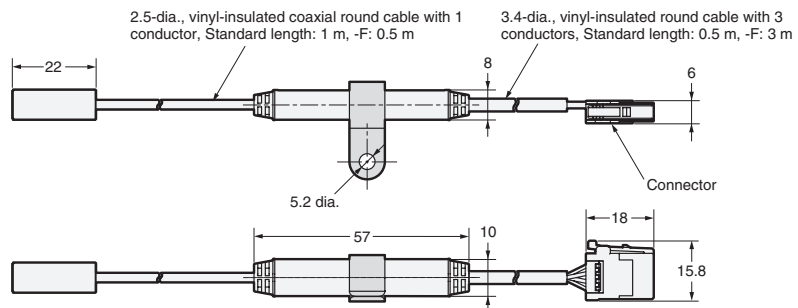

CAD data

E2C-EM02(-F)

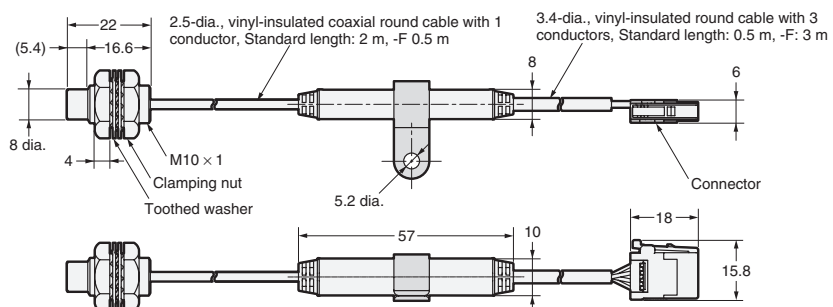

CAD data

E2C-EM07M(-F)

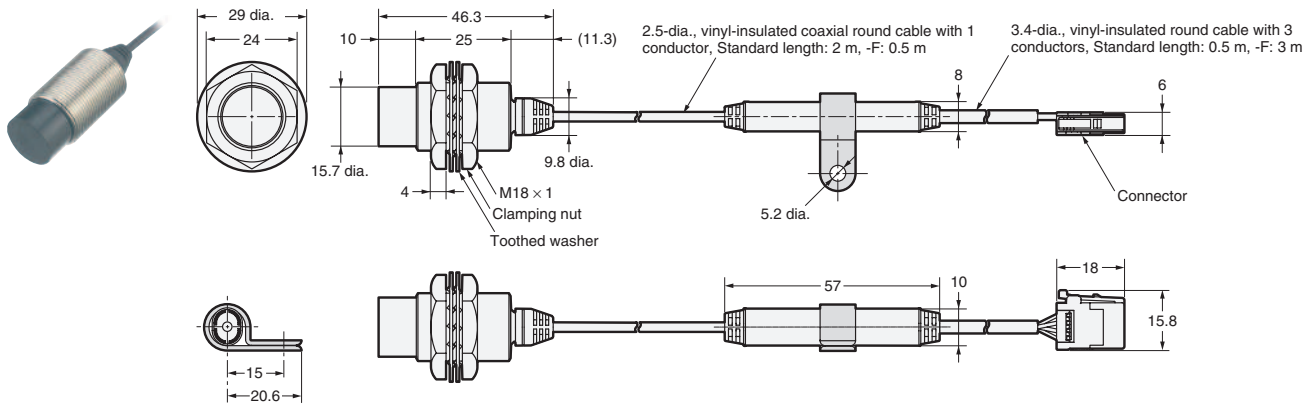

CAD data

Proximity Sensors

E2C-EV05(-F)

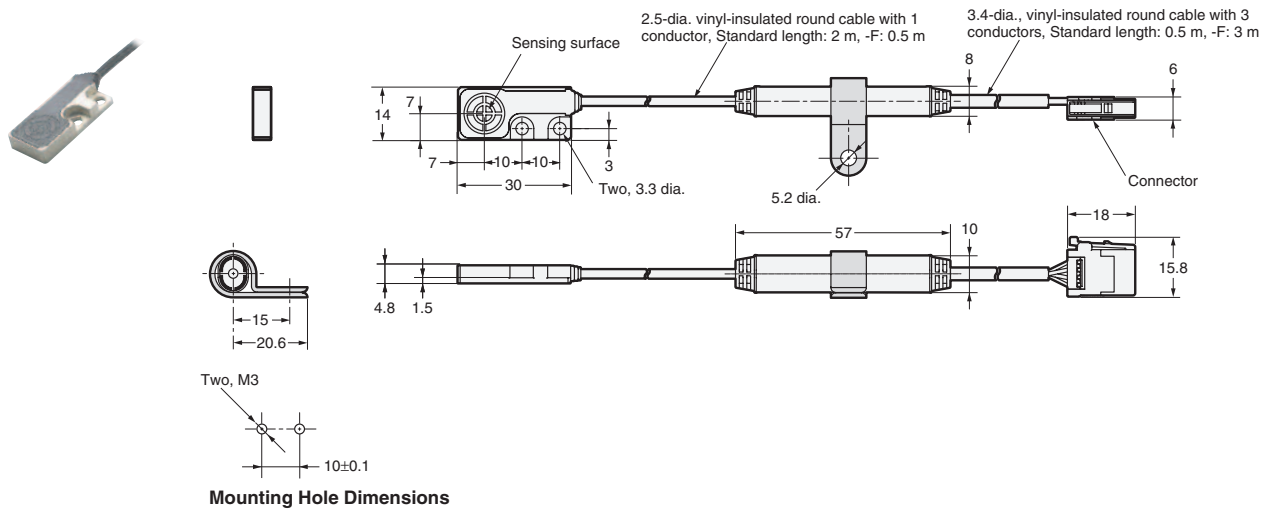

CAD data

Sensing Guide

Cylindrical Models

Rectangular Models

Separate Amp/ Pre-wired Connector Models

Capacitive Models

Others

E2C-EM02H

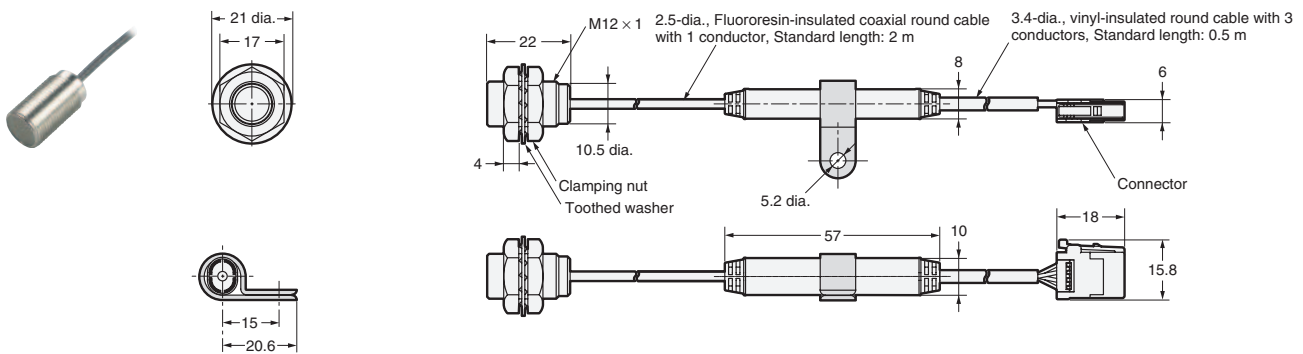

CAD data

Peripheral Devices

General Information

E2EC

E2C-EDA

E2C

/E2C-H

E2CY

Amplifier Unit

Pre-wired Models

E2C-EDA11
E2C-EDA21
E2C-EDA41
E2C-EDA51

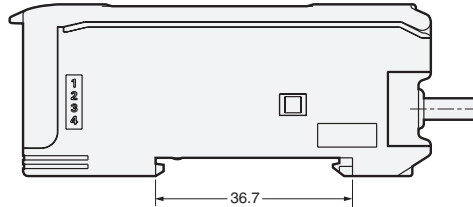
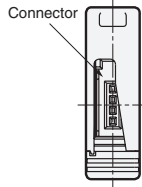
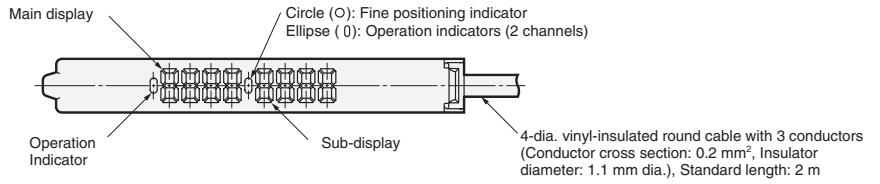

With Mounting Bracket Attached

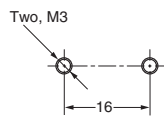
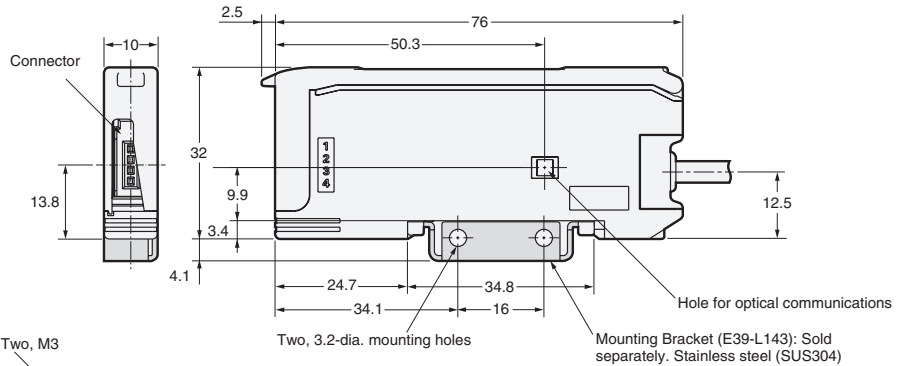
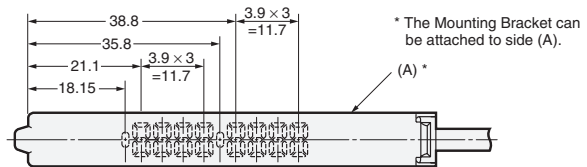

Mounting Hole Dimensions

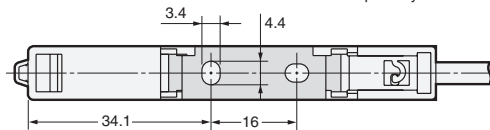

CAD data

Proximity Sensors

Sensing Guide

Cylindrical Models

Rectangular Models

Separate Amp/Pre-wired Connector Models

Capacitive Models

Others

Peripheral Devices

General Information

E2EC

E2C-EDA

E2C

/E2C-H

E2CY

Connector Models

- E2C-EDA6
- E2C-EDA7
- E2C-EDA8
- E2C-EDA9

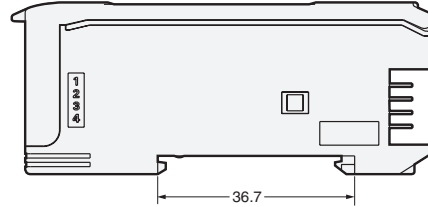
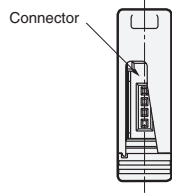
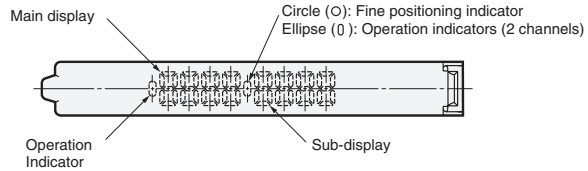

With Mounting Bracket Attached

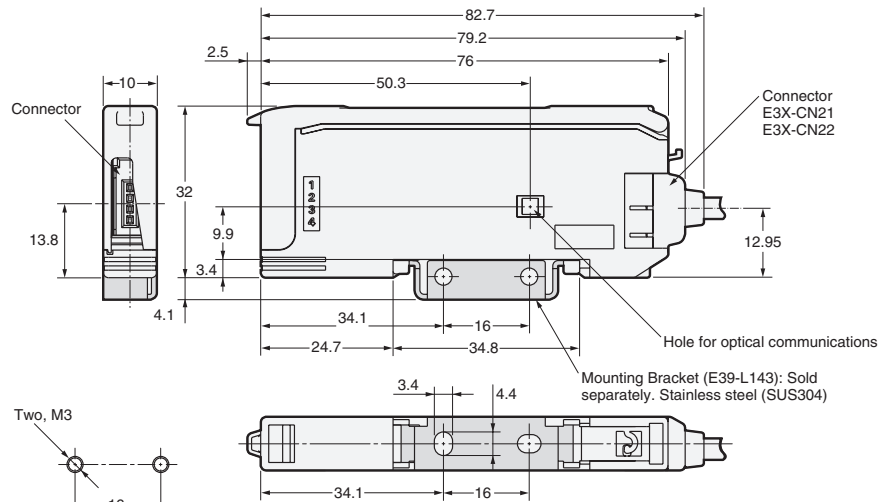
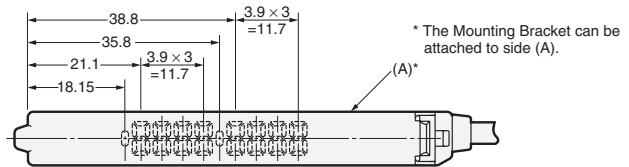

Mounting Hole Dimensions

CAD data

Amplifier Unit Connectors

Refer to page 81 for details.

Mobile Console

Refer to page 81 for details.

Accessories (Order Separately)

Mounting Bracket

Refer to page 292 for details.

End Plate

Refer to page 1232 for details.

Cat. No. D814-E1-01

In the interest of product improvement, specifications are subject to change without notice.

Proximity Sensors

Sensing Guide

Cylindrical Models

Rectangular Models

Separate Amp/Pre-wired Connector Models

Capacitive Models

Others

Peripheral Devices

General Information

E2EC

E2C-EDA

E2C

/E2C-H

E2CY

Terms and Conditions of Sale

- Offer; Acceptance.** These terms and conditions (these "Terms") are deemed part of all quotes, agreements, purchase orders, acknowledgments, price lists, catalogs, manuals, brochures and other documents, whether electronic or in writing, relating to the sale of products or services (collectively, the "Products") by Omron Electronics LLC and its subsidiary companies ("Omron"). Omron objects to any terms or conditions proposed in Buyer's purchase order or other documents which are inconsistent with, or in addition to, these Terms.
- Prices; Payment Terms.** All prices stated are current, subject to change without notice by Omron. Omron reserves the right to increase or decrease prices on any unshipped portions of outstanding orders. Payments for Products are due net 30 days unless otherwise stated in the invoice.
- Discounts.** Cash discounts, if any, will apply only on the net amount of invoices sent to Buyer after deducting transportation charges, taxes and duties, and will be allowed only if (i) the invoice is paid according to Omron's payment terms and (ii) Buyer has no past due amounts.
- Interest.** Omron, at its option, may charge Buyer 1-1/2% interest per month or the maximum legal rate, whichever is less, on any balance not paid within the stated terms.
- Orders.** Omron will accept no order less than \$200 net billing.
- Governmental Approvals.** Buyer shall be responsible for, and shall bear all costs involved in, obtaining any government approvals required for the importation or sale of the Products.
- Taxes.** All taxes, duties and other governmental charges (other than general real property and income taxes), including any interest or penalties thereon, imposed directly or indirectly on Omron or required to be collected directly or indirectly by Omron for the manufacture, production, sale, delivery, importation, consumption or use of the Products sold hereunder (including customs duties and sales, excise, use, turnover and license taxes) shall be charged to and remitted by Buyer to Omron.
- Financial.** If the financial position of Buyer at any time becomes unsatisfactory to Omron, Omron reserves the right to stop shipments or require satisfactory security or payment in advance. If Buyer fails to make payment or otherwise comply with these Terms or any related agreement, Omron may (without liability and in addition to other remedies) cancel any unshipped portion of Products sold hereunder and stop any Products in transit until Buyer pays all amounts, including amounts payable hereunder, whether or not then due, which are owing to it by Buyer. Buyer shall in any event remain liable for all unpaid accounts.
- Cancellation; Etc.** Orders are not subject to rescheduling or cancellation unless Buyer indemnifies Omron against all related costs or expenses.
- Force Majeure.** Omron shall not be liable for any delay or failure in delivery resulting from causes beyond its control, including earthquakes, fires, floods, strikes or other labor disputes, shortage of labor or materials, accidents to machinery, acts of sabotage, riots, delay in or lack of transportation or the requirements of any government authority.
- Shipping; Delivery.** Unless otherwise expressly agreed in writing by Omron:
 - Shipments shall be by a carrier selected by Omron; Omron will not drop ship except in "break down" situations.
 - Such carrier shall act as the agent of Buyer and delivery to such carrier shall constitute delivery to Buyer;
 - All sales and shipments of Products shall be FOB shipping point (unless otherwise stated in writing by Omron), at which point title and risk of loss shall pass from Omron to Buyer; provided that Omron shall retain a security interest in the Products until the full purchase price is paid;
 - Delivery and shipping dates are estimates only; and
 - Omron will package Products as it deems proper for protection against normal handling and extra charges apply to special conditions.
- Claims.** Any claim by Buyer against Omron for shortage or damage to the Products occurring before delivery to the carrier must be presented in writing to Omron within 30 days of receipt of shipment and include the original transportation bill signed by the carrier noting that the carrier received the Products from Omron in the condition claimed.
- Warranties.** (a) **Exclusive Warranty.** Omron's exclusive warranty is that the Products will be free from defects in materials and workmanship for a period of twelve months from the date of sale by Omron (or such other period expressed in writing by Omron). Omron disclaims all other warranties, express or implied. (b) **Limitations.** OMRON MAKES NO WARRANTY OR REPRESENTATION, EXPRESS OR IMPLIED, ABOUT NON-INFRINGEMENT, MERCHANTABILITY OR FITNESS FOR A PARTICULAR PURPOSE OF THE PRODUCTS. BUYER ACKNOWLEDGES THAT IT ALONE HAS DETERMINED THAT THE PRODUCTS WILL SUITABLY MEET THE REQUIREMENTS OF THEIR INTENDED USE. Omron further disclaims all warranties and responsibility of any type for claims or expenses based on infringement by the Products or otherwise of any intellectual property right. (c) **Buyer Remedy.** Omron's sole obligation hereunder shall be, at Omron's election, to (i) replace (in the form originally shipped with Buyer responsible for labor charges for removal or replacement thereof) the non-complying Product, (ii) repair the non-complying Product, or (iii) repay or credit Buyer an amount equal to the purchase price of the non-complying Product; provided that in no event shall Omron be responsible for warranty, repair, indemnity or any other claims or expenses regarding the Products unless Omron's analysis confirms that the Products were properly handled, stored, installed and maintained and not subject to contamination, abuse, misuse or inappropriate modification. Return of any Products by Buyer must be approved in writing by Omron before shipment. Omron Companies shall not be liable for the suitability or unsuitability or the results from the use of Products in combination with any electrical or electronic components, circuits, system assemblies or any other materials or substances or environments. Any advice, recommendations or information given orally or in writing, are not to be construed as an amendment or addition to the above warranty. See <http://oeweb.omron.com> or contact your Omron representative for published information.
- Limitation on Liability; Etc.** OMRON COMPANIES SHALL NOT BE LIABLE FOR SPECIAL, INDIRECT, INCIDENTAL, OR CONSEQUENTIAL DAMAGES, LOSS OF PROFITS OR PRODUCTION OR COMMERCIAL LOSS IN ANY WAY CONNECTED WITH THE PRODUCTS, WHETHER SUCH CLAIM IS BASED IN CONTRACT, WARRANTY, NEGLIGENCE OR STRICT LIABILITY. Further, in no event shall liability of Omron Companies exceed the individual price of the Product on which liability is asserted.
- Indemnities.** Buyer shall indemnify and hold harmless Omron Companies and their employees from and against all liabilities, losses, claims, costs and expenses (including attorney's fees and expenses) related to any claim, investigation, litigation or proceeding (whether or not Omron is a party) which arises or is alleged to arise from Buyer's acts or omissions under these Terms or in any way with respect to the Products. Without limiting the foregoing, Buyer (at its own expense) shall indemnify and hold harmless Omron and defend or settle any action brought against such Companies to the extent based on a claim that any Product made to Buyer specifications infringed intellectual property rights of another party.
- Property; Confidentiality.** Any intellectual property in the Products is the exclusive property of Omron Companies and Buyer shall not attempt to duplicate it in any way without the written permission of Omron. Notwithstanding any charges to Buyer for engineering or tooling, all engineering and tooling shall remain the exclusive property of Omron. All information and materials supplied by Omron to Buyer relating to the Products are confidential and proprietary, and Buyer shall limit distribution thereof to its trusted employees and strictly prevent disclosure to any third party.
- Export Controls.** Buyer shall comply with all applicable laws, regulations and licenses regarding (i) export of products or information; (ii) sale of products to "forbidden" or other proscribed persons; and (iii) disclosure to non-citizens of regulated technology or information.
- Miscellaneous.** (a) **Waiver.** No failure or delay by Omron in exercising any right and no course of dealing between Buyer and Omron shall operate as a waiver of rights by Omron. (b) **Assignment.** Buyer may not assign its rights hereunder without Omron's written consent. (c) **Law.** These Terms are governed by the law of the jurisdiction of the home office of the Omron company from which Buyer is purchasing the Products (without regard to conflict of law principles). (d) **Amendment.** These Terms constitute the entire agreement between Buyer and Omron relating to the Products, and no provision may be changed or waived unless in writing signed by the parties. (e) **Severability.** If any provision hereof is rendered ineffective or invalid, such provision shall not invalidate any other provision. (f) **Setoff.** Buyer shall have no right to set off any amounts against the amount owing in respect of this invoice. (g) **Definitions.** As used herein, "including" means "including without limitation"; and "Omron Companies" (or similar words) mean Omron Corporation and any direct or indirect subsidiary or affiliate thereof.

Certain Precautions on Specifications and Use

- Suitability of Use.** Omron Companies shall not be responsible for conformity with any standards, codes or regulations which apply to the combination of the Product in the Buyer's application or use of the Product. At Buyer's request, Omron will provide applicable third party certification documents identifying ratings and limitations of use which apply to the Product. This information by itself is not sufficient for a complete determination of the suitability of the Product in combination with the end product, machine, system, or other application or use. Buyer shall be solely responsible for determining appropriateness of the particular Product with respect to Buyer's application, product or system. Buyer shall take application responsibility in all cases but the following is a non-exhaustive list of applications for which particular attention must be given:
 - Outdoor use, uses involving potential chemical contamination or electrical interference, or conditions or uses not described in this document.
 - Use in consumer products or any use in significant quantities.
 - Energy control systems, combustion systems, railroad systems, aviation systems, medical equipment, amusement machines, vehicles, safety equipment, and installations subject to separate industry or government regulations.
 - Systems, machines and equipment that could present a risk to life or property. Please know and observe all prohibitions of use applicable to this Product.

NEVER USE THE PRODUCT FOR AN APPLICATION INVOLVING SERIOUS RISK TO LIFE OR PROPERTY OR IN LARGE QUANTITIES WITHOUT ENSURING THAT THE SYSTEM AS A WHOLE HAS BEEN DESIGNED TO ADDRESS THE RISKS, AND THAT THE OMRON'S PRODUCT IS PROPERLY RATED AND INSTALLED FOR THE INTENDED USE WITHIN THE OVERALL EQUIPMENT OR SYSTEM.
- Programmable Products.** Omron Companies shall not be responsible for the user's programming of a programmable Product, or any consequence thereof.
- Performance Data.** Data presented in Omron Company websites, catalogs and other materials is provided as a guide for the user in determining suitability and does not constitute a warranty. It may represent the result of Omron's test conditions, and the user must correlate it to actual application requirements. Actual performance is subject to the Omron's Warranty and Limitations of Liability.
- Change in Specifications.** Product specifications and accessories may be changed at any time based on improvements and other reasons. It is our practice to change part numbers when published ratings or features are changed, or when significant construction changes are made. However, some specifications of the Product may be changed without any notice. When in doubt, special part numbers may be assigned to fix or establish key specifications for your application. Please consult with your Omron's representative at any time to confirm actual specifications of purchased Product.
- Errors and Omissions.** Information presented by Omron Companies has been checked and is believed to be accurate; however, no responsibility is assumed for clerical, typographical or proofreading errors or omissions.

Complete "Terms and Conditions of Sale" for product purchase and use are on Omron's website at www.omron.com/oei – under the "About Us" tab, in the Legal Matters section.

ALL DIMENSIONS SHOWN ARE IN MILLIMETERS.

To convert millimeters into inches, multiply by 0.03937. To convert grams into ounces, multiply by 0.03527.

OMRON[®]**OMRON ELECTRONICS LLC**

One Commerce Drive
Schaumburg, IL 60173

847-843-7900

For US technical support or other inquiries:

800-556-6766**OMRON CANADA, INC.**

885 Milner Avenue
Toronto, Ontario M1B 5V8

416-286-6465**OMRON ON-LINE**

Global - <http://www.omron.com>
USA - <http://www.omron.com/oei>
Canada - <http://www.omron.ca>