

SEBAT54/A/C/S
Schottky barrier diode

Revision:B

Features

- Low Turn-on Voltage
- Fast Switching
- PN Junction Guard Ring for Transient and ESD Protection

Applications

- Rectifying small power

Construction

- Silicon epitaxial planer

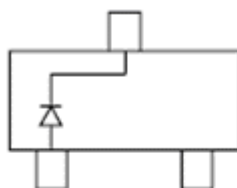

SEBAT54

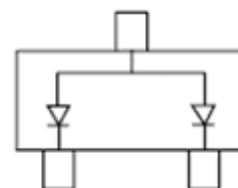

SEBAT54A

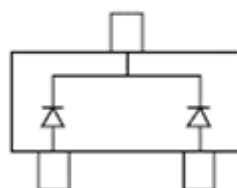

SEBAT54C

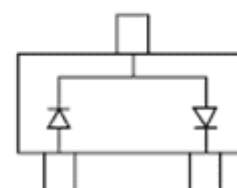

SEBAT54S

SOT-23

Absolute maximum ratings (Ta=25°C)

Parameter	Symbol	Limits	Unit
Reverse voltage (repetitive peak)	V_{RM}	30	V
Reverse voltage (DC)	V_R	30	V
Repetitive Peak Forward Current	I_{FRM}	300	mA
Forward current surge peak	I_{FSM}	600	mA
Junction temperature	T_j	125	°C
Storage temperature	T_{stg}	-65 ~ +125	°C

Electrical characteristics (Ta=25°C)

Parameter	Symbol	Min.	Typ.	Max.	Unit	Conditions
Forward voltage	V_F	—	—	240	mV	$I_F = 0.1mA$
	V_F	—	—	320	mV	$I_F = 1mA$
	V_F	—	—	400	mV	$I_F = 10mA$
	V_F	—	—	500	mV	$I_F = 30mA$
	V_F	—	—	1000	mV	$I_F = 100mA$
Reverse current	I_R	—	—	2.0	uA	$V_R = 25V$

● Electrical characteristic curves

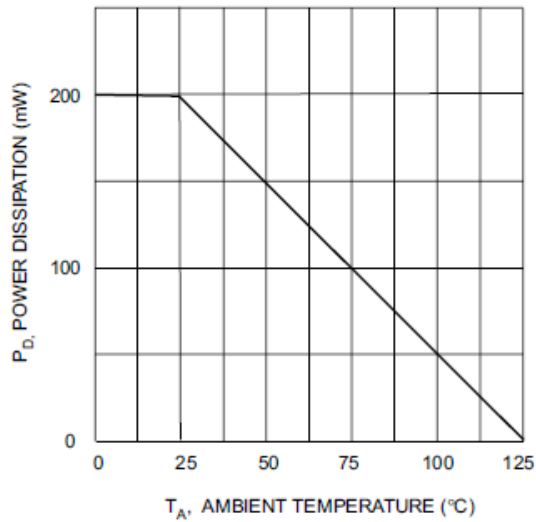

Fig. 1 Power Derating Curve

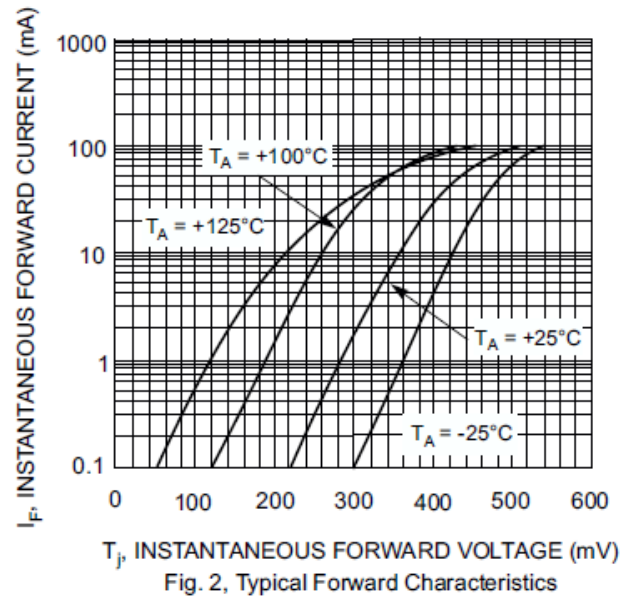

Fig. 2, Typical Forward Characteristics

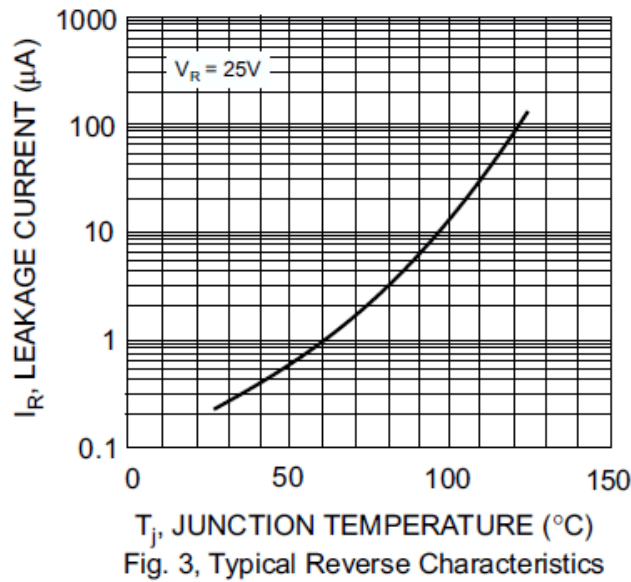
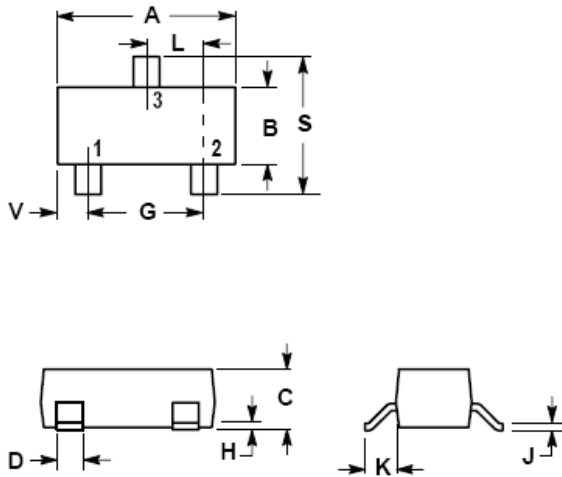

Fig. 3, Typical Reverse Characteristics

SOT-23



NOTES:

1. DIMENSIONING AND TOLERANCING PER ANSI Y14.5M,1982
2. CONTROLLING DIMENSION: INCH.

DIM	INCHES		MILLIMETERS	
	MIN	MAX	MIN	MAX
A	0.1102	0.1197	2.80	3.04
B	0.0472	0.0551	1.20	1.40
C	0.0350	0.0440	0.89	1.11
D	0.0150	0.0200	0.37	0.50
G	0.0701	0.0807	1.78	2.04
H	0.0005	0.0040	0.013	0.100
J	0.0034	0.0070	0.085	0.177
K	0.0140	0.0285	0.35	0.69
L	0.0350	0.0401	0.89	1.02
S	0.0830	0.1039	2.10	2.64
V	0.0177	0.0236	0.45	0.60

The SINO-IC logo is a registered trademark of ShangHai Sino-IC Microelectronics Co., Ltd.

© 2005 SINO-IC – Printed in China – All rights reserved.

SHANGHAI SINO-IC MICROELECTRONICS CO., LTD

Add: Building 3, Room 3401-03, No.200 Zhangheng Road, ZhangJiang Hi-Tech Park, Pudong, Shanghai 201203, China

Phone: +86-21-33932402 33932403 33932405 33933508 33933608

Fax: +86-21-33932401

Email: szrxw002@126.com

Website: <http://www.sino-ic.net>