

RoHS

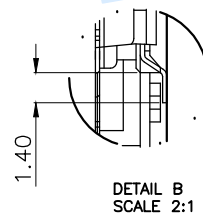
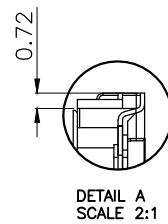
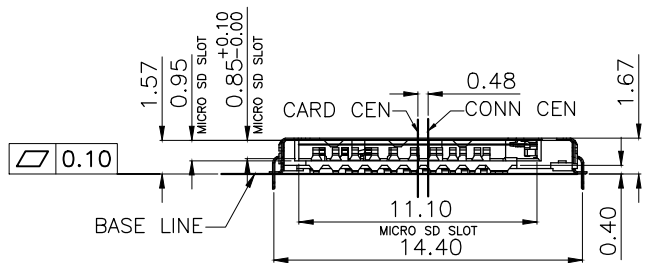
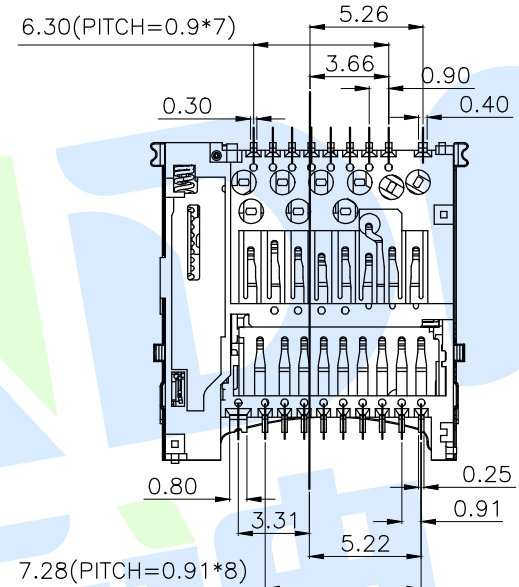
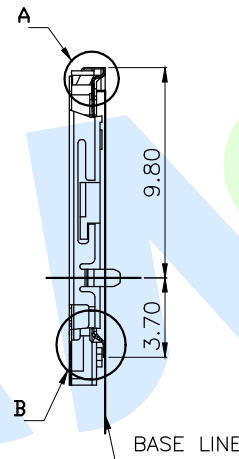
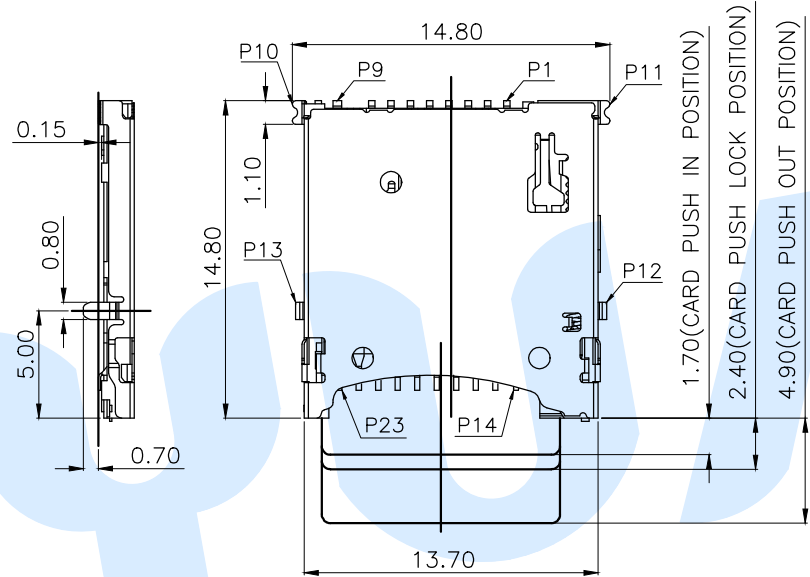
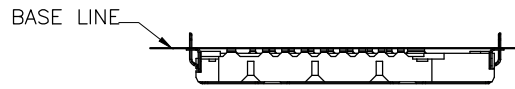

①	Spring		1	SUS	Nature
②	Terminal		18	Phosphor bronze	Ag Plated
③	Cover		1	SUS	Ni Plated
④	Base		1	LCP	Black
NO.	Name	Number	Qty	Materil	Remarks

YUANDI® Yuandi Electronics Co, Ltd

design	date	name	TF CARD CONNECTOR
Review	date	model	TF-43
Approved	date		

Drawing number: Proportion 1:1 unit mm gage number A4

modify Review Approved Tolerance not specified

angle	±2'
10~30	±0.30
5~10	±0.20
~ 5	±0.10

RoHS

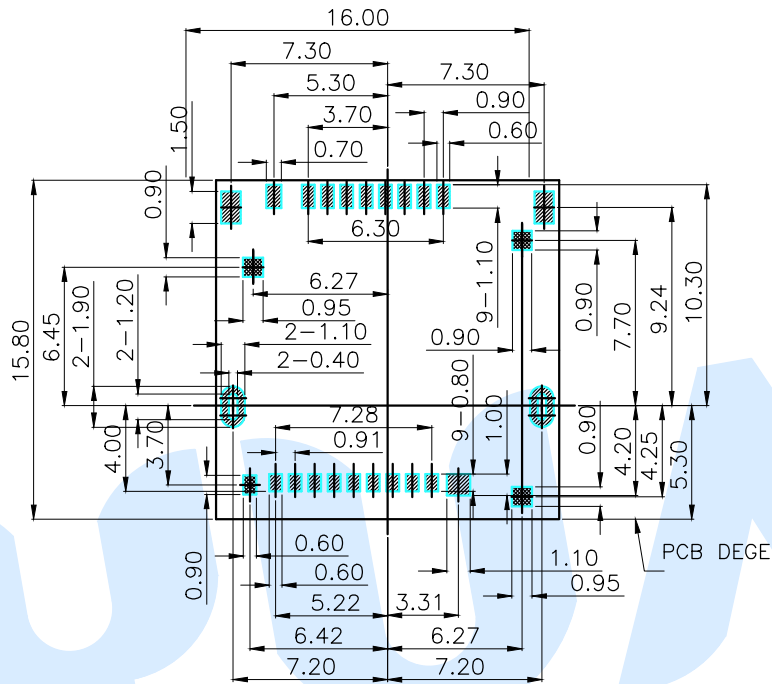

RECOMMENDED P.C.B LAYOUT
TOP VIEW(TOLERANCE+/-0.05)

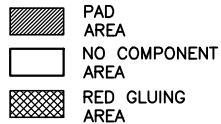

OPENING/CLOSE OF SWITCH

OPENING/CLOSE OF SWITCH	CARD DETECT SWITCH
CARD UNINSERTION	OPEN
CARD HALF INERTION	OPEN
CARD INSERTION	CLOSE

N/O	OPEN	CLOSE

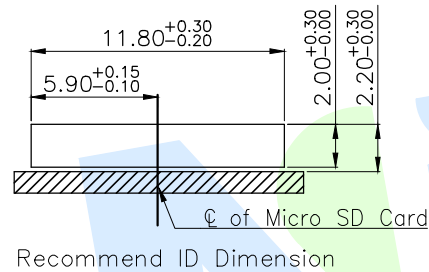

Pin No.	Pin Assignment
P1	Micro SD DAT2
P2	Micro SD CD/DAT3
P3	Micro SD CMD
P4	Micro SD VDD1
P5	Micro SD CLK
P6	Micro SD VSS
P7	Micro SD DAT0/RCLK+
P8	Micro SD DAT1/RCLK-
P9	Micro SD CD
P10	GND
P11	GND
P12	GND
P13	GND
P14	GND
P15	Micro SD VDD2
P16	Micro SD SWIO
P17	Micro SD VSS
P18	Micro SD D0+
P19	Micro SD D0-
P20	Micro SD VSS
P21	Micro SD D1-
P22	Micro SD D1+
P23	Micro SD VSS

angle	±2'	design	date	name	TF CARD CONNECTOR
10~30	±0.30	Review	date	model	TF-43
5~10	±0.20	Approved	date		
~ 5	±0.10	Drawing number:			
modify	Review	Approved	Tolerance not specified	Proportion	1:1
				unit	mm
				gape number	
					A4