

# Features

- Wide range input: 85-264VAC
- 130W peak power
- OVC III rating
- 2MOPP medical certified, B and BF ready
- 4000m operating altitude
- Class B EMC filter built-in

# Regulated Converter



# RACM130E-K

**130 Watt  
Open Frame  
2"x4" or  
Enclosed**



## Description

The RACM130E-K AC/DC power supply series provides up to 130W output to drive dynamic loads and is certified to safety standards for the medical, ITE, industrial and household markets. With an industry-standard 2"x4" footprint, variants are available as an open card or with an enclosure. Input is wide-range for nominals from 100 to 240Vac, the output is tightly regulated and easy system integration is enabled by a wide compliance margin to EMC standard EN55032 class B. On-board dual fuses are included and the product includes immunity to surges for installation Class 3 and Over-Voltage Category OVCIII. Certifications are maintained to 4000m altitude and with a wide operating temperature range, the series is one of the most versatile on the market.

## Selection Guide

Part Number	Input Voltage Range [VAC]	nom. Output Voltage [VDC]	Output Current <sup>(1)</sup> [A]	Output Power [W]	Efficiency typ. <sup>(2)</sup> [%]
RACM130E-12SK <sup>(2)</sup>	85-264	12	10.8	130	86
RACM130E-15SK <sup>(2)</sup>	85-264	15	8.66	130	88
RACM130E-24SK <sup>(2)</sup>	85-264	24	5.42	130	88
RACM130E-36SK <sup>(2)</sup>	85-264	36	3.61	130	88
RACM130E-48SK <sup>(2)</sup>	85-264	48	2.71	130	88

### Notes:

- Note1: Refer to **"Thermal Derating for externally provided forced air"**  
 Note2: Efficiency is tested at nominal input and full load at +25°C ambient

## Model Numbering



### Notes:

- Note3: "/OF" = standard open frame version  
 "/ENC" = standard enclosed version

### Ordering Examples:

RACM130E-12SK/OF	12Vout	Single	open frame	2" x 4"
RACM130E-15SK/ENC	15Vout	Single	enclosed	2.4" x 4.6"



ANSI/AAMI ES60601-1 Ed. 3.1 certified  
 CSA/CAN-C22.2 No. 60601-1:14 certified  
 IEC/EN60601-1 certified  
 IEC/EN62368-1 (pending)  
 IEC/EN60335-1 (pending)  
 IEC/EN61558-2-16 (pending)  
 IEC/EN61558-1 (pending)  
 EN55032 compliant  
 EN55035 compliant

**Specifications** (measured @ Ta= 25°C, nom. Vin, 130W @1m/s airflow and after warm-up unless otherwise stated)

**BASIC CHARACTERISTICS**

Parameter	Condition	Min.	Typ.	Max.
Nom. Input Voltage	50/60Hz	100VAC		240VAC
Operating Range <sup>(4,5)</sup>	47-63Hz	85VAC		264VAC
	DC	120VDC		370VDC
Input Current	115VAC			2.5A
	230VAC			1.5A
Inrush Current	cold start	115VAC		30A
		230VAC		60A
No load Power Consumption	@230VAC		200mW	
ErP Standby Mode Conformity (Output Load Capability)	115/230VAC	P <sub>IN</sub> = 0.5W	0.2W	
		P <sub>IN</sub> = 1W	0.6W	
Input Frequency Range	AC Input	47Hz		63Hz
Minimum Load		0%		
Power Factor	115VAC		0.5	
	230VAC		0.4	
Start-up Time			200ms	
Rise Time			20ms	
Hold-up Time	115VAC		16ms	
	230VAC		70ms	
Internal Operating Frequency	100% load at nominal Vin		65kHz	
Output Ripple and Noise <sup>(6)</sup>	20MHz BW			1% of Vout

**Notes:**

- Note4: The products were submitted for safety files at AC-Input operation
- Note5: Refer to **“Line Rating”** & **“PEAK LOAD CAPABILITY”**
- Note6: Measurements are made with a 0.1µF MLCC & 10µF E-cap in parallel across output. (low ESR)

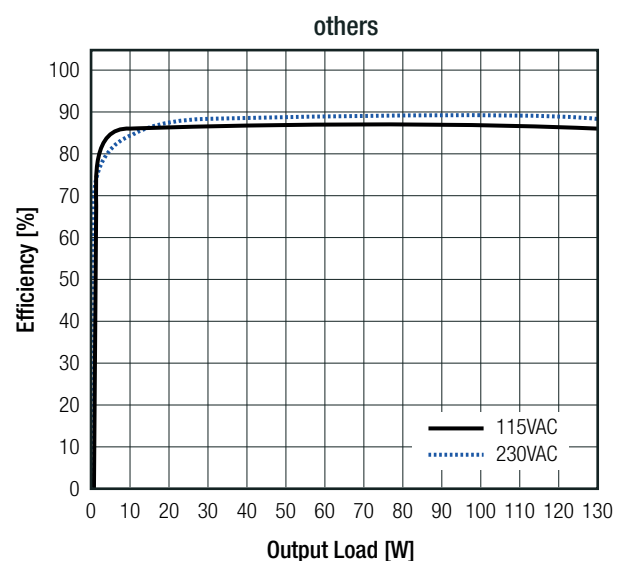
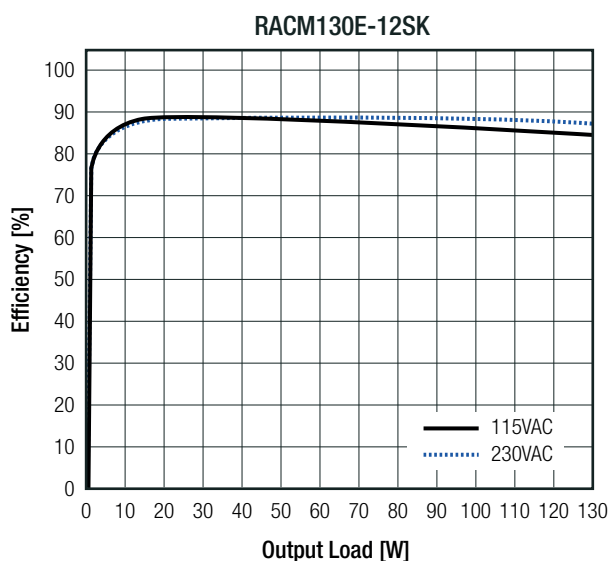
**Efficiency vs. Load**

**Specifications** (measured @ Ta= 25°C, nom. Vin, 130W @1m/s airflow and after warm-up unless otherwise stated)

REGULATIONS		
Parameter	Condition	Value
Output Accuracy		±2.0% typ.
Line Regulation	low line to high line, full load	±0.5% typ.
Load Regulation <sup>(7)</sup>	10% to 100% load	1.0% typ.
Transient Response	25% load step change	4.0% max.
	recovery time	500µs max.

**Notes:**

Note7: Operation below 10% load will not harm the converter, but specifications may not be met

**Deviation vs. Load**  
(@ 115-230VAC)

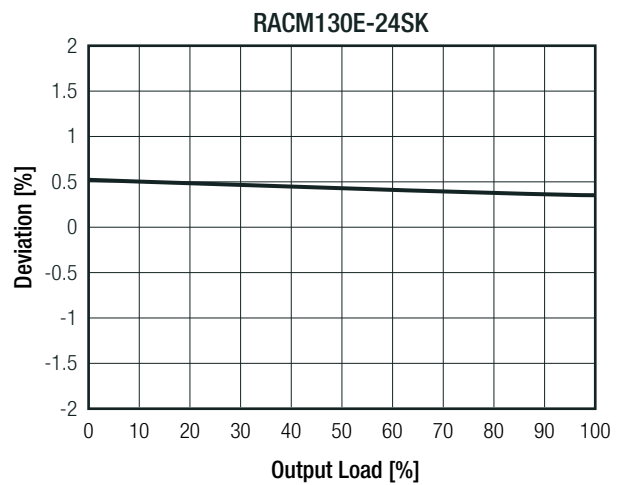
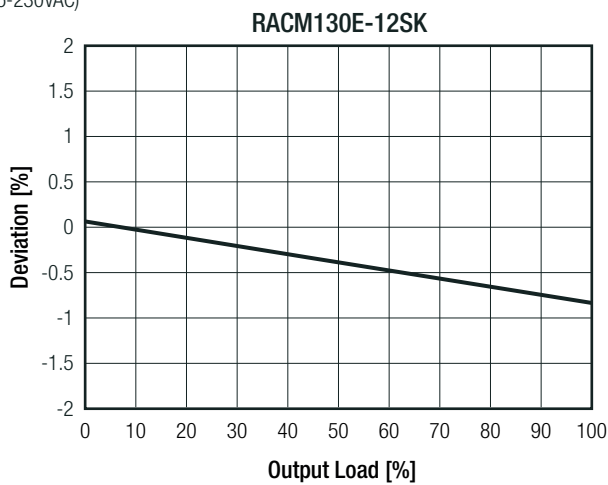

PROTECTIONS			
Parameter	Type	Value	
Internal Input Fuse	L and N (dual fusing)	T4A, slow blow type	
Short Circuit Protection (SCP)		hiccup, auto recovery	
Over Voltage Protection (OVP)		120% - 180%, auto recovery	
Over Voltage Category	according to 61558-2-16	OVCIII (up to 2000m)	
	according to 60601-1	OVCII	
Over Current Protection (OCP)		110% - 180%, auto recovery	
Isolation Voltage <sup>(8)</sup>	I/P to O/P	1 minute	
Isolation Resistance	I/P to O/P, V <sub>ISO</sub> = 500VDC	1GΩ min.	
Isolation Capacitance	I/P to O/P, 100kHz/0.1V	100pF max.	
Touch Current	264VAC/63Hz	NC	<100µA
		SFC	<500µA
Insulation Grade		reinforced	
Means of Protection	≤300Vrms working voltage	2MOPP	

**Notes:**

Note8: For repeat Hi-Pot testing, reduce the time and/or the test voltage

**Specifications** (measured @  $T_a = 25^\circ\text{C}$ , nom.  $V_{in}$ , 130W @ 1m/s airflow and after warm-up unless otherwise stated)

### ENVIRONMENTAL

Parameter	Condition	Value	
Operating Temperature Range	with derating @ natural convection 0.1m/s	-40°C to +90°C	
Temperature Coefficient		$\pm 0.05\%/K$	
Operating Altitude	according to 60601-1	4000m (OVCI)	
	according to 61558-2-16	2000m (OVCI)	
Operating Humidity	non-condensing	5% - 95% RH max.	
Pollution Degree		PD2	
Vibration	according to MIL-STD-202G	10-500Hz, 5G 10min./1cycle, period 60min. along x,y,z axes	
MTBF	according to MIL-HDBK-217F, G.B.	$T_{AMB} = +25^\circ\text{C}$	$>600 \times 10^3$ hours
		$T_{AMB} = +40^\circ\text{C}$	$>450 \times 10^3$ hours
Design Lifetime	230VAC/50Hz and full load at +25°C	$>30 \times 10^3$ hours	

### Still air convection cooled ratings

#### RACM130E-K/OF

(@ natural convection 0.1m/s)

#### 100VAC

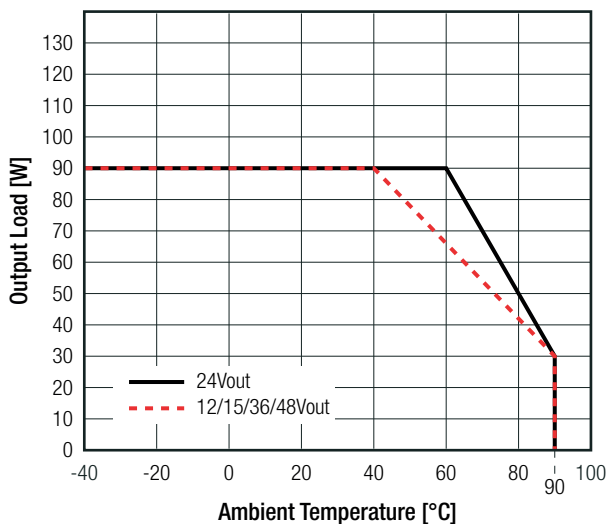

#### 120-240VAC

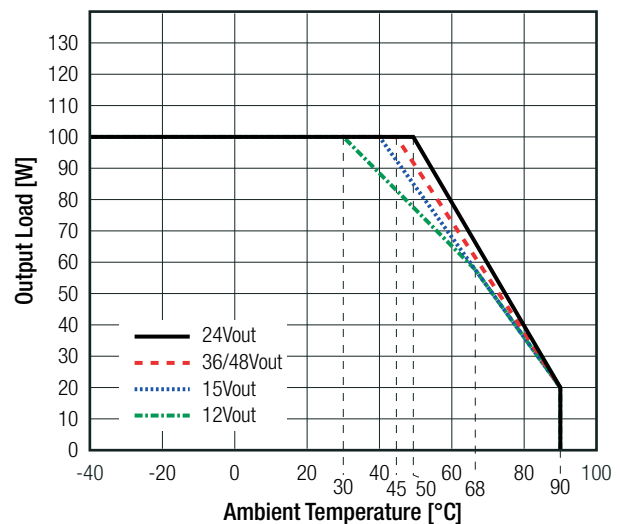

#### RACM130E-K/ENC

(@ natural convection 0.1m/s)

#### 100VAC

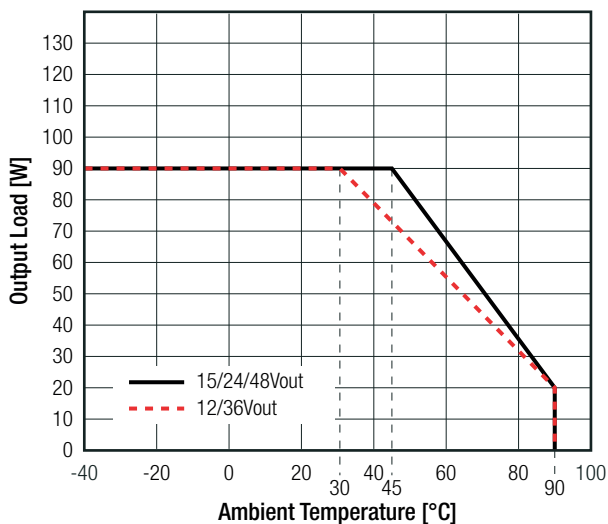

#### 120-240VAC

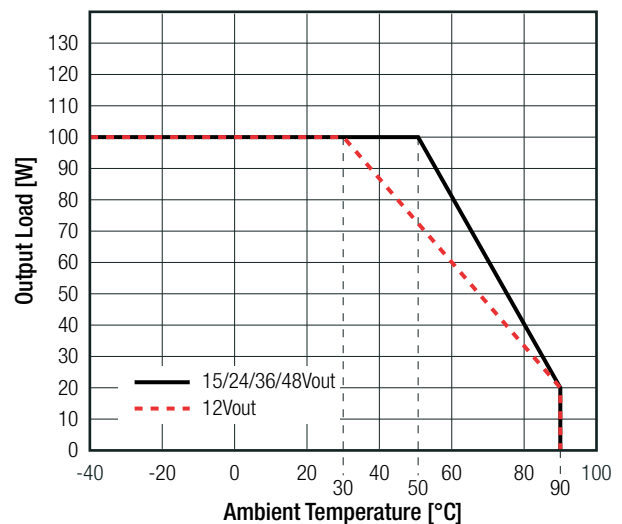

continued on next page

**Specifications** (measured @ Ta= 25°C, nom. Vin, 130W @1m/s airflow and after warm-up unless otherwise stated)

### Thermal Derating for externally provided forced air

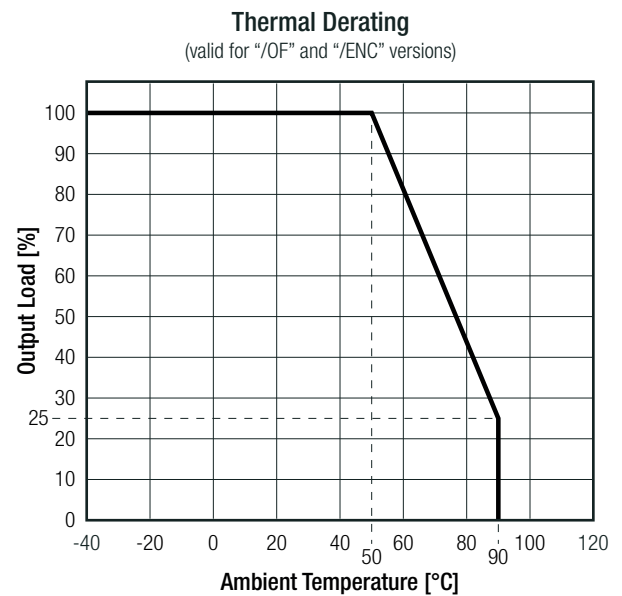
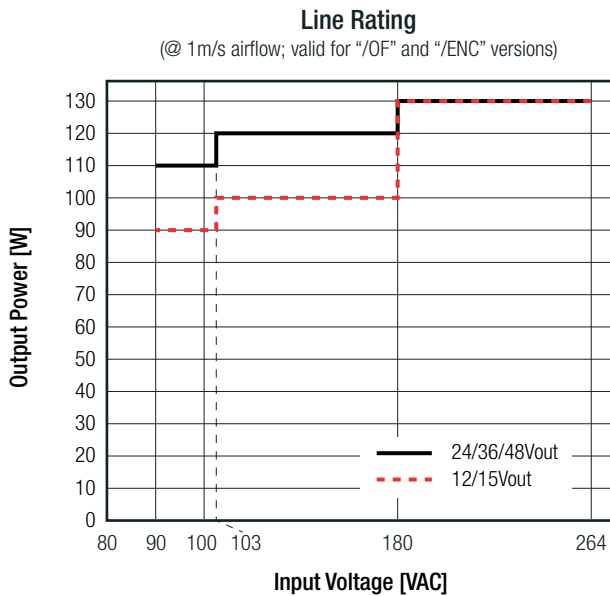

### PEAK LOAD CAPABILITY (@ 0.1 m/s natural convection; valid for "/OF" and "/ENC" versions)

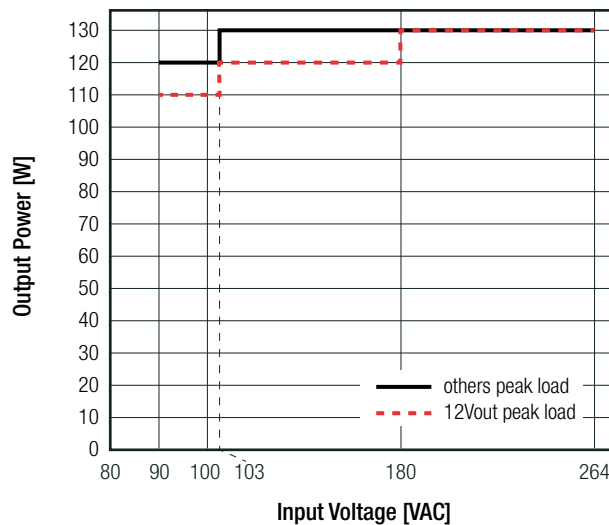

#### Calculation for recovery power:

- $P_p$  = peak output power ( $\leq 130W$ ) [W]
- $P_r$  = recovery output power [W]
- $t_1$  = peak time set (10s max.) [s]
- $t_2$  = recovery time (min.  $3 \times t_1$ ) [s]
- $k$  = safety factor 1.2 [ ]

$$P_r = \frac{100 \times (t_1 + t_2) - (P_p \times t_1)}{t_2 \times k}$$

#### Practical Example (RACM130E-24SK/OF):

Take the RACM130E-24SK/OF at 230VAC input Voltage and full load at  $T_{AMB} = 25^\circ C$ , with natural convection.

- $P_p = 130W$
- $t_1 = 10s$
- $t_2 = 30s$
- $k = 1.2$

$$P_r = \frac{100 \times (10 + 30) - (130 \times 10)}{30 \times 1.2} = 75W$$

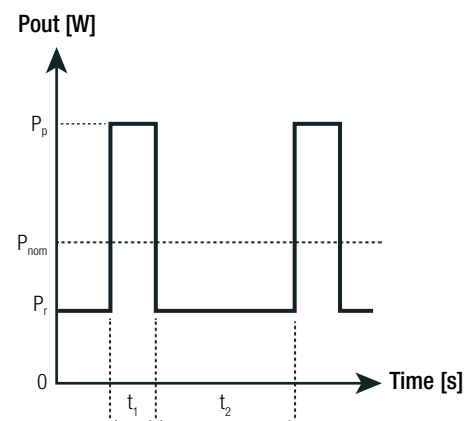

**Specifications** (measured @ Ta= 25°C, nom. Vin, 130W @1m/s airflow and after warm-up unless otherwise stated)

<b>SAFETY AND CERTIFICATIONS</b>		
<b>Certificate Type (Safety)</b>	<b>Report Number</b>	<b>Standard</b>
Medical electrical equipment Part 1: General requirements for basic safety and essential performance	E511305-D1002-1/A0/C0-UL	CAN/CSA-C22.2 No. 60601-1:14, 3rd Edition ANSI/AAMI ES60601-1:2005 + A2:2020
Medical electrical equipment Part 1: General requirements for basic safety and essential performance		IEC60601-1:2005 + AM1:2012 3rd Edition EN60601-1:2006 + A12:2014
Audio/Video, information and communication technology equipment - Safety requirements (CB Scheme)	pending	IEC62368-1:2014
Audio/Video, information and communication technology equipment - Safety requirements (LVD)	pending	EN62368-1:2014
Household and similar electrical appliances – Safety – Part 1: General requirements (LVD)	pending	IEC60335-1:2010 EN60335-1:2012
Safety of power transformers, power supplies, reactors & similar products for supply voltages up to 1100 V Part 2: Particular requirements (CB Scheme)	pending	IEC61558-2-16:2009
Safety of power transformers, power supplies, reactors & similar products for supply voltages up to 1100 V Part 2: Particular requirements	pending	EN61558-2-16:2009
Safety of power transformers, power supplies, reactors and similar products for supply voltages up to 1100 V (CB Scheme)	pending	IEC61558-1:2017
Safety of power transformers, power supplies, reactors and similar products for supply voltages up to 1100 V (CB Scheme)		EN IEC 61558-1:2019
RoHS2		RoHS 2011/65/EU + AM2015/863
<b>EMC Compliance (EN61204-3)</b>	<b>Condition</b>	<b>Standard / Criterion</b>
Low voltage power supplies, d.c. output Part 3: Electromagnetic compatibility	JYTAB-R01-2100249	EN/IEC61204-3:2018
ESD Electrostatic discharge immunity test	Contact: ±4kV	EN61000-4-2:2009, Criteria B
Radiated, radio-frequency, electromagnetic field immunity test	10V/m (80-1000MHz) 3V/m (1400-2000MHz) 1V/m (2000-2700MHz)	EN61000-4-3:2006, Criteria A
Fast Transient and Burst Immunity	AC Port: L-N 2kV	EN61000-4-4:2012, Criteria A
Surge Immunity	AC Port: L-N 0,5, 1kV	EN61000-4-5:2014, Criteria A
Immunity to conducted disturbances, induced by radio-frequency fields	AC Port: 10Vrms (0.15-80MHz)	EN61000-4-6:2014, Criteria A
Power Magnetic Field Immunity	30A/m	EN61000-4-8:2010; Criteria A
Voltage Dips and Interruptions	Dips: 100% (0.5, 1.0P), 30%, 20% 60% Interruptions: 100%	EN61000-4-11:2004, Criteria A EN61000-4-11:2004, Criteria B EN61000-4-11:2004, Criteria B
Limits of Voltage Fluctuations & Flicker		EN61000-3-3:2013
<b>EMC Compliance (EN55032)</b>	<b>Condition</b>	<b>Standard / Criterion</b>
Electromagnetic compatibility of multimedia equipment - Emission requirements	JYTAB-R01-2100250	EN55032:2015
Electromagnetic compatibility of multimedia equipment - Immunity requirements		EN55035:2017
ESD Electrostatic discharge immunity test	Contact: ±2, 4kV	EN61000-4-2:2009, Criteria B
Radiated, radio-frequency, electromagnetic field immunity test	3 V/m (80-5000MHz)	EN61000-4-3:2006+A2:2010, Criteria A
Fast Transient and Burst Immunity	AC Port: L-N 1kV	EN61000-4-4:2012, Criteria A
Surge Immunity	AC Port: L-N 0,5, 1kV	EN61000-4-5:2014, Criteria A
Immunity to conducted disturbances, induced by radio-frequency fields	AC Port: 3Vrms (0.15-10MHz) 3-1Vrms (10-30MHz) 1Vrms (30-80MHz)	EN61000-4-6:2014, Criteria A
Power Magnetic Field Immunity	1A/m	EN61000-4-8:2010, Criteria A
Voltage Dips and Interruptions	Dips: 100%, 30% Interruptions:100%	EN61000-4-11:2004 , Criteria A EN61000-4-11:2004, Criteria B
Limits of Harmonic Current Emissions		EN61000-3-2:2014
Limits of Voltage Fluctuations & Flicker		EN61000-3-3:2013

**Specifications** (measured @ Ta= 25°C, nom. Vin, 130W @1m/s airflow and after warm-up unless otherwise stated)

### DIMENSION AND PHYSICAL CHARACTERISTICS

Parameter	Type	Value
Material	PCB	FR4, (UL94-V0)
	baseplate / case ("/ENC)	aluminum
Dimension (LxWxH)	"/OF" Version	101.6 x 50.8 x 32.0mm
	"/ENC" Version	118.3 x 62.7 x 38.7mm
Weight	"/OF" Version	200g typ.
	"/ENC" Version	260g typ.

Dimension Drawing "/OF"(mm)

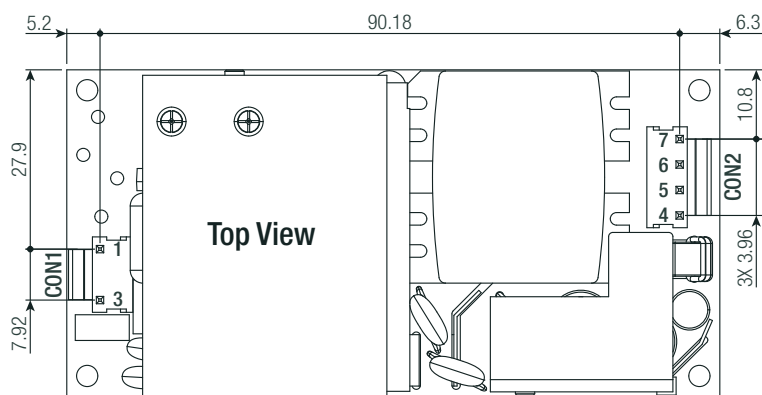

AC Input Side View

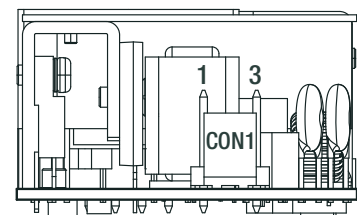

DC Output Side View

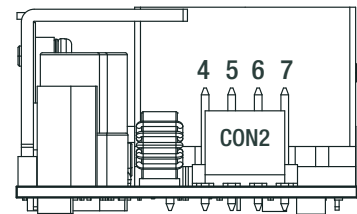

Side View

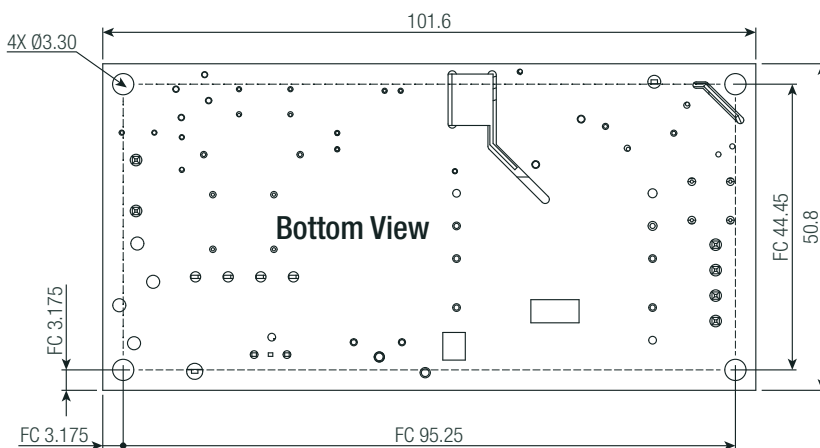
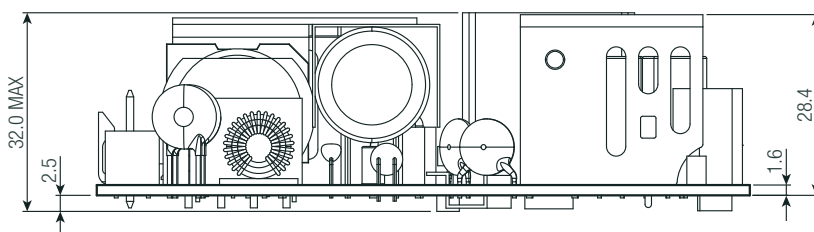

### Connector Information

#	Function	Terminal
<b>AC Input (CON1)</b>		
1	VAC in (N)	3 Pins (Pin2 removed)
3	VAC in (L)	with 3.96mm pitch
<b>DC Output (CON2)</b>		
4,5	+VDC out	4 Pins
6,7	-VDC out	with 3.96mm pitch

FC= fixing centers

### Compatible Connector

#### Housing

Molex 41695 Series or equivalent

#### Crimp Terminal

Molex 2478 Series or equivalent

Tolerances: xx.x= ±0.5mm  
xx.xx= ±0.25mm

continued on next page

Specifications (measured @ Ta= 25°C, nom. Vin, 130W @1m/s airflow and after warm-up unless otherwise stated)

Dimension Drawing "/ENC"(mm)

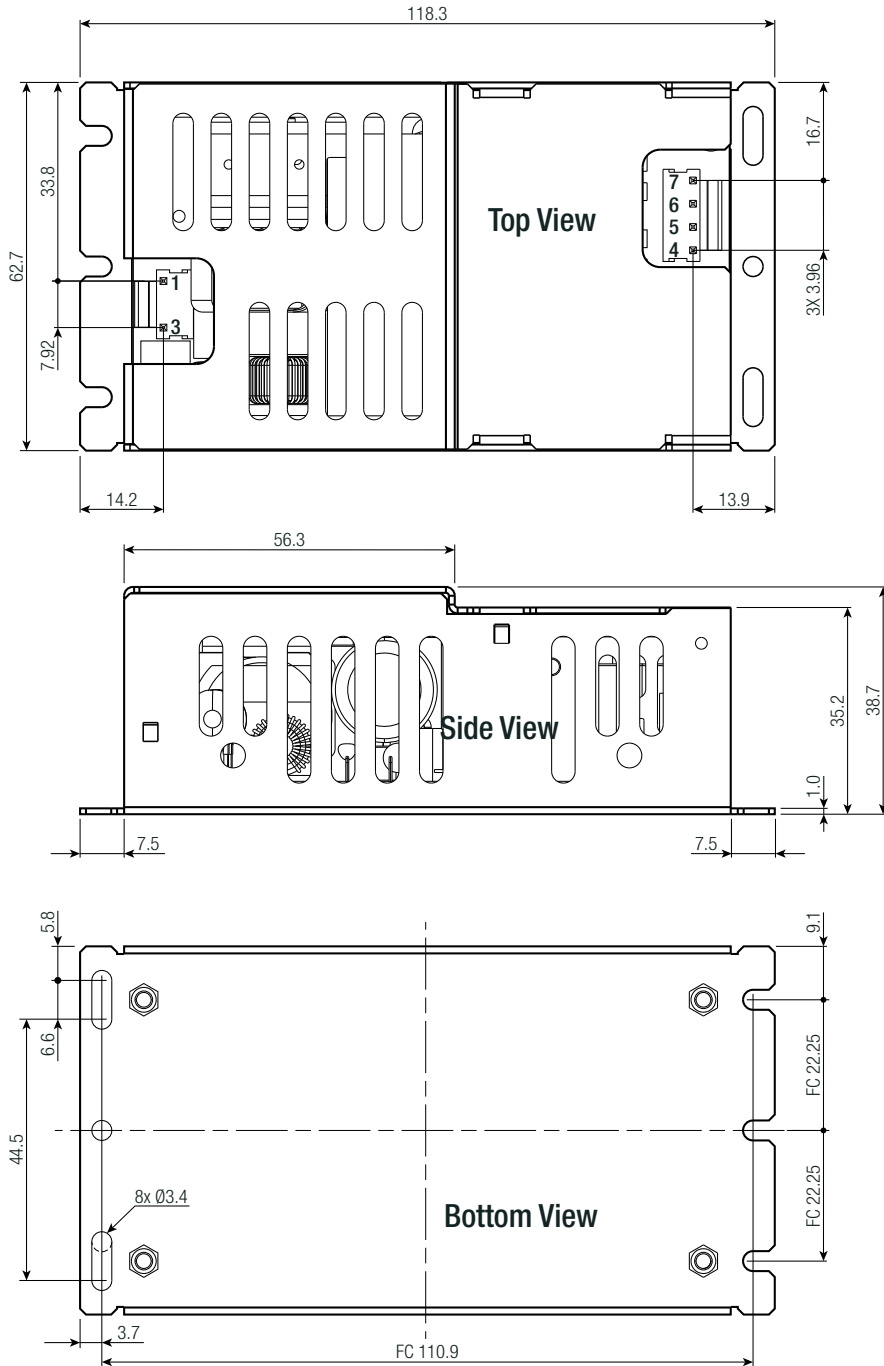

AC Input Side View

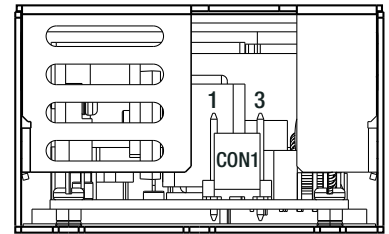

DC Output Side View

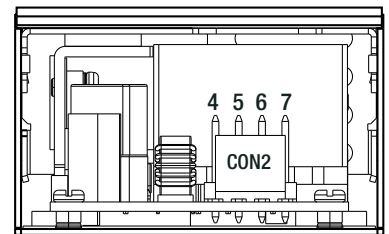

**Connector Information**

#	Function	Terminal
<b>AC Input (CON1)</b>		
1	VAC in (N)	3 Pins (Pin2 removed)
3	VAC in (L)	with 3.96mm pitch
<b>DC Output (CON2)</b>		
4,5	+VDC out	4 Pins
6,7	-VDC out	with 3.96mm pitch

FC= fixing centers

**Compatible Connector**

**Housing**

Molex 41695 Series or equivalent

**Crimp Terminal**

Molex 2478 Series or equivalent

Tolerances: xx.x= ±0.5mm  
xx.xx= ±0.25mm



Specifications (measured @ Ta= 25°C, nom. Vin, 130W @1m/s airflow and after warm-up unless otherwise stated)

**APPLICATION AND INSTALLATION**

**Mounting**

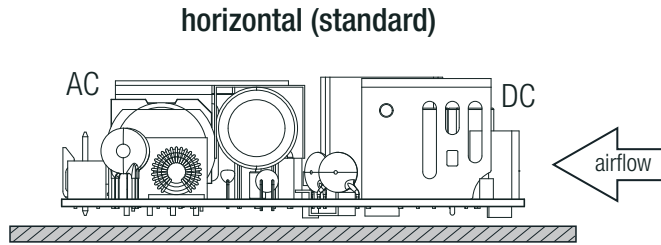
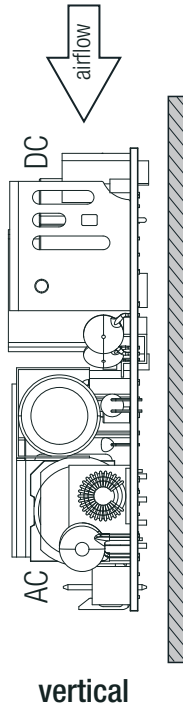

If module is mounted vertical or upside-down with natural convection cooling, the power must be derated  $\geq 10\%$ .

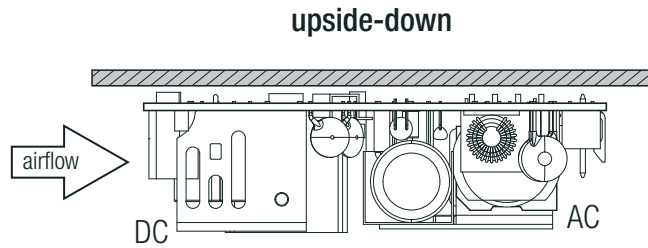

**Blockdiagram ("OF")**

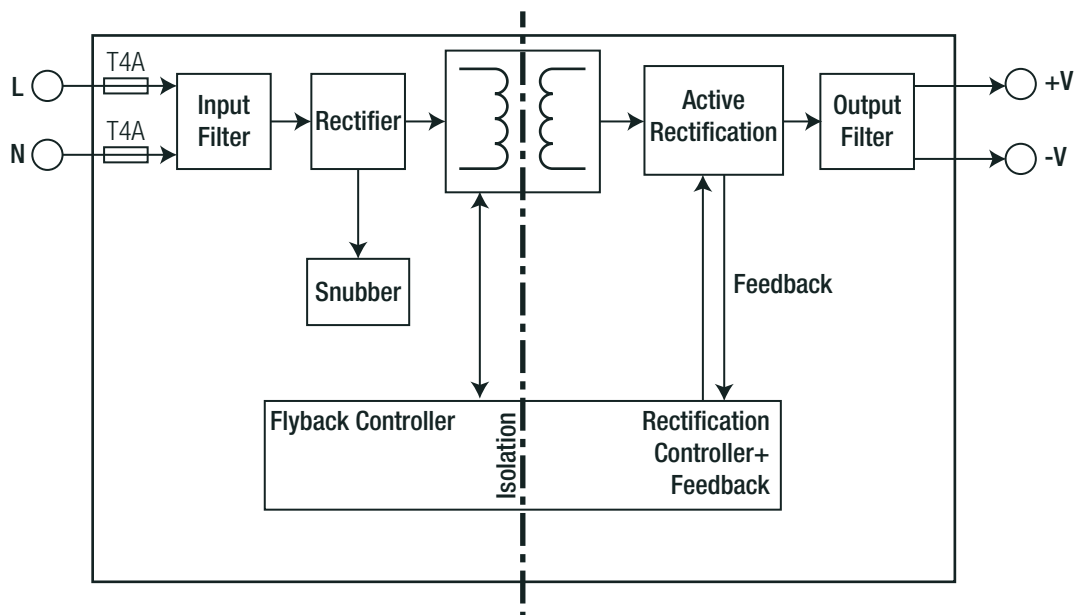

continued on next page

**Specifications** (measured @ Ta= 25°C, nom. Vin, 130W @1m/s airflow and after warm-up unless otherwise stated)

**APPLICATION AND INSTALLATION**

Blockdiagram (“/ENC”)

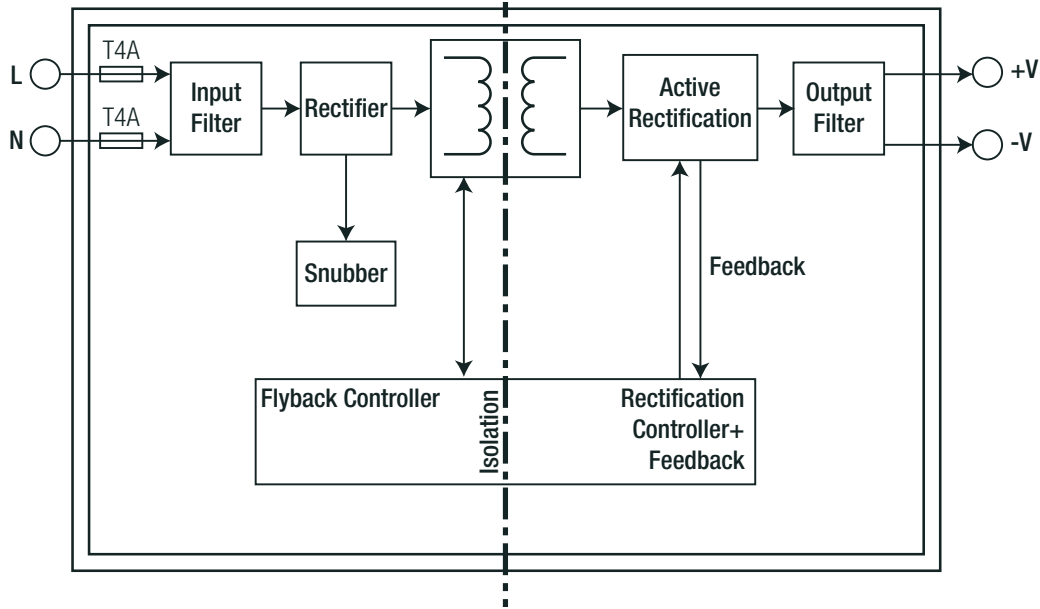

**PACKAGING INFORMATION**

Parameter	Type		Value
Packaging Dimension (LxWxH)	“/OF” type	tray	365.0 x 210.0 x 56.0mm
	“/ENC” type		435.0 x 370.0 x 94.0mm
Packaging Quantity	“/OF” type		9pcs
	“/ENC” type		18pcs
Storage Temperature Range			-40°C to +90°C
Storage Humidity	non-condensing		95% max.

The product information and specifications may be subject to changes even without prior written notice. The product has been designed for various applications; its suitability lies in the responsibility of each customer. The products are not authorized for use in safety-critical applications without RECOM's explicit written consent. A safety-critical application is an application where a failure may reasonably be expected to endanger or cause loss of life, inflict bodily harm or damage property. The applicant shall indemnify and hold harmless RECOM, its affiliated companies and its representatives against any damage claims in connection with the unauthorized use of RECOM products in such safety-critical applications.