

# Features

# Unregulated Converters

- Fully RoHS 10/10 conform
- Full power at 100°C ambient temperature
- 1kVDC or 3kVDC isolation option
- Suitable for fully automated assembly (including vapor phase soldering)
- Optional continuous short circuit protection



# R0.25S & R0.25D(A)

0.25 Watt  
SMD  
Single, Dual and Independent Outputs



UL60950-1 certified  
CAN/CSA-C22.2 No. 60950-1-07 certified  
IEC/EN60950-1 certified  
EN55032 compliant  
CB report

## Description

The R0.25S and R0.25D converters are of the enclosed open frame type, i.e. they are not potted. The converters are typically used in general purpose and industrial low over isolation and voltage matching applications where an SMD converter is required. The converter series feature an extended ambient temperature operating range of -40°C to +100°C without derating and optional continuous short circuit protection. In addition to single, dual and independent outputs, two isolation options and three different case formats, the converters are also available prepacked as tape and reel for use with automatic insertion machines.

## Selection Guide

Part Number	nom. Input Voltage [VDC]	Output Voltage [VDC]	Output Current [mA]	max. Capacitive Load <sup>(2)</sup> [µF]
R0.25S <sup>(3)</sup> -xx3.3 <sup>(4,5)</sup>	3.3, 5, 12, 15, 24	3.3	76	1000
R0.25S <sup>(3)</sup> -xx05 <sup>(4,5)</sup>	3.3, 5, 12, 15, 24	5	50	470
R0.25S <sup>(3)</sup> -xx09 <sup>(4,5)</sup>	3.3, 5, 12, 15, 24	9	28	470
R0.25S <sup>(3)</sup> -xx12 <sup>(4,5)</sup>	3.3, 5, 12, 15, 24	12	21	150
R0.25S <sup>(3)</sup> -xx15 <sup>(4,5)</sup>	3.3, 5, 12, 15, 24	15	17	68
R0.25S <sup>(3)</sup> -xx24 <sup>(4,5)</sup>	3.3, 5, 12, 15, 24	24	10.4	68
R0.25D <sup>(3)</sup> -xx3.3 <sup>(4,5)</sup>	3.3, 5, 12, 15, 24	±3.3	±38	470
R0.25D <sup>(3)</sup> -xx05 <sup>(4,5)</sup>	3.3, 5, 12, 15, 24	±5	±25	220
R0.25D <sup>(3)</sup> -xx09 <sup>(4,5)</sup>	3.3, 5, 12, 15, 24	±9	±14	68
R0.25D <sup>(3)</sup> -xx12 <sup>(4,5)</sup>	3.3, 5, 12, 15, 24	±12	±10.4	68
R0.25D <sup>(3)</sup> -xx15 <sup>(4,5)</sup>	3.3, 5, 12, 15, 24	±15	±8.3	68
R0.25D <sup>(3)</sup> -xx24 <sup>(4,5)</sup>	3.3, 5, 12, 15, 24	±24	±5.2	33
R0.25DA <sup>(3)</sup> -xx0505 <sup>(4,5)</sup>	3.3, 5, 12, 15, 24	5/5	25/25	220/220
R0.25DA <sup>(3)</sup> -xx1212 <sup>(4,5)</sup>	3.3, 5, 12, 15, 24	12/12	10/10	68/68

### Notes:

- Note1: Efficiency is tested at nominal input and full load at +25°C ambient  
 Note2: Max Cap Load is tested at nominal input and full resistive load and is defined as the capacitive load that will allow start up in under 1s without damage to the converter

## Model Numbering



### Notes:

- Note3: R0.25S: without marking denotes 5 pins out of 8 fitted (includes /H option)  
 with marking "8" denotes 8 pins out of 8 fitted (/H option not available)  
 with marking "12" denotes 10 pins out of 12 fitted (includes /H option)  
 R0.25D: without marking denotes "6" pins out of 10 fitted (includes /H option)  
 R0.25D(A): with marking "10" denotes 10(7) pins out of 10 fitted (/H option not available)  
 R0.25D: with marking "12" denotes 10 pins out of 12 fitted (includes /H option)  
 Note4: standard part is without continuous short circuit protection  
 add suffix „/P“ for continuous short circuit protection  
 add suffix „/H“ for 3kVDC isolation (not available for R0.25S8, R0.25D10 and R0.25DA10)  
 or add suffix „/HP“ for 3kVDC isolation and continuous short circuit protection  
 Note5: add suffix „-R“ for tape and reel packaging (compatible with all other suffixes)

**Specifications** (measured @ Ta= 25°C, nom. Vin, full load and after warm-up unless otherwise stated)

### BASIC CHARACTERISTICS

Parameter	Condition	Min.	Typ.	Max.
Input Voltage Range			±10%	
Efficiency		60%		70%
Minimum Load		0%		
Internal Operating Frequency		20kHz	50kHz	90kHz
Output Ripple and Noise	20MHz BW			100mVp-p

### Efficiency vs. Load

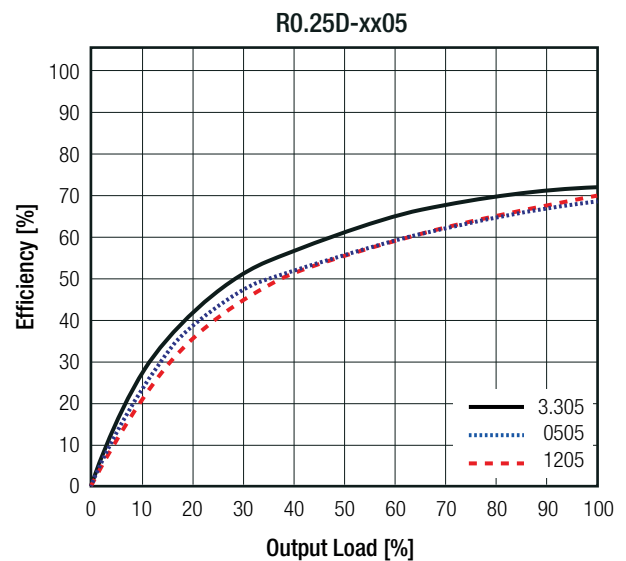
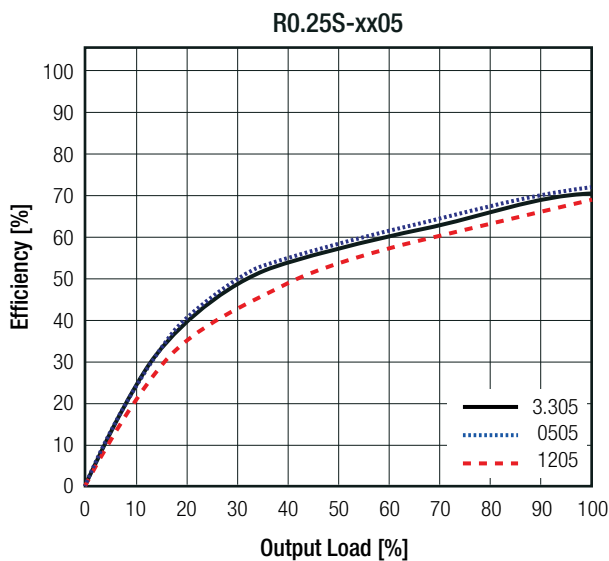

### REGULATIONS

Parameter	Condition		Value
Output Accuracy			±5.0% typ. / ±7.0% max.
Line Regulation	low line to high line, full load		2.0% max.
Load Regulation <sup>(6)</sup>	10% to 100% load	3.3Vout	15.0% typ. / 20.0% max.
		5, 5/5Vout	12.0% typ. / 15.0% max.
		9Vout	7.0% typ. / 10.0% max.
		12, 12/12, 15, 24Vout	6.0% typ. / 10.0% max.

**Notes:**

Note6: Operation below 10% load will not harm the converter, but specifications may not be met

### Tolerance Envelope

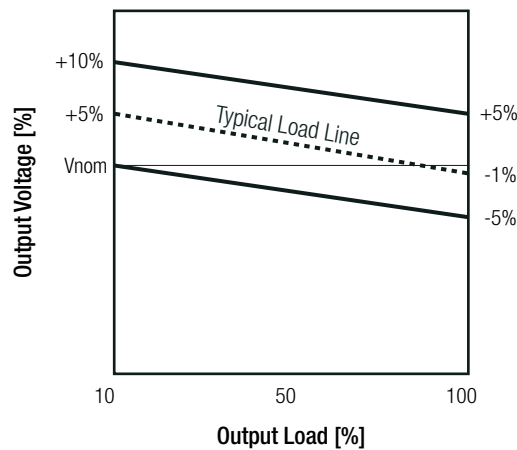

continued on next page

**Specifications** (measured @ Ta= 25°C, nom. Vin, full load and after warm-up unless otherwise stated)

Deviation vs. Load

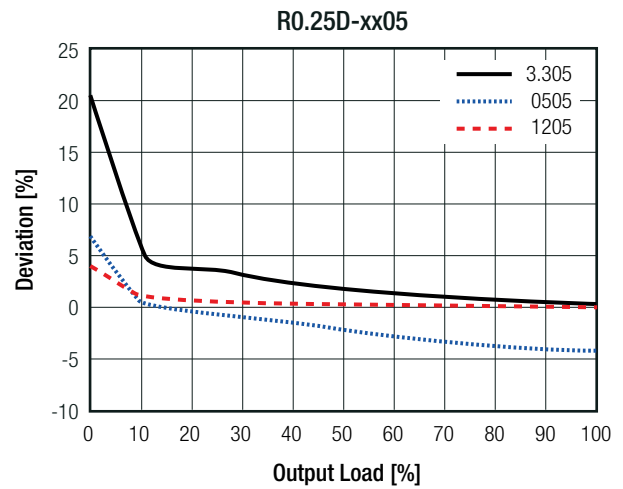
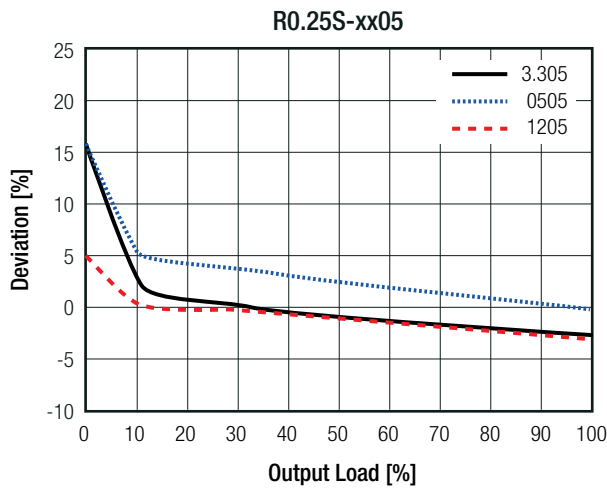

## PROTECTIONS

Parameter	Type		Value
Short Circuit Protection (SCP)	below 100mΩ	without suffix with suffix "/P"	1 second continuous
Isolation Voltage <sup>(7)</sup>	I/P to O/P	without suffix	1kVDC 500VAC/60Hz
		with suffix "/H"	3kVDC 1.5kVAC/60Hz
	O/P to O/P	R0.25DA	1kVDC
Isolation Resistance	Viso=500V		10GΩ min.
Isolation Capacitance			75pF max.
Insulation Grade			functional

**Notes:**

Note7: For repeat Hi-Pot testing, reduce the time and/or the test voltage

Note8: Refer to local safety regulations if input over-current protection is also required. Recommended fuse: slow blow type

## ENVIRONMENTAL

Parameter	Condition		Value
Operating Temperature Range	full load @ free air convection, refer to "Derating Graph"		-40°C to +100°C
Operating Altitude			2000m
Operating Humidity	non-condensing		95% RH max.
Pollution Degree			PD2
MTBF	according to MIL-HDBK-217F, G.B.	+25°C	4423 x 10 <sup>3</sup> hours
		+85°C	2161 x 10 <sup>3</sup> hours

continued on next page

**Specifications** (measured @ Ta= 25°C, nom. Vin, full load and after warm-up unless otherwise stated)

### Derating Graph

(@ Chamber and free air convection)

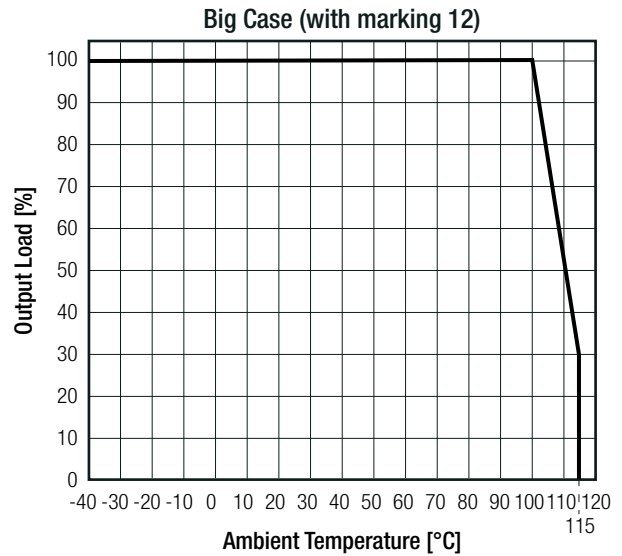
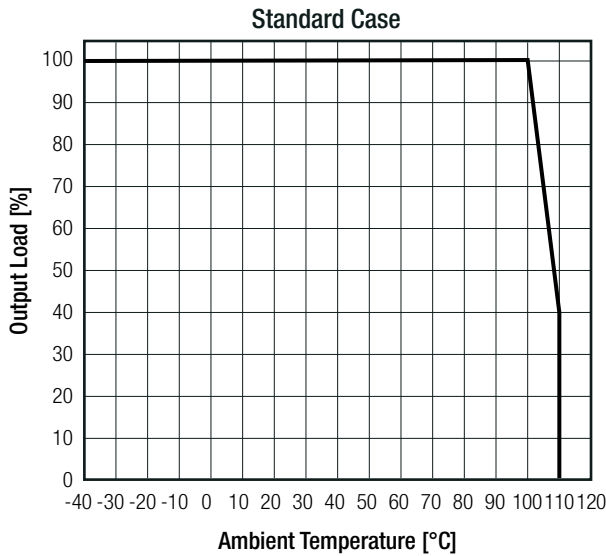

### SAFETY AND CERTIFICATIONS

Certificate Type (Safety)	Report / File Number	Standard
Information Technology Equipment, General Requirements for Safety	E358085-A2-UL	UL60950-1, 2nd Edition:2007 CAN/CSA C22.2 No. 60950-1-07, 2nd Edition:2007
Information Technology Equipment, General Requirements for Safety	LVD1605077-08	IEC60950-1:2005, 2nd Edition + A2:2013 EN60950-1:2006 + A2:2013
Information Technology Equipment, General Requirements for Safety (CB Scheme)	E322406-A2-CB-1	IEC60950-1:2001, 1st Edition
Medical Electrical Equipment Part 1: General Requirements for Basic Safety and Essential Performance	WD-SE-R-180674-A0	IEC60601-1:2005 + A1:2012, 3rd Edition EN60601-1:2006 + A12:2014
EAC	RU-AT.49.09571	TP TC 004/2011
RoHS2		RoHS-2011/65/EU + AM-2015/863

EMC Compliance	Condition	Standard / Criterion
Electromagnetic compatibility of multimedia equipment - Emission requirements	with external filter (see filter suggestion below)	EN55032, Class B

### EMC Filtering Suggestions according to EN55032 Class B

#### Single Output

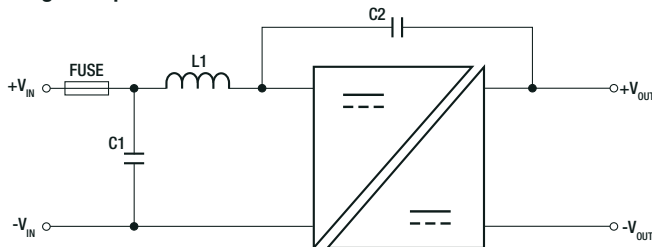

#### Dual Output

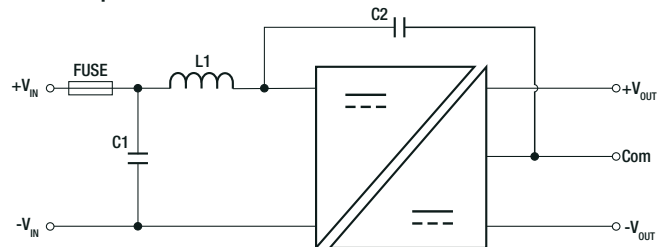

### Component List Class B

nom. Vin	C1	C2	L1
3.3VDC	2.2µF MLCC	470pF/4kVDC	3.3µH SMD Inductor
5VDC			4.7µH SMD Inductor
12, 15VDC	1.0µF MLCC		2.2µH SMD Inductor
24VDC	470nF MLCC		47µH SMD Inductor

**Specifications** (measured @ Ta= 25°C, nom. Vin, full load and after warm-up unless otherwise stated)

**EMC Filtering Suggestions according to EN55032 Class B  
Dual Independent Output**

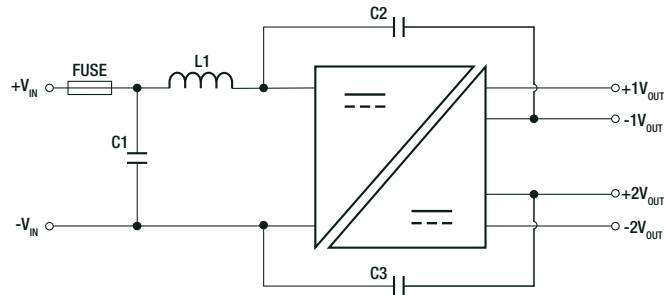

**Component List Class B**

nom. Vin	C1	C2	C3	L1
3.3VDC	2.2µF MLCC	470pF/2kVDC	470pF/2kVDC	3.3µH SMD Inductor
5VDC				4.7µH SMD Inductor
12, 15VDC	1.0µF MLCC			2.2µH SMD Inductor
24VDC	470nF MLCC			47µH SMD Inductor

**DIMENSION AND PHYSICAL CHARACTERISTICS**

Parameter	Type	Value
Material	case	non-conductive black plastic, (UL94 V-0)
Dimension (LxWxH)	R0.25S, R0.25S8	12.75 x 10.7 x 6.7mm
	R0.25S12, R0.25D, R0.25D10, R0.25D12	15.25 x 10.7 x 6.7mm
Weight	R0.25S	1.0g typ.
	R0.25S8	1.1g typ.
	R0.25S12, R0.25D, R0.25D(A)10, R0.25D(A)12	1.2g typ.

**Dimension Drawing (mm)**

**5 Pin Single SMD Package**

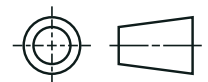

/H option is available in this pin package

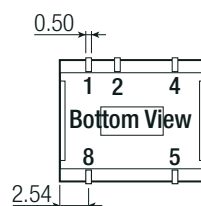
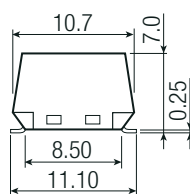
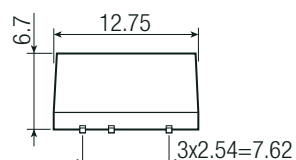
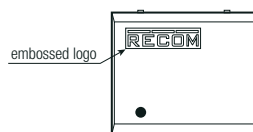

**Recommended Footprint Details**

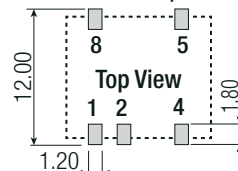

**Pinning Information**

Pin #	Single
1	-Vin
2	+Vin
4	-Vout
5	+Vout
8	NC

NC = No Connection

Tolerance:

xx.x= ±0.5mm

xx.xx= ±0.25mm

continued on next page

**Specifications** (measured @ Ta= 25°C, nom. Vin, full load and after warm-up unless otherwise stated)

Dimension Drawing (mm)

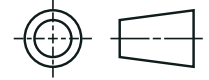

6 Pin Dual SMD Package

/H option is available in this pin package

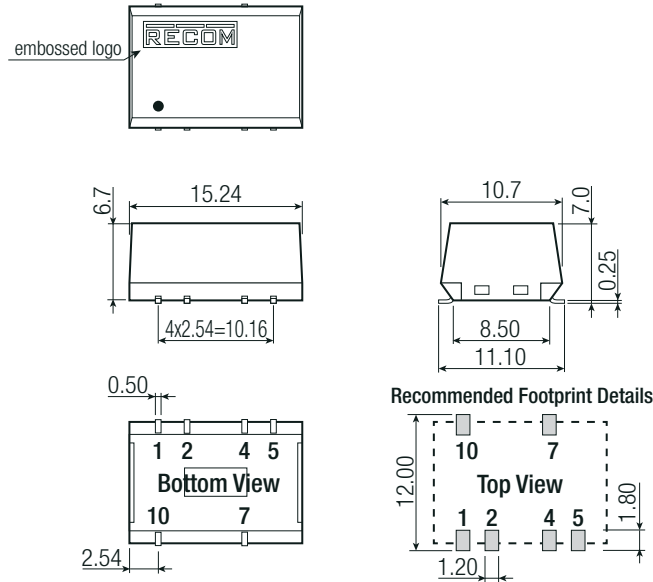

**Pinning Information**

Pin #	Dual
1	-Vin
2	+Vin
4	Com
5	-Vout
7	+Vout
10	NC

NC = No Connection

Tolerance:

xx.x= ±0.5mm

xx.xx= ±0.25mm

8 Pin Single SMD Package

/H option is not available in this pin package

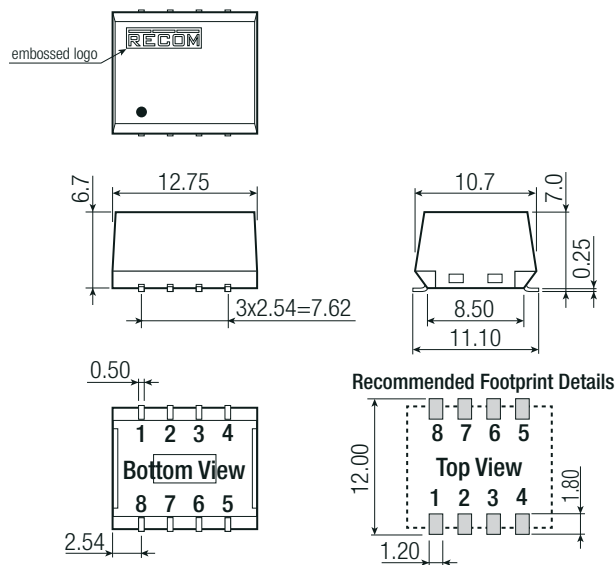

**Pinning Information**

Pin #	Single
1	-Vin
2	+Vin
3	NC
4	-Vout
5	+Vout
6	NC
7	NC
8	NC

NC = No Connection

Tolerance:

xx.x= ±0.5mm

xx.xx= ±0.25mm

continued on next page

**Specifications** (measured @ Ta= 25°C, nom. Vin, full load and after warm-up unless otherwise stated)

Dimension Drawing (mm)

### 10 Pin Dual SMD Package

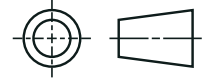

/H option is not available in this pin package

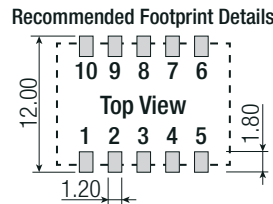
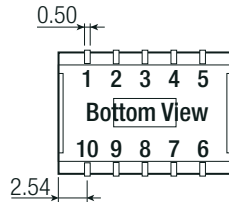
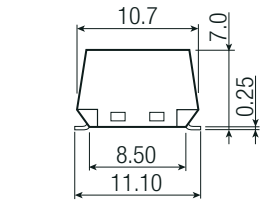
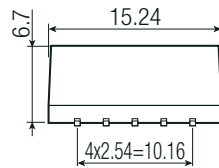
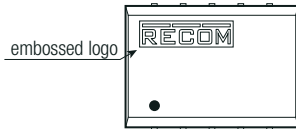

#### Pinning Information

Pin #	Dual	Independent
1	-Vin	-Vin
2	+Vin	+Vin
3	NC	no pin
4	Com	-Vout1
5	-Vout	+Vout1
6	NC	-Vout2
7	+Vout	+Vout2
8	NC	no pin
9	NC	no pin
10	NC	NC

NC = No Connection

Tolerance:

xx.x= ±0.5mm

xx.xx= ±0.25mm

### 12 Pin Single and Dual SMD Package

/H option is available in this pin package

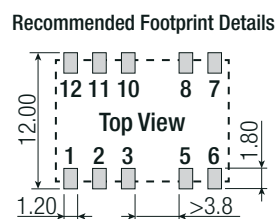
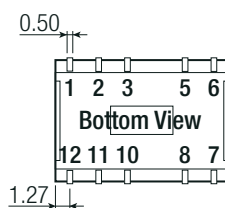
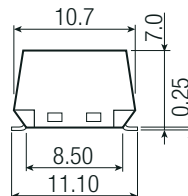
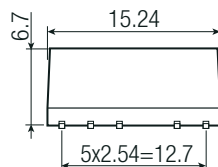
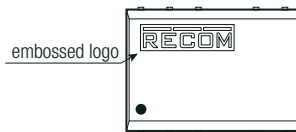

#### Pinning Information

Pin #	Single	Dual
1	-Vin	-Vin
2	+Vin	+Vin
3	NC	NC
5	-Vout	Com
6	NC	-Vout
7	NC	NC
8	+Vout	+Vout
10	NC	NC
11	NC	NC
12	NC	NC

NC = No Connection

Tolerance:

xx.x= ±0.5mm

xx.xx= ±0.25mm

**Specifications** (measured @ Ta= 25°C, nom. Vin, full load and after warm-up unless otherwise stated)

PACKAGING INFORMATION			
Packaging Dimension (LxWxH)	tube tape and reel (carton)		530.0 x 17.0 x 14.0mm 355.0 x 342.0 x 36.0mm
Packaging Quantity	tube	R0.25S, R0.25S8	40pcs
		R0.25S12, R0.25D, R0.25D(A)10, R0.25D(A)12	33pcs
	tape and reel		500pcs
Tape Width			24.0mm
Storage Temperature Range			-55°C to +125°C
Storage Humidity	non-condensing		95% RH max.

The product information and specifications may be subject to changes even without prior written notice. The product has been designed for various applications; its suitability lies in the responsibility of each customer. The products are not authorized for use in safety-critical applications without RECOM's explicit written consent. A safety-critical application is an application where a failure may reasonably be expected to endanger or cause loss of life, inflict bodily harm or damage property. The applicant shall indemnify and hold harmless RECOM, its affiliated companies and its representatives against any damage claims in connection with the unauthorized use of RECOM products in such safety-critical applications.