

Amphenol BACC 5015 Series Connectors



BOEING CERTIFIED 5015'S BRING HIGH PERFORMANCE TO UNIQUE AIRCRAFT CHALLENGES

BACC connectors are qualified to Boeing specifications to satisfy general-purpose requirements and unique product challenges for shielding, environmental sealing, fluid resistance, and vibration.

The Amphenol BACC 5015 series connectors use rear-release crimp contacts with a retention clip. These Amphenol connectors fill the gap between older MIL-DTL-5015s and the environmental and higher-performance demands of new technologies. They are sealed to withstand moisture, condensation, vibration and flash-over. Numerous layouts are available in arrangements that allow for just power, just signal, or a mix of both contact types. For more on the BACC 5015 series connectors including how to order, see the specifications details below.

CREATE PART NUMBER BACC63CD & CE

1	2A	3	2B	4	5	6
BACC63CE	18	-	4	P	W	H
SHELL STYLE	SHELL SIZE	CABLE CLAMP	LAYOUT	CONTACT	ROTATION	MODIFIER

WHEN CHOOSING LAYOUT

First Number = Step 2A – Shell Size, Dash = Step 3 – Cable Clamp, Second Number = 2B – Layout

STEP 1: SELECT SHELL STYLE, PLUG OR RECEPTACLE

PLUGS



BACC63CD

Front Mount Square Flange

Mates with

RECEPTACLES

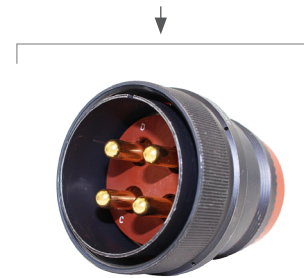

BACC63CE

Plug

STEP 2A & 2B: SELECT SHELL SIZE – LAYOUT

LAYOUT	TOTAL NUMBER	CONTACTS					ROTATIONS				SERVICE RATING
		16S	16	12	8	4	W	X	Y	Z	
12S-3	2	2					70	145	215	290	A
14S-2	4	4					-	120	240	-	I
14S-5	5	5					-	110	-	-	I
14S-7	3	3					90	180	270	-	A
18-4	4		4				35	110	250	325	D
20-4	4			4			45	110	250	-	D
22-2	3				3		70	145	215	290	D
22-22	4				4		-	110	250	-	A
24-9	2					2	35	110	250	325	A
24-10	7				7		80	-	-	280	A
24-11	9			6	3		35	110	250	325	A
24-22	4				4		45	110	250	-	D
28-22	6		3			3	70	145	215	290	D
32-17	4					4	45	110	250	-	D

STEP 3: SELECT CABLE CLAMP



- = No Cable Clamp

A = BACC10HV
Straight Cable Clamp

B = BACC10HW
Right Angle Cable Clamp

STEP 4: SELECT CONTACT



P = Pin **S** = Socket

STEP 5: SELECT ROTATION



See chart in steps 2A & 2B (omit for normal)

W, X, Y, Z

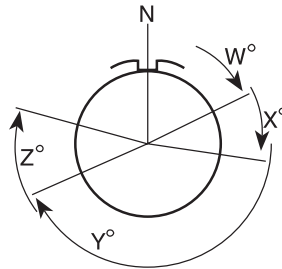

STEP 6: SELECT MODIFIER



H = Without contacts and Seal Plugs
Note: H is not marked on part

BLANK = With contacts and Seal Plugs

LAYOUTS BY NUMBER OF CONTACTS

CONTACT LEGEND ⊕ =16 ● =12 ⊙ =8 ○ =4 ⊗ =0
 Mating face view of pin inserts

LAYOUT
 # OF CONTACTS
 SERVICE RATING



12S-3
 2-#16S
 A



14S-2
 4-#16S
 I



14S-5
 5-#16S
 I

LAYOUT
 # OF CONTACTS
 SERVICE RATING



14S-7
 3-#16S
 A



18-4
 4-#16
 D

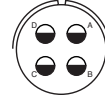

20-4
 4-#12
 D

LAYOUT
 # OF CONTACTS
 SERVICE RATING



22-2
 3-#8
 D

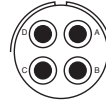

22-22
 4-#8
 A

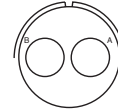

24-9
 2-#4
 A

LAYOUT
 # OF CONTACTS
 SERVICE RATING



24-10
 7-#8
 A

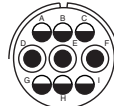

24-11
 6-#12, 3-#8
 A

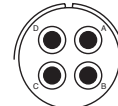

24-22
 4-#8
 D

LAYOUT
 # OF CONTACTS
 SERVICE RATING

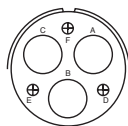

24-11
 6-#12, 3-#8
 A

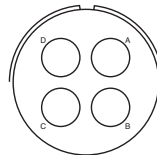

32-17
 4-#4
 D

BACC CABLE CLAMP ALUMINIUM - SELF LOCKING

BACC63CD
BACC63CE

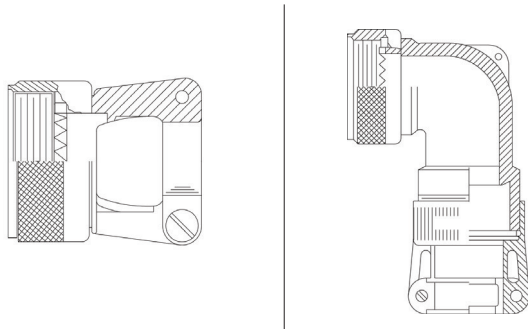

SHELL SIZE	SELF LOCKING CABLE CLAMP - ALUMINUM		CABLE RANGE	
	STRAIGHT	RIGHT ANGLE	MIN.	MAX.
8	BACC10HV08	BACC10HW08	0.125	0.204
10	BACC10HV10	BACC10HW10	0.187	0.286
12	BACC10HV12	BACC10HW12	0.291	0.416
14	BACC10HV14	BACC10HW14	0.351	0.476
16	BACC10HV16	BACC10HW16	0.501	0.626
18	BACC10HV18	BACC10HW18	0.518	0.706
20	BACC10HV20	BACC10HW20	0.581	0.831
22	BACC10HV22	BACC10HW22	0.644	0.956
24	BACC10HV24	BACC10HW24	0.706	1.081
28	BACC10HV28	BACC10HW28	0.750	1.187
32	BACC10HV32	BACC10HW32	0.875	1.250