



Figure similar

STARTER,FVNR,S0,3PH,THOLR,24VAC,N3R/4/12

product brand name	Siemens
product designation	Non-reversing motor starter
special product feature	No factory installed accessories
General technical data	
weight [lb]	15 lb
Height x Width x Depth [in]	12 × 10 × 6 in
touch protection against electrical shock	NA for enclosed products
installation altitude [ft] at height above sea level maximum	6 560 ft
ambient temperature [°F] during storage	-22 ... +149 °F
ambient temperature [°F] during operation	-4 ... +104 °F
ambient temperature during storage	-30 ... +65 °C
ambient temperature during operation	-20 ... +40 °C
country of origin	Germany
Power and control electronics	
number of poles for main current circuit	3
type of voltage of the control supply voltage	AC
control supply voltage	
• at AC at 50 Hz rated value	24 V
• at AC at 60 Hz rated value	24 V
disconnecter functionality	No
yielded mechanical performance [hp] for 3-phase AC motor	
• at 200/208 V rated value	10 hp
• at 220/230 V rated value	10 hp
• at 460/480 V rated value	25 hp
• at 575/600 V rated value	25 hp
Contactors	
number of NO contacts for main contacts	3
operating voltage for main current circuit at AC at 60 Hz maximum	600 V
operating voltage at AC-3 rated value maximum	600 V
mechanical service life (switching cycles) of the main contacts typical	10 000 000
Auxiliary contact	
number of NC contacts for auxiliary contacts	1
number of NO contacts for auxiliary contacts	1
number of total auxiliary contacts maximum	8
contact rating of auxiliary contacts of contactor according to UL	10A@600V(A600), 2.5A@600V(Q600)

Coil	
apparent pick-up power of magnet coil at AC	79 V·A
apparent holding power of magnet coil at AC	8.5 V·A
operating range factor control supply voltage rated value of magnet coil	0.8 ... 1.1
ON-delay time	8 ... 40 ms
OFF-delay time	4 ... 16 ms
Overload relay	
product function	
• overload protection	Yes
• test function	Yes
• external reset	Yes
reset function	Manual, automatic and remote (with optional accessory)
adjustment range of thermal overload trip unit	30 ... 36
number of NC contacts of auxiliary contacts of overload relay	1
number of NO contacts of auxiliary contacts of overload relay	1
contact rating of auxiliary contacts of overload relay according to UL	5A@600VAC (B600), 1A@250VDC (R300)
Enclosure	
degree of protection NEMA rating of the enclosure	NEMA 3/3R/4/12 enclosure
design of the housing	Dust- & watertight for outdoor use
Mounting/wiring	
mounting position	vertical
fastening method	Surface mounting and installation
type of electrical connection for supply voltage line-side	Screw-type terminals
tightening torque [lbf·in] for supply	18 ... 21 lbf·in
type of connectable conductor cross-sections at line-side at AWG cables single or multi-stranded	2x (16 ... 12), 2x (14 ... 8)
temperature of the conductor for supply maximum permissible	60 °C
material of the conductor for supply	CU
type of electrical connection for load-side outgoing feeder	Screw-type terminals
tightening torque [lbf·in] for load-side outgoing feeder	18 ... 21 lbf·in
type of connectable conductor cross-sections at AWG cables for load-side outgoing feeder single or multi-stranded	2x (16 ... 12), 2x (14 ... 8)
temperature of the conductor for load-side outgoing feeder maximum permissible	60 °C
material of the conductor for load-side outgoing feeder	CU
type of electrical connection of magnet coil	Screw-type terminals
tightening torque [lbf·in] at magnet coil	7 ... 10 lbf·in
type of connectable conductor cross-sections of magnet coil at AWG cables single or multi-stranded	2x (16 ... 12), 2x (14 ... 8)
temperature of the conductor at magnet coil maximum permissible	75 °C
material of the conductor at magnet coil	CU
type of electrical connection for auxiliary contacts	Screw-type terminals
tightening torque [lbf·in] at contactor for auxiliary contacts	7 ... 10 lbf·in
type of connectable conductor cross-sections at contactor at AWG cables for auxiliary contacts single or multi-stranded	2x (20 ... 16), 2x (18 ... 14)
temperature of the conductor at contactor for auxiliary contacts maximum permissible	75 °C
material of the conductor at contactor for auxiliary contacts	CU
type of electrical connection at overload relay for auxiliary contacts	Screw-type terminals
tightening torque [lbf·in] at overload relay for auxiliary contacts	7 ... 10 lbf·in
type of connectable conductor cross-sections at overload relay at AWG cables for auxiliary contacts single or multi-stranded	2x (20 ... 16), 2x (18 ... 14)
temperature of the conductor at overload relay for auxiliary	70 °C

contacts maximum permissible	
material of the conductor at overload relay for auxiliary contacts	CU
Short-circuit current rating	
design of the fuse link for short-circuit protection of the main circuit required	Class J
design of the short-circuit trip	Thermal magnetic circuit breaker
breaking capacity maximum short-circuit current (Icu)	
• at 240 V	5 kA
• at 480 V	5 kA
• at 600 V	5 kA
certificate of suitability	UL 60947-4-1
Further information	

Industrial Controls - Product Overview (Catalogs, Brochures,...)

www.usa.siemens.com/iccatalog

Industry Mall (Online ordering system)

<https://mall.industry.siemens.com/mall/en/us/Catalog/product?mlfb=3RE4122-8CA11-4PY0>

Search Datasheet in Service&Support (Manuals)

<https://support.industry.siemens.com/cs/US/en/ps/3RE4122-8CA11-4PY0/man>

Image database (product images, 2D dimension drawings, 3D models, device circuit diagrams, EPLAN macros, ...)

http://www.automation.siemens.com/bilddb/cax_de.aspx?mlfb=3RE4122-8CA11-4PY0&lang=en

Certificates/approvals

<https://support.industry.siemens.com/cs/US/en/ps/3RE4122-8CA11-4PY0/certificate>

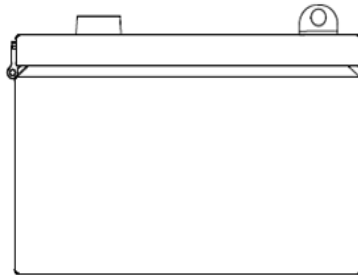
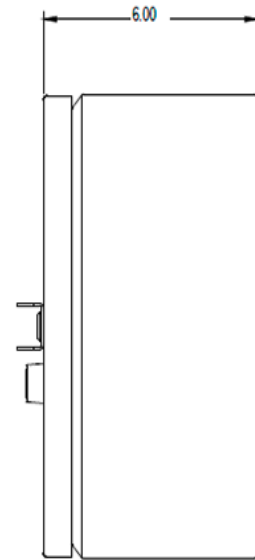
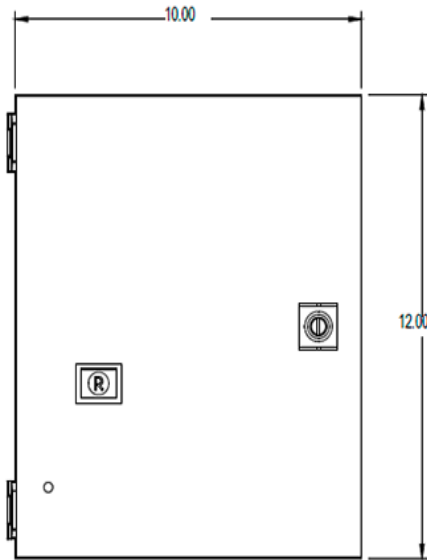
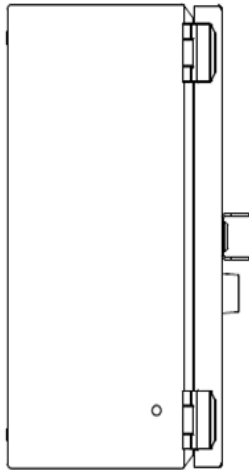
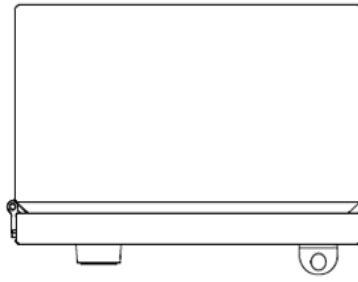

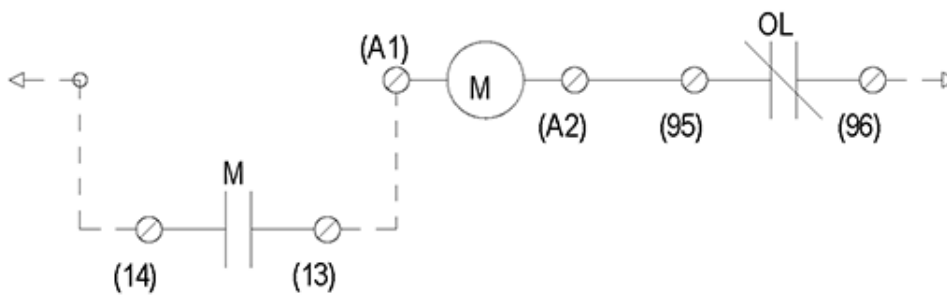
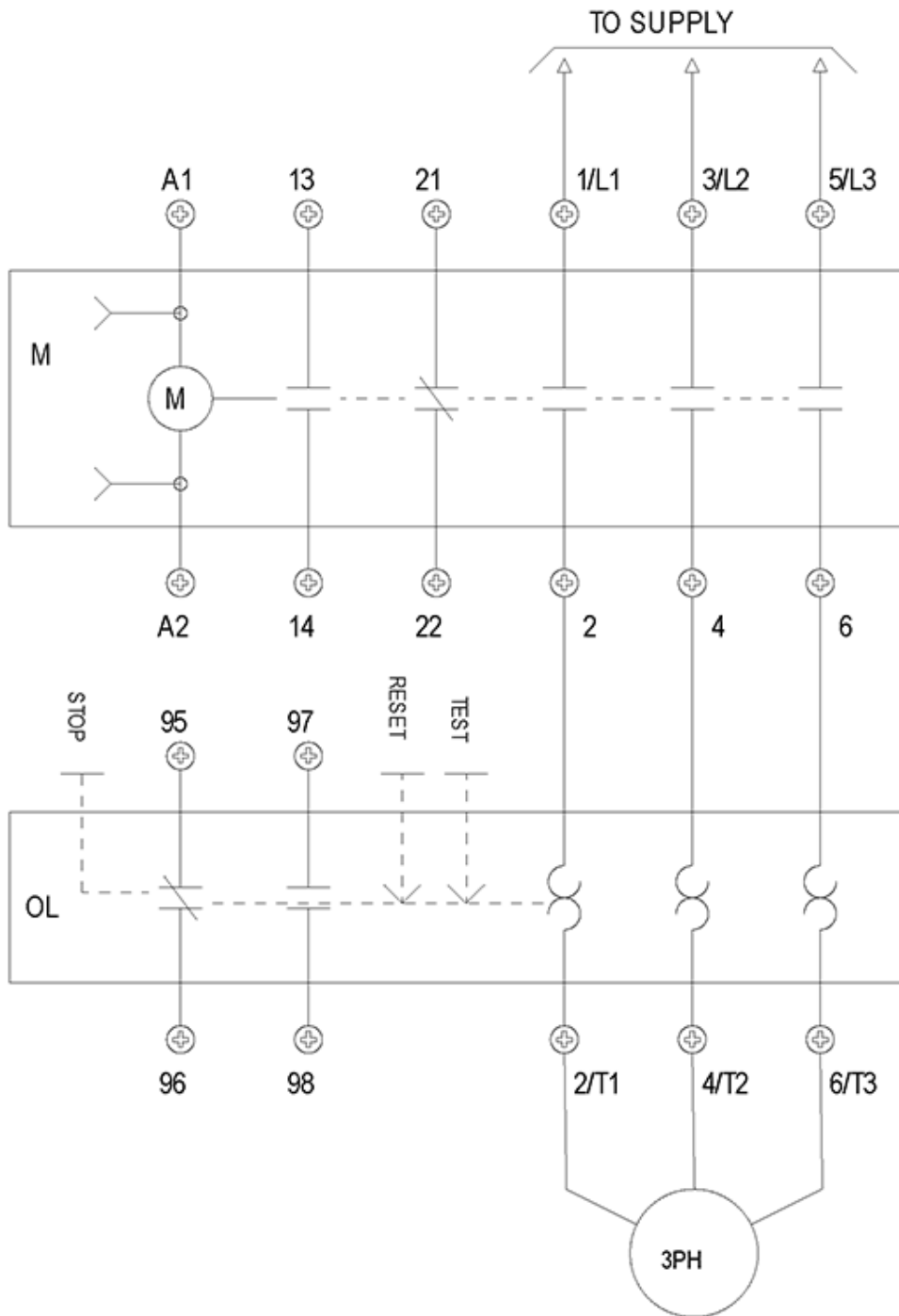

last modified:

4/15/2021