

Product Summary

PPK	V _{RWM}	PM _(AV)
3000W	5V to 170V	5W

Features and Benefits

- 3000W Peak Pulse Power Dissipation
- 5V to 170V Standoff Voltages
- Unidirectional and Bidirectional
- Glass Passivated Die Construction
- Excellent Clamping Capability
- **Lead-Free Finish; RoHS Compliant (Notes 1 & 2)**
- **Halogen and Antimony Free. “Green” Device (Note 3)**
- **For automotive applications requiring specific change control (i.e.: parts qualified to AEC-Q100/101/104/200, PPAP capable, and manufactured in IATF 16949 certified facilities), please refer to the related automotive grade (Q-suffix) part. A listing can be found at <https://www.diodes.com/products/automotive/automotive-products/>.**
- **This part is qualified to JEDEC standards (as references in AEC-Q) for High Reliability. <https://www.diodes.com/quality/product-definitions/>**

Mechanical Data

- Package: SMC
- Package Material: Molded Plastic.
UL Flammability Classification Rating 94V-0
- Moisture Sensitivity: Level 1 per J-STD-020
- Terminals: Finish—Matte Tin Plated Leads
Solderable per MIL-STD-202, Method 208 ^(e3)
- Unidirectional Devices Have A Cathode Band. Bidirectional Devices Have No Polarity Indicator
- Weight: 0.21 grams (Approximate)

SMC

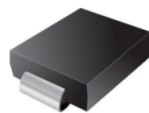

Top View



Bottom View

Ordering Information (Note 4)

Part Number	Qualification	Package	Packing	
			Qty.	Carrier
3.0SMCJX.X(C)A-13*	Commercial	SMC	3000pcs	Tape & Reel
3.0SMCJXX(C)A-13*	Commercial	SMC	3000pcs	Tape & Reel
3.0SMCJXXX(C)A-13*	Commercial	SMC	3000pcs	Tape & Reel

*X = Device Voltage, e.g., 3.0SMCJ14CA-13.

- Notes:
1. EU Directive 2002/95/EC (RoHS), 2011/65/EU (RoHS 2) & 2015/863/EU (RoHS 3) compliant. All applicable RoHS exemptions applied.
 2. See <https://www.diodes.com/quality/lead-free/> for more information about Diodes Incorporated's definitions of Halogen- and Antimony-free, "Green" and Lead-free.
 3. Halogen- and Antimony-free "Green" products are defined as those which contain <900ppm bromine, <900ppm chlorine (<1500ppm total Br + Cl) and <1000ppm antimony compounds.
 4. For packaging details, go to our website at <https://www.diodes.com/design/support/packaging/diodes-packaging/>.

Marking Information

Cathode Band for Uni-Directional Device



Bi-Directional Device

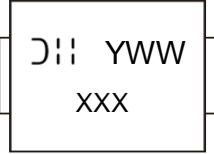

XXX = Product Type Marking Code
(See Electrical Characteristics Table)
D:: = Manufacturer's Marking
YWW = Date Code Marking
Y = Last Digit of Year (ex: 2 for 2022)
WW = Week Code (01 to 53)

Maximum Ratings (@T_A = +25°C, unless otherwise specified.)

Single phase, half wave, 60Hz, resistive or inductive load.
For capacitive load, derate current by 20%.

Characteristic	Symbol	Value	Unit
Peak Pulse Power Dissipation (Note 5)	PPK	3000	W
Peak Forward Surge Current, 8.3ms Single Half Sine Wave Superimposed on Rated Load (Notes 6, 7 & 8)	IFSM	300	A

- Notes:
5. Non-repetitive current pulse per Fig. 4 and derated above T_A = +25°C per Fig. 1.
 6. Mounted on 8.00mm² (0.013mm thick) land areas.
 7. Measured with 8.3ms single half sine-wave. Duty cycle = 4 pulses per minute maximum.
 8. Unidirectional units only.

Thermal Characteristics

Characteristic	Symbol	Value	Unit
Operating Temperature Range	T _J	-55 to +150	°C
Storage Temperature Range	T _{STG}	-55 to +150	°C

Electrical Characteristics (@T_A = +25°C, unless otherwise specified.)

Part Number	Reverse Standoff Voltage	Breakdown Voltage V _{BR} @ I _T (Note 10)		Test Current	Max. Reverse Leakage @ V _{RWM} (Note 11)	Max. Clamping Voltage @ I _{PP} (Note 9)	Max. Peak Pulse Current	Marking Code	
	V _{RWM} (V)	Min (V)	Max (V)	I _T (mA)	I _R (μA)	V _C (V)	I _{PP} (A)	Un-	Bi-
3.0SMCJ5.0(C)A	5.0	6.40	7.07	10	1000	9.2	326.1	HDE	DHS
3.0SMCJ6.0(C)A	6.0	6.67	7.37	10	1000	10.3	291.3	HDG	DDG
3.0SMCJ6.5(C)A	6.5	7.22	7.98	10	500	11.2	267.9	HDK	DHV
3.0SMCJ7.0(C)A	7.0	7.78	8.60	10	200	12.0	250.0	HDM	DHW
3.0SMCJ7.5(C)A	7.5	8.33	9.21	1.0	100	12.9	232.6	HDP	DDP
3.0SMCJ8.0(C)A	8.0	8.89	9.83	1.0	50	13.6	220.6	HDR	DDR
3.0SMCJ8.5(C)A	8.5	9.44	10.43	1.0	25	14.4	208.3	HDT	DDT
3.0SMCJ9.0(C)A	9.0	10.00	11.05	1.0	10	15.4	194.8	HDV	DDV
3.0SMCJ10(C)A	10.0	11.10	12.27	1.0	5.0	17.0	176.5	HDX	DDX
3.0SMCJ11(C)A	11.0	12.20	13.5	1.0	5.0	18.2	164.8	HDZ	DDZ
3.0SMCJ12(C)A	12.0	13.30	14.7	1.0	5.0	19.9	150.8	HEE	DEE
3.0SMCJ13(C)A	13.0	14.40	15.9	1.0	5.0	21.5	139.5	HEG	DED
3.0SMCJ14(C)A	14.0	15.60	17.2	1.0	5.0	23.2	129.3	HEK	DEK
3.0SMCJ15(C)A	15.0	16.70	18.5	1.0	5.0	24.2	124.0	HEM	DEM
3.0SMCJ16(C)A	16.0	17.80	19.7	1.0	5.0	26.0	115.4	HEP	DEP
3.0SMCJ17(C)A	17.0	18.90	20.9	1.0	5.0	27.6	108.7	HER	DER
3.0SMCJ18(C)A	18.0	20.00	22.1	1.0	5.0	29.2	102.7	HET	DET
3.0SMCJ20(C)A	20.0	22.20	24.5	1.0	5.0	32.4	92.6	HEV	DEV
3.0SMCJ22(C)A	22.0	24.40	27.0	1.0	5.0	35.5	84.5	HEX	DEX
3.0SMCJ24(C)A	24.0	26.70	29.5	1.0	5.0	38.9	77.1	HEZ	DEZ
3.0SMCJ26(C)A	26.0	28.90	31.9	1.0	5.0	42.1	71.3	HFE	DFE
3.0SMCJ28(C)A	28.0	31.10	34.4	1.0	5.0	45.4	66.1	HFG	DFD
3.0SMCJ30(C)A	30.0	33.30	36.8	1.0	5.0	48.4	62.0	HFK	DFK
3.0SMCJ33(C)A	33.0	36.70	40.6	1.0	5.0	53.3	56.3	HFM	DFM
3.0SMCJ36(C)A	36.0	40.00	44.2	1.0	5.0	58.1	51.6	HFP	DFP
3.0SMCJ40(C)A	40.0	44.40	49.1	1.0	5.0	64.5	46.5	HFR	DFR
3.0SMCJ43(C)A	43.0	47.80	52.8	1.0	5.0	69.4	43.2	HFT	DFT
3.0SMCJ45(C)A	45.0	50.00	55.3	1.0	5.0	72.7	41.3	HFV	DFV
3.0SMCJ48(C)A	48.0	53.30	58.9	1.0	5.0	77.4	38.8	HFV	DFV
3.0SMCJ51(C)A	51.0	56.70	62.7	1.0	5.0	82.4	36.4	HFZ	DFZ
3.0SMCJ54(C)A	54.0	60.00	66.3	1.0	5.0	87.1	34.4	HGE	DDE
3.0SMCJ58(C)A	58.0	64.40	71.2	1.0	5.0	93.6	32.1	HGG	DDD
3.0SMCJ60(C)A	60.0	66.70	73.7	1.0	5.0	96.8	31.0	HGK	DDK
3.0SMCJ64(C)A	64.0	71.10	78.6	1.0	5.0	103.0	29.1	HGM	DDM
3.0SMCJ70(C)A	70.0	77.80	86.0	1.0	5.0	113.0	26.5	HGP	DGP
3.0SMCJ75(C)A	75.0	83.30	92.1	1.0	5.0	121.0	24.8	HGR	DGR
3.0SMCJ78(C)A	78.0	86.70	95.8	1.0	5.0	126.0	23.8	HGT	DGT
3.0SMCJ85(C)A	85.0	94.40	104.3	1.0	5.0	137.0	21.9	HGV	DGV
3.0SMCJ90(C)A	90.0	100.00	110.5	1.0	5.0	146.0	20.5	HGX	DGX
3.0SMCJ100(C)A	100.0	111.00	122.7	1.0	5.0	162.0	18.5	HGZ	DGZ
3.0SMCJ110(C)A	110.0	122.00	134.8	1.0	5.0	177.0	16.9	HHE	DHE
3.0SMCJ120(C)A	120.0	133.00	147.0	1.0	5.0	193.0	15.5	HHG	DHG
3.0SMCJ130(C)A	130.0	144.00	159.2	1.0	5.0	209.0	14.4	HHK	DHK
3.0SMCJ150(C)A	150.0	167.00	184.6	1.0	5.0	243.0	12.3	HHM	DGM
3.0SMCJ160(C)A	160.0	178.00	196.7	1.0	5.0	259.0	11.6	HHP	DHP
3.0SMCJ170(C)A	170.0	189.00	208.9	1.0	5.0	275.0	10.9	HHR	DHR

Notes: 9. Per 10 x 1000μs waveform. See Fig. 2.
10. V_{BR} measured with I_T current pulse = 10ms to 15ms.
11. The I_R limit is double for Bi-Directional device for V_B ≤ 10V.

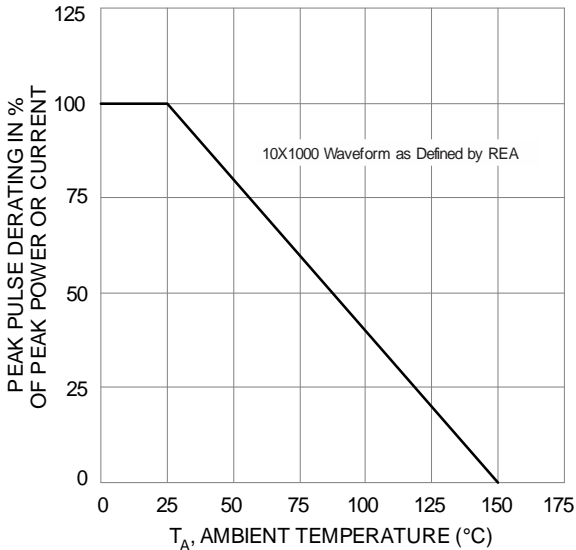

Fig. 1 Pulse Derating Curve

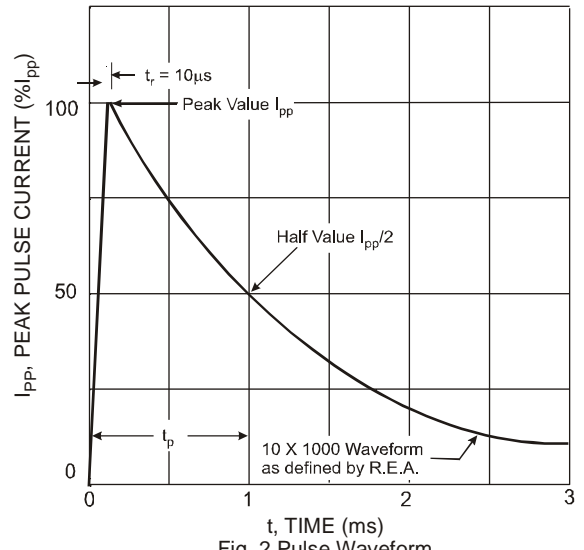

Fig. 2 Pulse Waveform

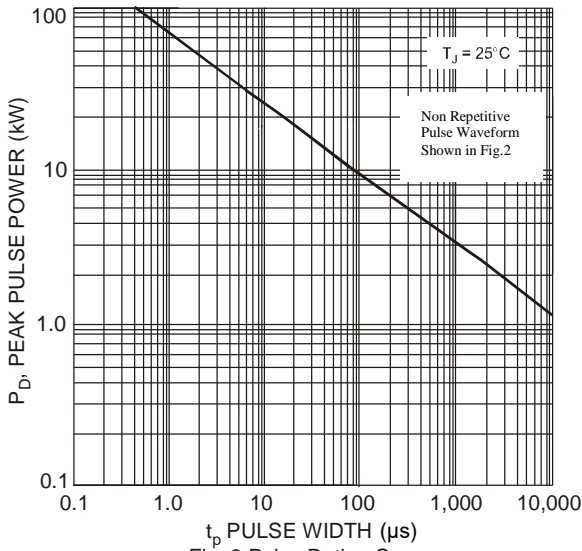

Fig. 3 Pulse Rating Curve

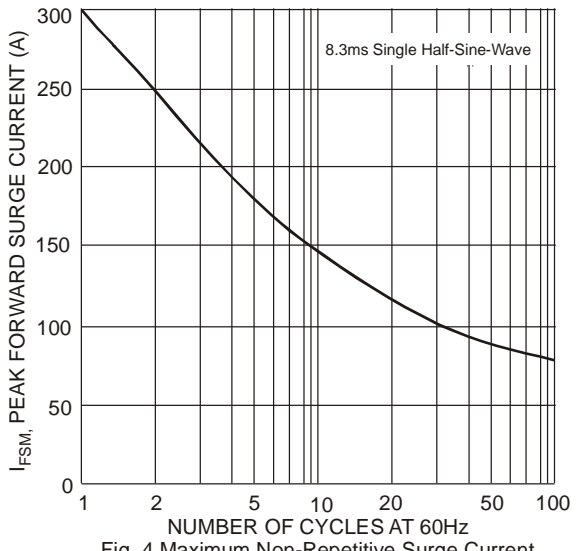
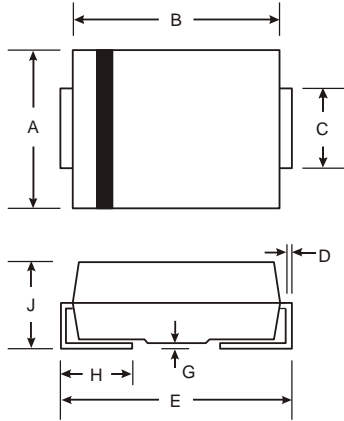

Fig. 4 Maximum Non-Repetitive Surge Current

Package Outline Dimensions

Please see <http://www.diodes.com/package-outlines.html> for the latest version.

SMC



SMC		
Dim	Min	Max
A	5.59	6.22
B	6.60	7.11
C	2.75	3.18
D	0.15	0.31
E	7.75	8.13
G	0.10	0.20
H	0.76	1.52
J	2.00	2.50
All Dimensions in mm		

Suggested Pad Layout

Please see <http://www.diodes.com/package-outlines.html> for the latest version.

SMC

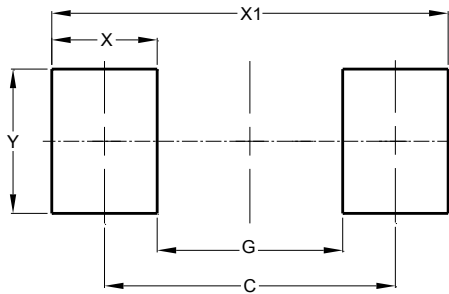

Dimensions	Value (in mm)
C	6.90
G	4.40
X	2.50
X1	9.40
Y	3.30

IMPORTANT NOTICE

1. DIODES INCORPORATED AND ITS SUBSIDIARIES (“DIODES”) MAKE NO WARRANTY OF ANY KIND, EXPRESS OR IMPLIED, WITH REGARDS TO ANY INFORMATION CONTAINED IN THIS DOCUMENT, INCLUDING, BUT NOT LIMITED TO, THE IMPLIED WARRANTIES OF MERCHANTABILITY, FITNESS FOR A PARTICULAR PURPOSE OR NON-INFRINGEMENT OF THIRD PARTY INTELLECTUAL PROPERTY RIGHTS (AND THEIR EQUIVALENTS UNDER THE LAWS OF ANY JURISDICTION).
2. The Information contained herein is for informational purpose only and is provided only to illustrate the operation of Diodes products described herein and application examples. Diodes does not assume any liability arising out of the application or use of this document or any product described herein. This document is intended for skilled and technically trained engineering customers and users who design with Diodes products. Diodes products may be used to facilitate safety-related applications; however, in all instances customers and users are responsible for (a) selecting the appropriate Diodes products for their applications, (b) evaluating the suitability of the Diodes products for their intended applications, (c) ensuring their applications, which incorporate Diodes products, comply the applicable legal and regulatory requirements as well as safety and functional-safety related standards, and (d) ensuring they design with appropriate safeguards (including testing, validation, quality control techniques, redundancy, malfunction prevention, and appropriate treatment for aging degradation) to minimize the risks associated with their applications.
3. Diodes assumes no liability for any application-related information, support, assistance or feedback that may be provided by Diodes from time to time. Any customer or user of this document or products described herein will assume all risks and liabilities associated with such use, and will hold Diodes and all companies whose products are represented herein or on Diodes’ websites, harmless against all damages and liabilities.
4. Products described herein may be covered by one or more United States, international or foreign patents and pending patent applications. Product names and markings noted herein may also be covered by one or more United States, international or foreign trademarks and trademark applications. Diodes does not convey any license under any of its intellectual property rights or the rights of any third parties (including third parties whose products and services may be described in this document or on Diodes’ website) under this document.
5. Diodes products are provided subject to Diodes’ Standard Terms and Conditions of Sale (<https://www.diodes.com/about/company/terms-and-conditions/terms-and-conditions-of-sales/>) or other applicable terms. This document does not alter or expand the applicable warranties provided by Diodes. Diodes does not warrant or accept any liability whatsoever in respect of any products purchased through unauthorized sales channel.
6. Diodes products and technology may not be used for or incorporated into any products or systems whose manufacture, use or sale is prohibited under any applicable laws and regulations. Should customers or users use Diodes products in contravention of any applicable laws or regulations, or for any unintended or unauthorized application, customers and users will (a) be solely responsible for any damages, losses or penalties arising in connection therewith or as a result thereof, and (b) indemnify and hold Diodes and its representatives and agents harmless against any and all claims, damages, expenses, and attorney fees arising out of, directly or indirectly, any claim relating to any noncompliance with the applicable laws and regulations, as well as any unintended or unauthorized application.
7. While efforts have been made to ensure the information contained in this document is accurate, complete and current, it may contain technical inaccuracies, omissions and typographical errors. Diodes does not warrant that information contained in this document is error-free and Diodes is under no obligation to update or otherwise correct this information. Notwithstanding the foregoing, Diodes reserves the right to make modifications, enhancements, improvements, corrections or other changes without further notice to this document and any product described herein. This document is written in English but may be translated into multiple languages for reference. Only the English version of this document is the final and determinative format released by Diodes.
8. Any unauthorized copying, modification, distribution, transmission, display or other use of this document (or any portion hereof) is prohibited. Diodes assumes no responsibility for any losses incurred by the customers or users or any third parties arising from any such unauthorized use.

Copyright © 2022 Diodes Incorporated

www.diodes.com