

**MPS 5/04 S F2 TN B B****Weidmüller Interface GmbH & Co. KG**

Klingenbergstraße 26

D-32758 Detmold

Germany

www.weidmueller.com

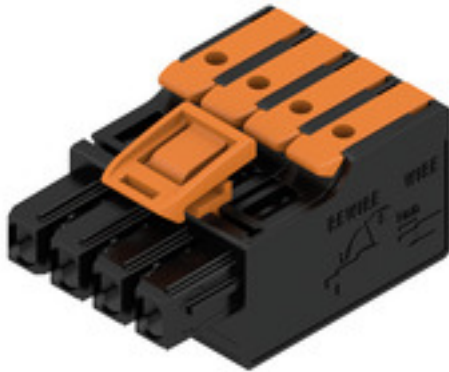
**Product image****General ordering data**

|              |   |
|--------------|---|
| Order No.    | <a href="#">2741690000</a>  |
| Type         | MPS 5/04 S F2 TN B B  |
| GTIN (EAN)   | 4064675055211   |
| Qty.         | 84 pc(s).   |
| Product data | IEC: 400 V / 26.8 A / 0.5 - 2.5 mm² UL: 300 V / 18.5 A / AWG 20 - AWG 12/7, AWG12/9 |
| Packaging    | Box   |

Creation date December 21, 2020 5:09:38 PM CET

Catalogue status 08.12.2020 / We reserve the right to make technical changes.

## MPS 5/04 S F2 TN B B

Weidmüller Interface GmbH &amp; Co. KG

Klingenbergstraße 26

D-32758 Detmold

Germany

www.weidmueller.com

## Technical data

## Dimensions and weights

|            |             |                 |            |
|------------|-------------|-----------------|------------|
| Depth      | 34 mm       | Depth (inches)  | 1.339 inch |
| Height     | 17.5 mm     | Height (inches) | 0.689 inch |
| Net weight | 2,025.574 g | Weight          | 9.23 g     |
| Width      | 20.8 mm     | Width (inches)  | 0.819 inch |

## System Parameters

|  |                        |       |  |
|--|------------------------|-------|--|
| Type of connection                           | Field connection       |       |  |
| Wire connection method                       | SNAP IN                |       |  |
| Pitch in mm (P)                              | 5 mm                   |       |  |
| Pitch in inches (P)                          | 0.197 inch             |       |  |
| Conductor outlet direction                   | 180°                   |       |  |
| Number of poles                              | 4                      |       |  |
| Number of rows                               | 1                      |       |  |
| Pin series quantity                          | 1                      |       |  |
| Touch-safe protection acc. to DIN VDE 57 106 | Safe from finger touch |       |  |
| Touch-safe protection acc. to DIN VDE 0470   | IP 20                  |       |  |
| Volume resistance                            | ≤5 mΩ                  |       |  |
| Stripping length                             | 9 mm                   |       |  |
| Stripping length tolerance                   | min.                   | 8 mm  |  |
|  | max.                   | 10 mm |  |
| Plugging force/pole, max.                    | 8.5 N                  |       |  |
| Pulling force/pole, max.                     | 8.5 N                  |       |  |

## Material data

|                                  |             |                             |        |
|----------------------------------|-------------|-----------------------------|--------|
| Insulating material              | PBT GF      | Colour                      | black  |
| Colour chart (similar)           | RAL 9011    | Insulating material group   | I      |
| Comparative Tracking Index (CTI) | ≥ 600       | UL 94 flammability rating   | V-0    |
| Contact material                 | CuSn        | Contact surface             | tinned |
| Layer structure of plug contact  | 4...8 μm Sn | Storage temperature, min.   | -25 °C |
| Storage temperature, max.        | 55 °C       | Operating temperature, min. | -50 °C |
| Operating temperature, max.      | 100 °C      |                             |        |

## Conductors suitable for connection

|   |                     |
|---|---------------------|
| Clamping range, min.  | 0.5 mm <sup>2</sup> |
| Clamping range, max.  | 2.5 mm <sup>2</sup> |
| Wire connection cross section AWG, min.                             | AWG 20              |
| Wire connection cross section AWG, max.                             | AWG 14              |
| Solid, min. H05(07) V-U   | 0.5 mm <sup>2</sup> |
| Solid, max. H05(07) V-U   | 2.5 mm <sup>2</sup> |
| Flexible, min. H05(07) V-K  | 0.5 mm <sup>2</sup> |
| Flexible, max. H05(07) V-K  | 2.5 mm <sup>2</sup> |
| w. plastic collar ferrule, DIN 46228 pt 4, 0.5 mm <sup>2</sup> min. |                     |
| w. plastic collar ferrule, DIN 46228 pt 4, 2.5 mm <sup>2</sup> max. |                     |
| w. wire end ferrule, DIN 46228 pt 1, min.                           | 0.5 mm <sup>2</sup> |
| w. wire end ferrule, DIN 46228 pt 1, max.                           | 2.5 mm <sup>2</sup> |

Creation date December 21, 2020 5:09:38 PM CET

## MPS 5/04 S F2 TN B B

**Weidmüller Interface GmbH & Co. KG**  
 Klingenbergstraße 26  
 D-32758 Detmold  
 Germany

www.weidmueller.com

## Technical data

|  |  |                              |                            |
|--|--|------------------------------|----------------------------|
| Outer diameter of insulation, max.     | 4 mm                                   |                              |                            |
| Clampable conductor                    | Cross-section for conductor connection | nominal                      | 0.5 mm <sup>2</sup>        |
|  | wire end ferrule                       | Stripping length             | nominal 12 mm              |
|  |  | Recommended wire-end ferrule | <a href="#">H0.5/16 OR</a> |
|  |  | Stripping length             | nominal 10 mm              |
|  |  | Recommended wire-end ferrule | <a href="#">H0.5/10</a>    |
|  | Cross-section for conductor connection | nominal                      | 0.75 mm <sup>2</sup>       |
|  | wire end ferrule                       | Stripping length             | nominal 12 mm              |
|  |  | Recommended wire-end ferrule | <a href="#">H0.75/16 W</a> |
|  |  | Stripping length             | nominal 10 mm              |
|  |  | Recommended wire-end ferrule | <a href="#">H0.75/10</a>   |
|  | Cross-section for conductor connection | nominal                      | 1 mm <sup>2</sup>          |
|  | wire end ferrule                       | Stripping length             | nominal 12 mm              |
|  |  | Recommended wire-end ferrule | <a href="#">H1.0/16 GE</a> |
|  |  | Stripping length             | nominal 10 mm              |
|  |  | Recommended wire-end ferrule | <a href="#">H1.0/10</a>    |
|  | Cross-section for conductor connection | nominal                      | 1.5 mm <sup>2</sup>        |
|  | wire end ferrule                       | Stripping length             | nominal 12 mm              |
|  |  | Recommended wire-end ferrule | <a href="#">H1.5/16 R</a>  |
|  |  | Stripping length             | nominal 10 mm              |
|  |  | Recommended wire-end ferrule | <a href="#">H1.5/10</a>    |
| Cross-section for conductor connection | nominal                                | 2.5 mm <sup>2</sup>          |                            |
| wire end ferrule                       | Stripping length                       | nominal 10 mm                |                            |
|  | Recommended wire-end ferrule           | <a href="#">H2.5/15D BL</a>  |                            |
|  | Stripping length                       | nominal 10 mm                |                            |
|  | Recommended wire-end ferrule           | <a href="#">H2.5/10</a>      |                            |

Reference text The outside diameter of the plastic collar should not be larger than the pitch (P). Length of ferrules is to be chosen depending on the product and the rated voltage.

### Rated data acc. to IEC

|   |                        |  |
|---|------------------------|--|
| tested acc. to standard   | IEC 60664-1, IEC 61984 |  |
| Rated current, max. number of poles (Tu=20°C)                             | 19.7 A                 | Rated current, min. number of poles (Tu=20°C) 26.8 A                       |
| Rated current, max. number of poles (Tu=40°C)                             | 16.9 A                 | Rated current, min. number of poles (Tu=40°C) 23.1 A                       |
| Rated voltage for surge voltage class / pollution degree III/2            | 320 V                  | Rated voltage for surge voltage class / pollution degree II/2 400 V        |
| Rated impulse voltage for surge voltage class/ pollution degree II/2      | 4 kV                   | Rated voltage for surge voltage class / pollution degree III/3 250 V       |
| Rated impulse voltage for surge voltage class/ contamination degree III/3 | 4 kV                   | Rated impulse voltage for surge voltage class/ pollution degree III/2 4 kV |

**Data sheet**

**MPS 5/04 S F2 TN B B**

**Weidmüller Interface GmbH & Co. KG**  
 Klingenbergstraße 26  
 D-32758 Detmold  
 Germany

www.weidmueller.com

**Technical data**

**Rated data acc. to UL 1059**

|                                       |   |                                       |        |
|---------------------------------------|---|---------------------------------------|--------|
| Institute (cURus)                     |  | Certificate No. (cURus)               | E60693 |
| Rated voltage (Use group B / UL 1059) | 300 V   | Rated voltage (Use group D / UL 1059) | 300 V  |
| Rated current (Use group B / UL 1059) | 18.5 A  | Rated current (Use group D / UL 1059) | 10 A   |
| Wire cross-section, AWG, min.         | AWG 18  | Wire cross-section, AWG, max.         | AWG 14 |
| Reference to approval values          | Specifications are maximum values, details - see approval certificate.            |                                       |        |

**Classifications**

|             |             |             |             |
|-------------|-------------|-------------|-------------|
| ETIM 6.0    | EC002638    | ETIM 7.0    | EC002638    |
| ECLASS 9.0  | 27-44-03-09 | ECLASS 9.1  | 27-44-03-09 |
| ECLASS 10.0 | 27-44-03-09 | ECLASS 11.0 | 27-46-02-02 |

**Important note**

|                |  |
|----------------|--|
| IPC conformity | Conformity: The products are developed, manufactured and delivered according international recognized standards and norms and comply with the assured properties in the data sheet resp. fulfill decorative properties in accordance with IPC-A-610 "Class 2". Further claims on the products can be evaluated on request.   |
| Notes          | <ul style="list-style-type: none"> <li>• Rated current related to rated cross-section &amp; min. No. of poles.</li> <li>• P on drawing = pitch</li> <li>• Rated data refer only to the component itself. Clearance and creepage distances to other components are to be designed in accordance with the relevant application standards.</li> <li>• Wire end ferrule without plastic collar to DIN 46228/1</li> </ul> |

**Approvals**

|                       |   |
|-----------------------|---|
| Approvals             |  |
| UL File Number Search | E60693  |

**Downloads**

|                  |                      |
|------------------|----------------------|
| Engineering Data | <a href="#">STEP</a> |
|------------------|----------------------|

**MPS 5/04 S F2 TN B B**

**Weidmüller Interface GmbH & Co. KG**  
 Klingenbergstraße 26  
 D-32758 Detmold  
 Germany

www.weidmueller.com

Drawings

Product image

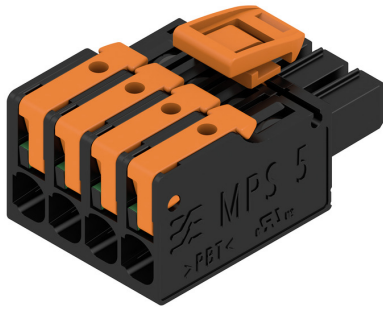

Dimensional drawing

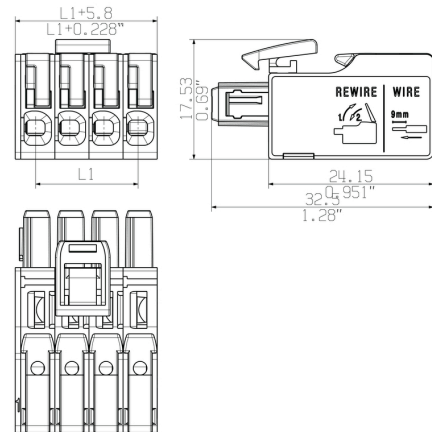

Derating curve

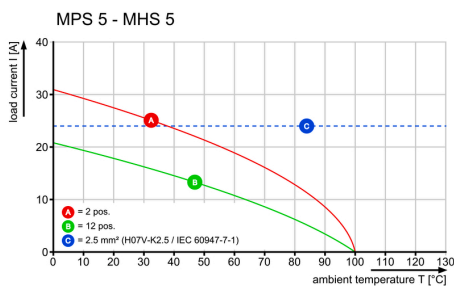

Product benefits



Fastest connection technology SNAP IN

Product benefits



Acoustic and visual feedback

Product benefits

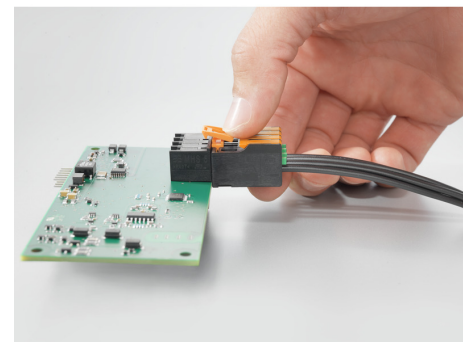

Easy one-handed use of top-fixation

**MPS 5/04 S F2 TN B B**

**Weidmüller Interface GmbH & Co. KG**  
 Klingenbergstraße 26  
 D-32758 Detmold  
 Germany

www.weidmueller.com

**Mating connector (fully pluggable)**

**Standard**

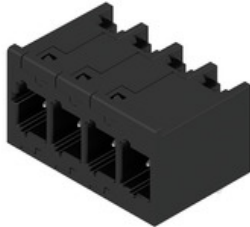

Configurable connector portfolio with fast and safe SNAP IN connection technology. The modular slice concept allows different hybrid combinations out of signal, data and power in one. The future-proof system is suitable for the highest requirements of the digital and connected world.

**General ordering data**

|            |                            | Product data                           | Packaging |
|------------|----------------------------|--|-----------|
| Type       | MHS 5/04 H T3 B T          | IEC: 400 V / 26.8 A UL: 300 V / 18.5 A | Tube      |
| Order No.  | <a href="#">2741430000</a> |  |           |
| GTIN (EAN) | 4064675055402              |  |           |
| Qty.       | 25 pc(s).                  |  |           |

Allgemeinguetlige Kundenzeichnung, aktueller Stand nur auf Anfrage  
 General customer drawing, topical version only if required

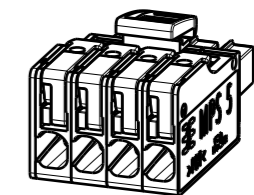
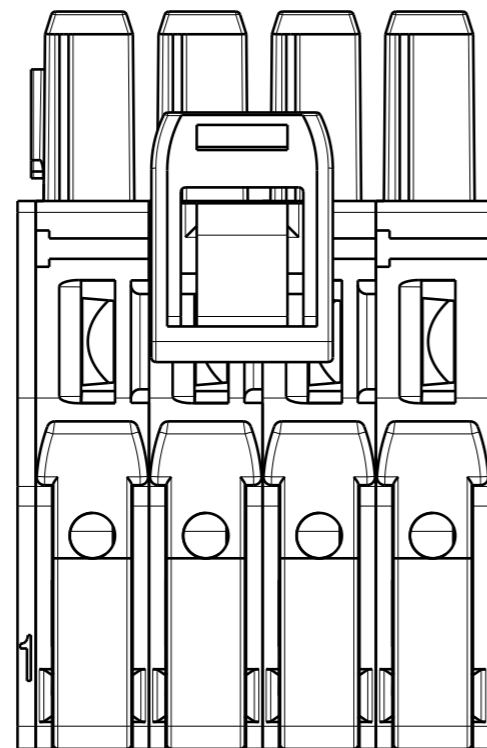
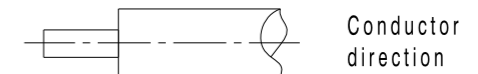
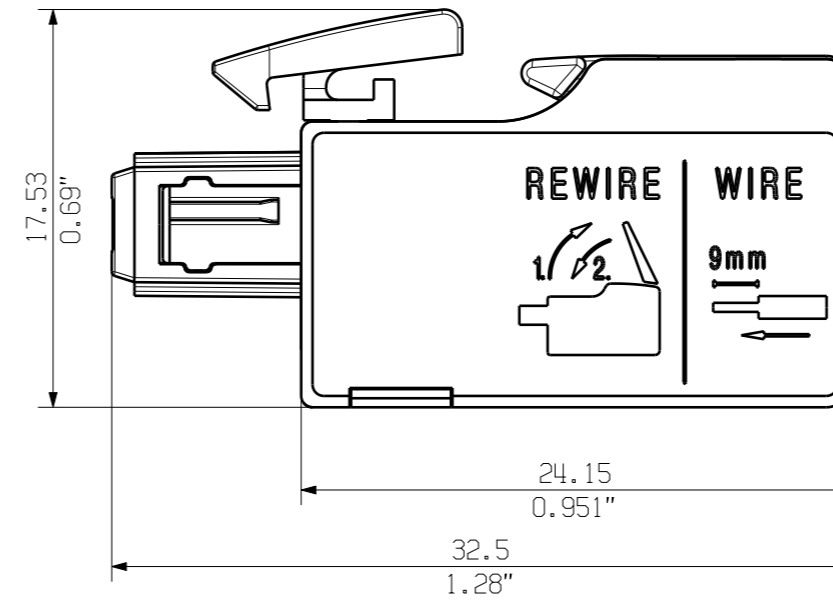
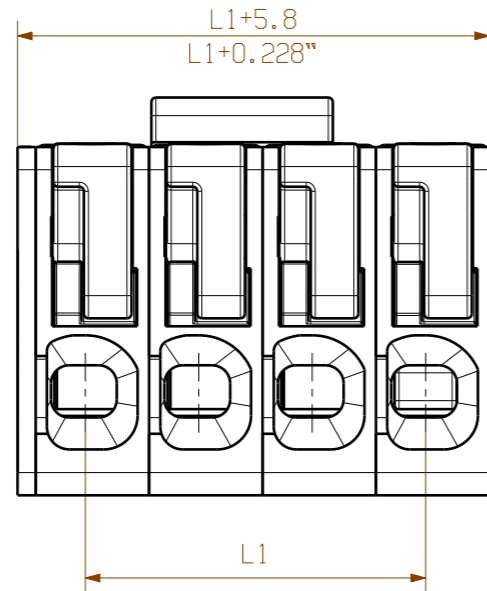

M 1/1

|         |         |           |
|---------|---------|-----------|
| 12      | 55.00   | 2.165     |
| 11      | 50.00   | 1.969     |
| 10      | 45.00   | 1.772     |
| 9       | 40.00   | 1.575     |
| 8       | 35.00   | 1.378     |
| 7       | 30.00   | 1.181     |
| 6       | 25.00   | 0.984     |
| 5       | 20.00   | 0.787     |
| 4       | 15.00   | 0.591     |
| 3       | 10.00   | 0.394     |
| 2       | 5.00    | 0.197     |
| n Poles | L1 [mm] | L1 [inch] |

Further dim. & info. see data sheet

General tolerance:  
 DIN ISO 2768-mK

For the mounting of PCBs, it should be noted that the rated data given in the catalogue relates only to the connection elements. The necessary creepage and clearance paths must be observed in connection with the respective applicant in accordance with VDE 0110. The current-carrying capacity and pitch tolerance is to be determined according to DIN IEC 326 part 3 very fine.

Weidmueller connectors are tested to the DIN VDE 0627 standard, and are valid for its field of application. Provided that the connectors are used to the intended purpose, all requirements with respect to the occurring of electrical, mechanical, thermic and corrosive stress will be satisfied.

|                   |                                |                              |  |
|-------------------|--------------------------------|------------------------------|--|
|                   | EC00003734<br>P028441          | Prim PLM Part No.: .         | Prim ERP Part No.: .   |
|                   | First Issue Date<br>07.05.2020 | Max. nos.<br>Modification    |  |
|                   | Date<br>23.06.2020             | Name<br>Tauber-Reglin,       | <b>72561</b><br>Drawing no. Issue no.<br>Sheet 6 of 8 sheets |
| Scale: ./.        | Size: A3                       | Responsible<br>Schmitz, Till |  |
| Drawings Assembly | Approved<br>16.07.2020         | Name<br>Sapina, Svetos       | <b>MPS 5/... TN B B</b><br>STIFTLAISTE<br>MALE PLUG          |
| Product file:     |                                |                              |  |