

13	12	11
PART NO.	ENG. NO.	FORM
02-09-1615	42477-0005	CHAIN

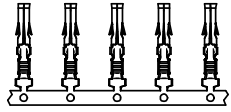

CHAIN FORM SHOWN
FULL SCALE

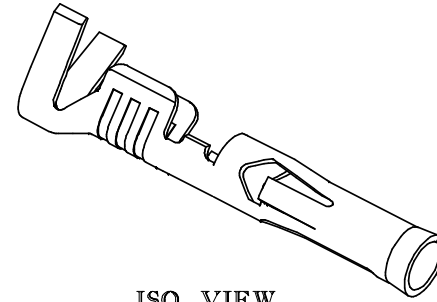
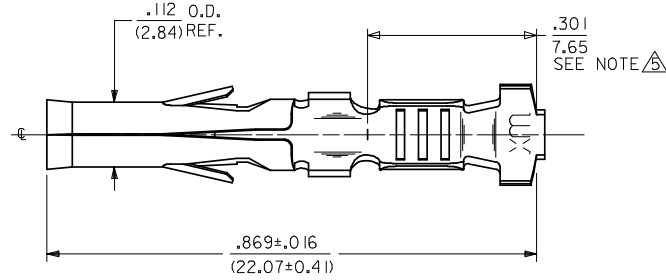

ISO VIEW

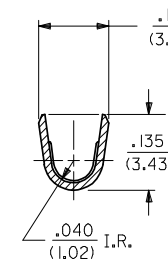
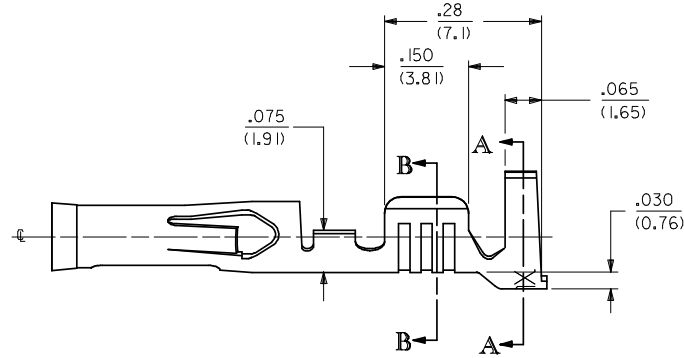
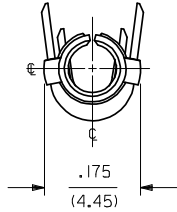

SECT. B-B

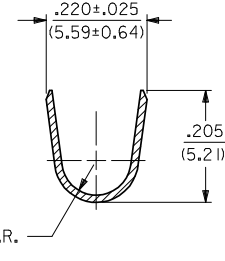

SECT. A-A

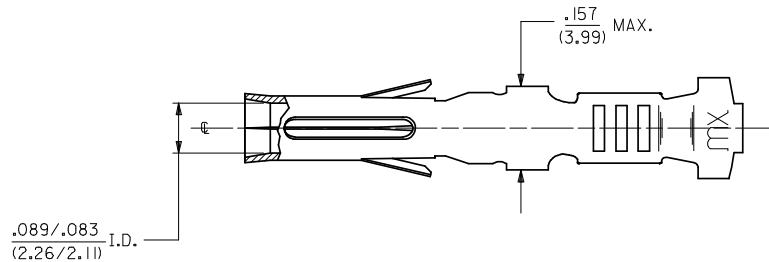

NOTES:

1. MATERIAL: 70/30 CARTRIDGE BRASS PER ES-124-D209.
2. FINISH: HOT TIN DIP, .000080/(0.00203) TO .000020/(0.00051) THICK.
3. PRODUCT SPECIFICATION PSX-42477 APPLIES.
4. THESE TERMINALS ARE FOR USE WITH .093/(2.36) SERIES HOUSINGS AND ACCEPT #14 THRU #18 AWG WIRE WITH A MAXIMUM INSULATION DIAMETER OF .140/(3.56).

DIMENSION FROM THE END OF TERMINAL TO THE END OF THE BRUSH ON THE WIRE CRIMPED INTO THE TERMINAL.

REVISE NOTE 2 EC NO: UCP2009-0059 DRAWN: GAVERILL 2008/07/08 CHKD: JBELL 2008/07/10 APPR: FSM/TH 2008/07/10	DESCRIPTION	QUALITY SYMBOLS	GENERAL TOLERANCES (UNLESS SPECIFIED)	DIMENSION STYLE	SCALE	DESIGN UNITS	THIRD ANGLE PROJECTION													
		 	<table border="1"> <tr> <th></th> <th>mm</th> <th>INCH</th> </tr> <tr> <td>4 PLACES</td> <td>± .005</td> <td>± .0005</td> </tr> <tr> <td>3 PLACES</td> <td>± .005</td> <td>± .010</td> </tr> <tr> <td>2 PLACES</td> <td>± 0.25</td> <td>± .014</td> </tr> <tr> <td>1 PLACE</td> <td>± 0.35</td> <td>± .014</td> </tr> </table>		mm	INCH	4 PLACES	± .005	± .0005	3 PLACES	± .005	± .010	2 PLACES	± 0.25	± .014	1 PLACE	± 0.35	± .014	IN/MM	6:1
	mm	INCH																		
4 PLACES	± .005	± .0005																		
3 PLACES	± .005	± .010																		
2 PLACES	± 0.25	± .014																		
1 PLACE	± 0.35	± .014																		
G1	REV		DRAFT WHERE APPLICABLE MUST REMAIN WITHIN DIMENSIONS	MATERIAL NO.	APPROVED BY	DATE	TITLE													
				02-09-1615	GMC	1989/06/21	TERMINAL, SOCKET .093/(2.36) DIA., CRIMP FOR 14-18 AWG													
					RHR	1989/06/21														
					APPROVED BY	DATE														
					GW	1989/06/21														
					MATERIAL NO. 02-09-1615		DOCUMENT NO. SD-42477-****													
					SIZE C THIS DRAWING CONTAINS INFORMATION THAT IS PROPRIETARY TO MOLEX INCORPORATED AND SHOULD NOT BE USED WITHOUT WRITTEN PERMISSION		SHEET NO. 1 OF 1													