

TL3300 SERIES TACT SWITCH

ANTI-VANDAL SWITCHES
 DETECTOR SWITCHES
 DIP SWITCHES
 KEYLOCK SWITCHES
 NAVIGATION SWITCHES
 PUSHBUTTON SWITCHES
 ROCKER SWITCHES
 ROTARY SWITCHES
 SLIDE SWITCHES
 SNAP ACTION SWITCHES
TACTILE SWITCHES
 TOGGLE SWITCHES
 CAP OPTIONS

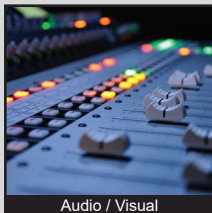

APPLICATIONS / MARKETS



Audio / Visual



Computer Peripherals

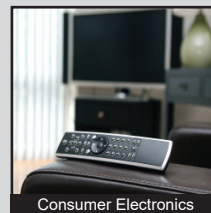

Consumer Electronics



Instrumentation



Medical Equipment



Telecommunication

RoHS

SPECIFICATIONS

Electrical Rating: 50mA, 12VDC
Life Expectancy: up to 200,000 Cycles
Contact Resistance: 100mΩ Max.
Insulation Resistance: 100MΩ Min. at 500VDC
Dielectric Strength: 250VAC for 1 Minute
Operating Temperature: -25°C to 70°C
Operating Force: 160gf (200,000 cycles)
 260gf (100,000 cycles)
 320gf, 520gf (50,000 cycles)
Travel: 0.35mm
Function: SPST, Off-(On), Momentary

FEATURES & BENEFITS

- Up to 200,000 cycle life expectancy
- Multiple actuator options
- Multiple force options

PART NUMBER CONFIGURATOR

Series	Circuit	Actuator "L"	Operating Force	Plating
TL	3300 - Off-(On)	A - 7.3mm (Knob: 3.8mm Sq.) C - 8.5mm D - 4.3mm	F160 - 160 gf F260 - 260 gf F320 - 320 gf F520 - 520 gf	Q - Silver

Specifications subject to change without notice 2.19.2019



E-SWITCH®

www.e-switch.com

800.867.2717

1

TL3300 SERIES TACT SWITCH

BODY DIMENSIONS ACTUATOR OPTION A

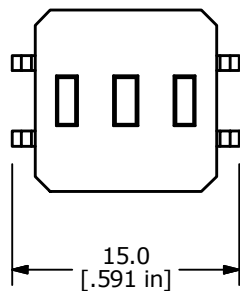
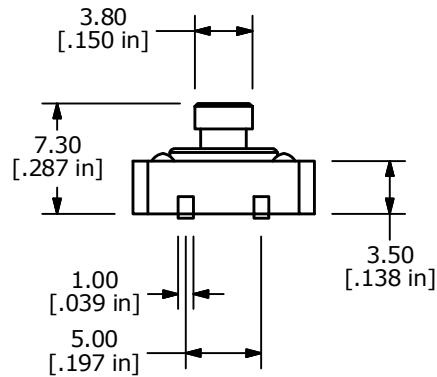
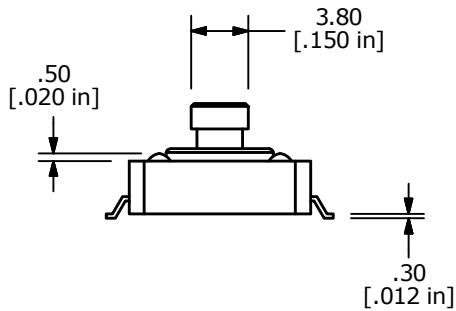
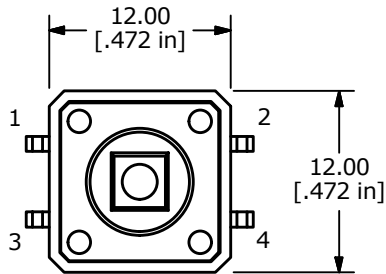
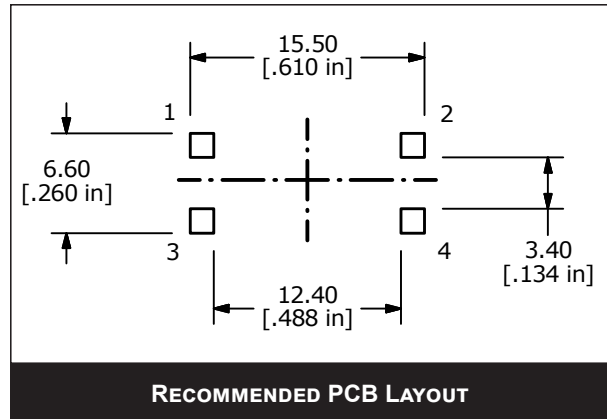
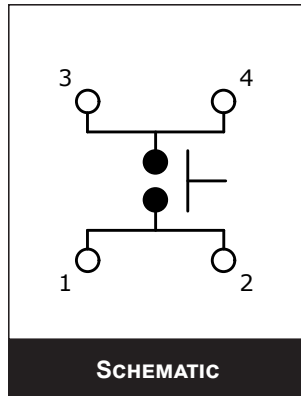

- ANTI-VANDAL SWITCHES
- DETECTOR SWITCHES
- DIP SWITCHES
- KEYLOCK SWITCHES
- NAVIGATION SWITCHES
- PUSHBUTTON SWITCHES
- ROCKER SWITCHES
- ROTARY SWITCHES
- SLIDE SWITCHES
- SNAP ACTION SWITCHES
- TACTILE SWITCHES**
- TOGGLE SWITCHES
- CAP OPTIONS

TL3300 SERIES TACT SWITCH

BODY DIMENSIONS ACTUATOR OPTION C

- ANTI-VANDAL SWITCHES
- DETECTOR SWITCHES
- DIP SWITCHES
- KEYLOCK SWITCHES
- NAVIGATION SWITCHES
- PUSHBUTTON SWITCHES
- ROCKER SWITCHES
- ROTARY SWITCHES
- SLIDE SWITCHES
- SNAP ACTION SWITCHES
- TACTILE SWITCHES**
- TOGGLE SWITCHES
- CAP OPTIONS

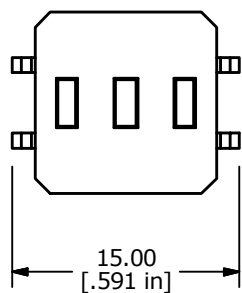
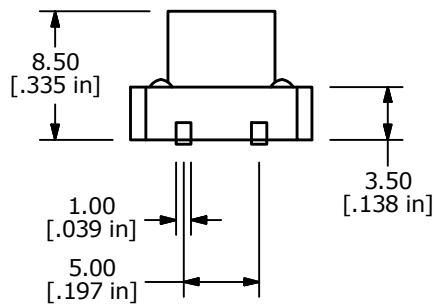
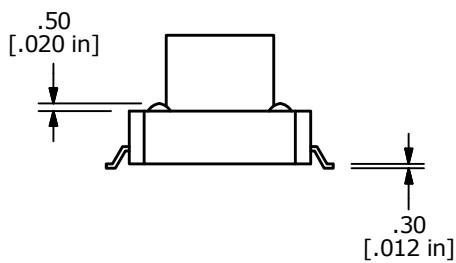
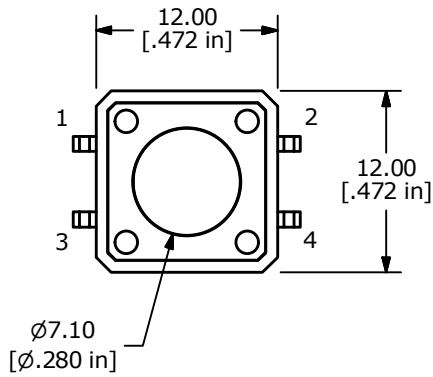
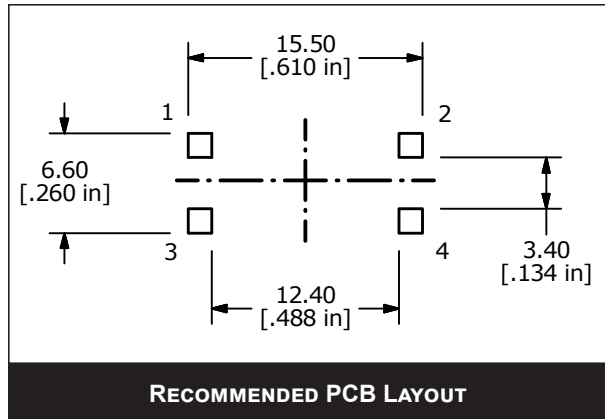
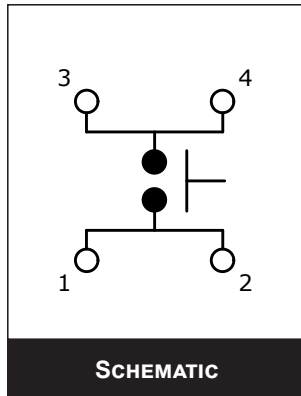

TL3300 SERIES TACT SWITCH

BODY DIMENSIONS ACTUATOR OPTION D

