



UM30-215111

UM30

ULTRASONIC SENSORS

**SICK**  
Sensor Intelligence.



### Ordering information

Type	Part no.
UM30-215111	6037663

Other models and accessories → [www.sick.com/UM30](http://www.sick.com/UM30)



### Detailed technical data

#### Mechanics/electronics

<b>Supply voltage <math>V_s</math></b>	DC 9 V ... 30 V <sup>1)</sup>
<b>Power consumption</b>	≤ 2.4 W <sup>2)</sup>
<b>Initialization time</b>	< 300 ms
<b>Design</b>	Cylindrical
<b>Housing material</b>	Metal (nickel-plated brass, PBT) Ultrasonic transducer: polyurethane foam, glass epoxy resin
<b>Thread size</b>	M30 x 1.5
<b>Connection type</b>	Male connector, M12, 5-pin
<b>Indication</b>	LED display, 2 x LED
<b>Weight</b>	270 g
<b>Sending axis</b>	Straight
<b>Dimensions (W x H x D)</b>	65 mm x 65 mm x 105 mm
<b>Enclosure rating</b>	IP65 / IP67
<b>Protection class</b>	III

<sup>1)</sup> Limit values, reverse-polarity protected Operation in short-circuit protected network: max. 8 A, class 2.

<sup>2)</sup> Without load.

#### Safety-related parameters

<b>MTTF<sub>D</sub></b>	101 years
<b>DC<sub>avg</sub></b>	0%

#### Performance

<b>Operating range, limiting range</b>	600 mm ... 6,000 mm, 8,000 mm
<b>Target</b>	Natural objects
<b>Resolution</b>	≥ 0.18 mm

<sup>1)</sup> In relation to the current measured value, minimum value ≥ resolution.

<sup>2)</sup> Referring to current measurement value.

<sup>3)</sup> Temperature compensation can be switched off, without temperature compensation: 0.17 % / K.

<b>Repeatability</b>	± 0.15 % <sup>1)</sup>
<b>Accuracy</b>	± 1 % <sup>2) 3)</sup>
<b>Temperature compensation</b>	✓
<b>Response time</b>	240 ms
<b>Switching frequency</b>	3 Hz
<b>Output time</b>	60 ms
<b>Ultrasonic frequency (typical)</b>	80 kHz
<b>Detection area (typical)</b>	See diagrams
<b>Additional function</b>	Adjustable operating modes: Switching point (Dt0) / Switching window/Background (ObSB), teach-in of digital output, set levels of digital outputs, invertable digital output, set on delay digital output, synchronization of up to 50 sensors, multiplexing: no cross talk of up to 50 sensors, adjustable measurement filters: Measured value filters/Filter strength/Foreground suppression/Detection area/Sensitivity and sound beam, Display (can be deactivated), reset to factory default

<sup>1)</sup> In relation to the current measured value, minimum value ≥ resolution.

<sup>2)</sup> Referring to current measurement value.

<sup>3)</sup> Temperature compensation can be switched off, without temperature compensation: 0.17 % / K.

## Interfaces

<b>Digital output</b>	Number	1 <sup>1)</sup>
	Type	PNP
	Maximum output current $I_A$	≤ 200 mA
<b>Multifunctional input (MF)</b>		1 x MF
<b>Hysteresis</b>		100 mm

<sup>1)</sup> PNP: HIGH =  $V_S - (< 2 V)$  / LOW = 0 V.

## Ambient data

<b>Ambient temperature, operation</b>	-25 °C ... +70 °C
<b>Ambient temperature, storage</b>	-40 °C ... +85 °C

## Classifications

<b>eCl@ss 5.0</b>	27270804
<b>eCl@ss 5.1.4</b>	27270804
<b>eCl@ss 6.0</b>	27270804
<b>eCl@ss 6.2</b>	27270804
<b>eCl@ss 7.0</b>	27270804
<b>eCl@ss 8.0</b>	27270804
<b>eCl@ss 8.1</b>	27270804
<b>eCl@ss 9.0</b>	27270804
<b>eCl@ss 10.0</b>	27270804
<b>eCl@ss 11.0</b>	27270804
<b>eCl@ss 12.0</b>	27272806
<b>ETIM 5.0</b>	EC001846
<b>ETIM 6.0</b>	EC001846

<b>ETIM 7.0</b>	EC001846
<b>ETIM 8.0</b>	EC001846
<b>UNSPSC 16.0901</b>	411111960

### Dimensional drawing (Dimensions in mm (inch))

UM30-215

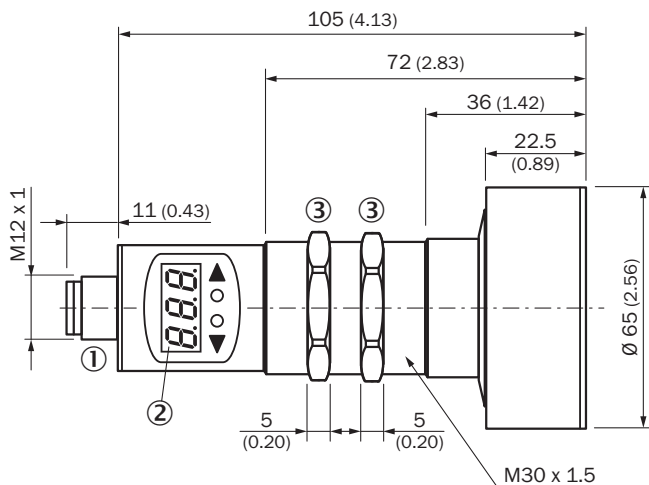

- ① Connection
- ② Display
- ③ Mounting nuts, SW 36 mm

### Connection type

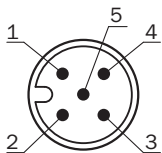

### Connection diagram

UM30-21x111 UM30-21x114 Connector M12, 5-pin

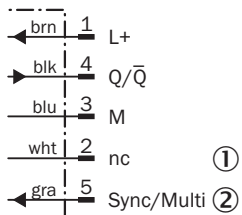

- ① Not assigned
- ② Synchronization and multiplex operation/communication Connect+

Adjustment possible

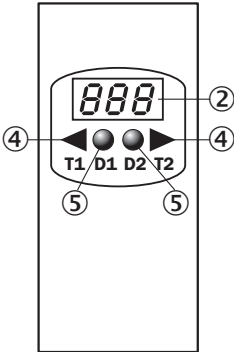

- ② Display
- ④ Control elements
- ⑤ Status indicators

Detection area

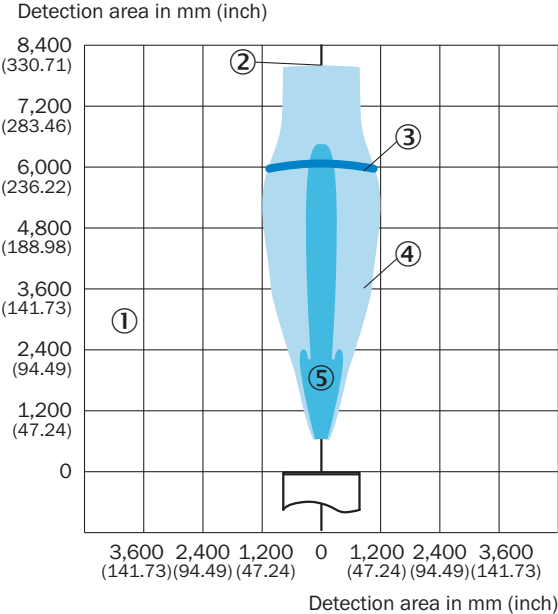

UM30-215, UC30-215



- ① Detection range dependent on reflection properties, size, and alignment of the object
- ② Limiting range
- ③ Operating range
- ④ Example object: aligned plate 500 mm x 500 mm
- ⑤ Example object: pipe with 27 mm diameter

### Recommended accessories

Other models and accessories → [www.sick.com/UM30](http://www.sick.com/UM30)

	Brief description	Type	Part no.
<b>Cloning module</b>			
	Tool for visualization, configuration and cloning, 3-digit LED display, supply voltage: DV 9 V ... 30 V	Connect+ adapter (CPA)	6037782
<b>Mounting brackets and plates</b>			
	Mounting bracket for M30 sensors, steel, zinc coated, without mounting hardware	BEF-WN-M30	5308445
<b>Plug connectors and cables</b>			
	Head A: female connector, M12, 5-pin, straight, A-coded Head B: Flying leads Cable: Sensor/actuator cable, PVC, unshielded, 2 m	YF2A15-020VB5XLEAX	2096239

### Recommended services

Additional services → [www.sick.com/UM30](http://www.sick.com/UM30)

	Type	Part no.
<b>Extended warranty</b>		
<ul style="list-style-type: none"> <li>• <b>Product area:</b> Identification solutions, machine vision, Distance sensors, Detection and ranging solutions</li> <li>• <b>Range of services:</b> The services correspond to the scope of the statutory manufacturer warranty (SICK general terms of delivery).</li> <li>• <b>Duration:</b> Five-year warranty from delivery date.</li> </ul>	Extended warranty for a total of five years from delivery date	1680671

## SICK AT A GLANCE

SICK is one of the leading manufacturers of intelligent sensors and sensor solutions for industrial applications. A unique range of products and services creates the perfect basis for controlling processes securely and efficiently, protecting individuals from accidents and preventing damage to the environment.

We have extensive experience in a wide range of industries and understand their processes and requirements. With intelligent sensors, we can deliver exactly what our customers need. In application centers in Europe, Asia and North America, system solutions are tested and optimized in accordance with customer specifications. All this makes us a reliable supplier and development partner.

Comprehensive services complete our offering: SICK LifeTime Services provide support throughout the machine life cycle and ensure safety and productivity.

For us, that is “Sensor Intelligence.”

## WORLDWIDE PRESENCE:

Contacts and other locations –[www.sick.com](http://www.sick.com)