

T322 & T323 MIL-PRF-49137/1 and /5 (CX01 & CX05 Style)

Overview

The T322 and T323 (CX01 and CX05) capacitors are a complete line of extended range molded solid tantalum capacitors designed specifically for high-speed automatic insertion applications. These capacitors offer an extremely high capacitance-to-volume ratio while still maintaining excellent performance characteristics. Supplied in six axial lead tubular case sizes, these capacitors are ideally suited for use in printed wiring boards and all applications requiring a high degree of packaging density.

These capacitors can be supplied in bulk packaging or lead-taped on reels. The T322/T323 capacitor dimensions and tight lead wire-to-body concentricity permit installation by the same automatic insertion equipment used for diodes and resistors. The gold-colored epoxy permits laser marking with outstanding permanency and legibility. T323 capacitors are qualified under MIL-PRF-49137/1 and 5 as Military Style CX01 and CX05.

Benefits

- Taped and reeled per EIA Specification RS-296
- Laser-marked case
- Qualified to MIL-PRF-49137/1 and 5 (CX01 and CX05 Style)
- Capacitance values of 0.1 to 330 μ F
- Tolerances of $\pm 5\%$, $\pm 10\%$ and $\pm 20\%$ (M and K only tolerances available for T323 Series)
- Voltage rating of 2 – 50 VDC
- Operating temperature range of -55°C to $+85^{\circ}\text{C}$
- Case sizes: A, B, C, D, E, F

Applications

Typical applications include decoupling, blocking, bypassing and filtering in commercial computers, data processing, communications, and other electronic equipment. This product is well-suited for decoupling required by high speed computers due to its low ESR/impedance at high frequencies.



Ordering Information

| T | 32X | A | 105 | M | 035 | A | T | |
|-----------------|--|----------------------------|--|----------------------------------|---|-------------------------------|--|-----------------------------|
| Capacitor Class | Series | Case Size | Capacitance Code (pF) | Capacitance Tolerance | Rated Voltage (VDC) | Failure Rate/Military Product | Termination Finish | Packaging |
| T = Tantalum | Axial Molded Polar Solid Tantalum. Insert appropriate number to replace letter "X" 322 = Commercial Grade Series 323 = Qualified under MIL-PRF-49137/1 and 5 (CX01/CX05 Style) | A B C D E F | First two digits represent significant figures. Third digit specifies number of zeros to follow. | J = ±5%* K = ±10% M = ±20% | 002 = 2 004 = 4 006 = 6 010 = 10 015 = 15 020 = 20 025 = 25 035 = 35 050 = 50 | Not Applicable | S = Standard (solder-coated nickel) T = 100% tin (Sn)- plated | Blank = Bulk 7200 = Reel |

* J Tolerance available in T322 series only

MIL-PRF-49137/1/5 (CX01 and CX05 Style)

| CX01 | D | 475 | K |
|---|---|--|-----------------------|
| Style | Rated Voltage (VDC) | Capacitance Code (pF) | Capacitance Tolerance |
| CX = Capacitors, Solid Electrolyte, Tantalum, Polar, Molded, Nonhermetically Sealed. 01 / 05 = Style | D = 6 F = 10 H = 15 J = 20 K = 25 M = 35 N = 50 | First two digits represent significant figures. Third digit specifies number of zeros to follow. | K = ±10% M = ±20% |

Performance Characteristics

| Item | Performance Characteristics |
|-------------------------------------|--|
| Operating Temperature | -55°C to 125°C |
| Rated Capacitance Range | 0.1 – 330 µF at 120 Hz/25°C |
| Capacitance Tolerance | J Tolerance (5%), K Tolerance (10%), M Tolerance (20%) |
| Rated Voltage Range | 2 – 50 V |
| DF (120 Hz at 25°C) | Refer to Part Number Electrical Specification Table |
| ESR and Impedance (100 kHz at 25°C) | Refer to Part Number Electrical Specification Table (for reference only) |
| Leakage Current | Refer to Part Number Electrical Specification Table (rated voltage up to +85°C and 2/3 of rated voltage applied at 125°C) |

Dimensions – Inches (Millimeters)

Metric will govern

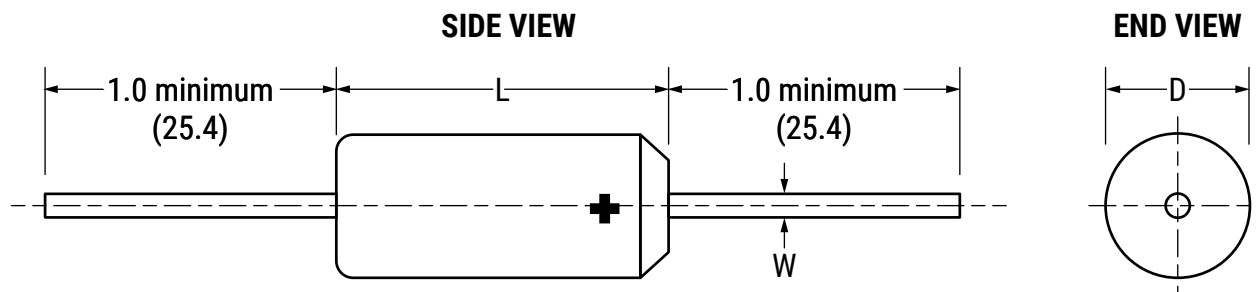

| Case Size | D Maximum | L Maximum | W |
|-----------|--------------|---------------|--------------|
| A | 0.095 (2.41) | 0.260 (6.60) | 0.020 (0.51) |
| B | 0.110 (2.79) | 0.290 (7.37) | 0.020 (0.51) |
| C | 0.180 (4.57) | 0.345 (8.76) | 0.020 (0.51) |
| D | 0.180 (4.57) | 0.420 (10.67) | 0.020 (0.51) |
| E | 0.280 (7.11) | 0.530 (13.46) | 0.025 (0.64) |
| F | 0.300 (7.62) | 0.710 (18.03) | 0.025 (0.64) |

CX Style

| KEMET Case Size | Style | MIL Case Size | Dimensions | | |
|-----------------|-------------|---------------|-----------------------------|------------------------------|------------------------------|
| | | | D | L | W |
| A | CX01 / CX05 | A | 0.085 ±0.015 (2.16±0.38) | 0.250 ±0.020 (6.35±0.51) | 0.020 ±0.002 (0.51 ±.050) |
| B | | A*/B | 0.100 ±0.015 (2.54±0.38) | 0.280 ±0.020 (7.11±0.51) | 0.020 ±0.002 (0.51 ±.050) |
| C | | C | 0.170 ±0.015 (4.32±0.38) | 0.335 ±0.020 (8.51±0.51) | 0.020 ±0.002 (0.51 ±.050) |
| D | | D | 0.170 ±0.015 (4.32±0.38) | 0.410 ±0.020 (10.41±0.51) | 0.020 ±0.002 (0.51 ±.050) |

*1 There may be a disconnect between the Case Size Designator in MIL-PRF-49137/1 for the CX01 Style but dimensionally, the KEMET Case Size meets the dimensional requirements of the MIL-PRF.

Table 1 – Ratings & Part Number Reference

| Rated Voltage | Rated Cap | Case Code/ Case Size | KEMET Part Number | DC Leakage | DF | CX01 & CX05 Capacitors per MIL-PRF-49137/1 & 5 | |
|---------------|-----------|-------------------------|------------------------------|--------------------------|--------------------------|--|-------------------|
| (V) 85°C | µF | | (See below for part options) | µA at 25°C Max/5 Minimum | % at 25°C 120 Hz Maximum | Military Part Number | KEMET Part Number |
| Rated Voltage | Rated Cap | Case Code/ Case Size | KEMET Part Number | DC Leakage | DF | CX01 & CX05 Capacitors per MIL-PRF-49137/1 & 5 | |
| 2 | 6.8 | A | T322A685(1)002A(2) | 0.5 | 10 | | |
| 2 | 8.2 | A | T322A825(1)002A(2) | 0.5 | 10 | | |
| 2 | 10.0 | A | T322A106(1)002A(2) | 0.5 | 10 | | |
| 2 | 12.0 | B | T322B126(1)002A(2) | 0.5 | 10 | | |
| 2 | 15.0 | B | T322B156(1)002A(2) | 0.5 | 10 | | |
| 2 | 18.0 | B | T322B186(1)002A(2) | 0.5 | 10 | | |
| 2 | 22.0 | B | T322B226(1)002A(2) | 0.5 | 10 | | |
| 2 | 27.0 | B | T322B276(1)002A(2) | 0.5 | 10 | | |
| 2 | 33.0 | B | T322B336(1)002A(2) | 0.5 | 10 | | |
| 2 | 39.0 | C | T322C396(1)002A(2) | 0.6 | 10 | | |
| 2 | 47.0 | C | T322C476(1)002A(2) | 0.8 | 10 | | |
| 2 | 56.0 | C | T322C566(1)002A(2) | 0.9 | 10 | | |
| 2 | 68.0 | C | T322C686(1)002A(2) | 1.1 | 10 | | |
| 4 | 4.7 | A | T322A475(1)004A(2) | 0.5 | 8 | | |
| 4 | 5.6 | A | T322A565(1)004A(2) | 0.5 | 8 | | |
| 4 | 6.8 | A | T322A685(1)002A(2) | 0.5 | 8 | | |
| 4 | 8.2 | B | T322B825(1)004A(2) | 0.5 | 8 | | |
| 4 | 10.0 | B | T322B106(1)004A(2) | 0.5 | 8 | | |
| 4 | 12.0 | B | T322B126(1)004A(2) | 0.5 | 8 | | |
| 4 | 15.0 | B | T322B156(1)004A(2) | 0.5 | 8 | | |
| 4 | 18.0 | B | T322B186(1)004A(2) | 0.6 | 8 | | |
| 4 | 22.0 | B | T322B226(1)004A(2) | 0.7 | 8 | | |
| 4 | 27.0 | C | T322C276(1)004A(2) | 0.9 | 8 | | |
| 4 | 33.0 | C | T322C336(1)004A(2) | 1.1 | 8 | | |
| 4 | 39.0 | C | T322C396(1)004A(2) | 1.2 | 8 | | |
| 4 | 47.0 | C | T322C476(1)004A(2) | 1.5 | 8 | | |
| 4 | 56.0 | D | T322D566(1)004A(2) | 1.8 | 8 | | |
| 4 | 68.0 | D | T322D686(1)004A(2) | 2.2 | 8 | | |
| 6 | 3.3 | A | T322A335(1)006A(2) | 0.5 | 4 | | |
| 6 | 3.9 | A | T322A395(1)006A(2) | 0.5 | 4 | | |
| 6 | 3.9 | B | T322B395(1)006A(2) | 1.0 | 6 | CX01D395(3) | T323B395(3)006AS |
| 6 | 4.7 | A | T322A475(1)006A(2) | 0.5 | 4 | CX05D475(3) | T323A475(3)006AS |
| 6 | 4.7 | B | T322B475(1)006A(2) | 1.0 | 6 | CX01D475(3) | T323B475(3)006AS |
| 6 | 5.6 | B | T322B565(1)006A(2) | 1 | 6 | CX01D565(3) | T323B565(3)006AS |
| 6 | 6.8 | B | T322B685(1)006A(2) | 1 | 6 | CX01D685(3) | T323B685(3)006AS |
| 6 | 8.2 | B | T322B825(1)006A(2) | 1 | 8 | CX01D825(3) | T323B825(3)006AS |
| 6 | 10.0 | B | T322B106(1)006A(2) | 1 | 8 | CX01D106(3) | T323B106(3)006AS |
| 6 | 12.0 | B | T322B126(1)006A(2) | 1 | 8 | CX01D126(3) | T323B126(3)006AS |
| 6 | 15.0 | B | T322B156(1)006A(2) | 1 | 8 | CX05D156(3) | T323B156(3)006AS |
| 6 | 18.0 | C | T322C186(1)006A(2) | 0.9 | 6 | | |
| 6 | 22.0 | C | T322C226(1)006A(2) | 1.1 | 6 | | |
| 6 | 27.0 | C | T322C276(1)006A(2) | 1.3 | 6 | | |
| 6 | 33.0 | C | T322C336(1)006A(2) | 1.5 | 8 | CX05D336(3) | T323C336(3)006AS |
| 6 | 39.0 | D | T322D396(1)006A(2) | 1.9 | 6 | | |
| 6 | 47.0 | D | T322D476(1)006A(2) | 3 | 8 | CX05D476(3) | T323D476(3)006AS |
| 6 | 56.0 | D | T322D566(1)006A(2) | 2.7 | 6 | | |
| 6 | 68.0 | D | T322D686(1)006A(2) | 3.3 | 6 | | |
| 6 | 82.0 | E | T322E826(1)006A(2) | 3.9 | 8 | | |
| 6 | 100.0 | E | T322E107(1)006A(2) | 4.8 | 8 | | |
| 6 | 120.0 | E | T322E127(1)006A(2) | 5.0 | 8 | | |
| (V) 85°C | µF | | (see below for part options) | µA at 25°C Max/5 Minimum | % at 25°C 120 Hz Maximum | Military Part Number | KEMET Part Number |
| Rated Voltage | Rated Cap | Case Code/ Case Size | KEMET Part Number | DC Leakage | DF | CX01 & CX05 Capacitors per MIL-PRF-49137/1 & 5 | |

(1) To complete KEMET part number, insert M for ±20%, K for ±10% or J for 5%. Designates capacitance tolerance.

(2) To complete KEMET part number, insert T = 100% Matte Tin (Sn) Plated, S = Standard Solder coated (SnPb 5% Pb minimum). Designates termination finish.

(3) To complete MIL-PRF part number, insert M for ± 20%, K for ± 10%. Designates Capacitance tolerance.

(4) To complete MIL-PRF part number, insert 01 for specification sheet /1 or 05 for specification sheet /5.

Table 1 – Ratings & Part Number Reference cont.

| Rated Voltage | Rated Cap | Case Code/ Case Size | KEMET Part Number | DC Leakage | DF | CX01 & CX05 Capacitors per MIL-PRF-49137/1 & 5 | |
|---------------|-----------|-------------------------|------------------------------|--------------------------|--------------------------|--|-------------------|
| (V) 85°C | µF | | (See below for part options) | µA at 25°C Max/5 Minimum | % at 25°C 120 Hz Maximum | Military Part Number | KEMET Part Number |
| Rated Voltage | Rated Cap | Case Code/ Case Size | KEMET Part Number | DC Leakage | DF | CX01 & CX05 Capacitors per MIL-PRF-49137/1 & 5 | |
| 6 | 150.0 | E | T322E157(1)006A(2) | 5.0 | 8 | | |
| 6 | 180.0 | E | T322E187(1)006A(2) | 8.6 | 8 | | |
| 6 | 220.0 | E | T322E227(1)006A(2) | 10.0 | 8 | | |
| 6 | 270.0 | F | T322F277(1)006A(2) | 10.0 | 8 | | |
| 6 | 330.0 | F | T322F337(1)006A(2) | 10.0 | 8 | | |
| 10 | 2.2 | A | T322A225(1)010A(2) | 0.5 | 4 | | |
| 10 | 2.7 | A | T322A275(1)010A(2) | 0.5 | 4 | | |
| 10 | 2.7 | B | T322B275(1)010A(2) | 1.0 | 6 | CX01F275(3) | T323B275(3)010AS |
| 10 | 3.3 | A | T322A335(1)010A(2) | 1.0 | 6 | CX05F335(3) | T323A335(3)010AS |
| 10 | 3.3 | B | T322B335(1)010A(2) | 1.0 | 6 | CX01F335(3) | T323B335(3)010AS |
| 10 | 3.9 | B | T322B395(1)010A(2) | 0.5 | 4 | | |
| 10 | 4.7 | B | T322B475(1)010A(2) | 0.5 | 4 | | |
| 10 | 5.6 | B | T322B565(1)010A(2) | 0.5 | 4 | | |
| 10 | 6.8 | B | T322B685(1)010A(2) | 0.5 | 6 | | |
| 10 | 8.2 | B | T322B825(1)010A(2) | 0.7 | 6 | | |
| 10 | 10.0 | B | T322B106(1)010A(2) | 1.0 | 8 | CX05F106(3) | T323B106(3)010AS |
| 10 | 12.0 | C | T322C126(1)010A(2) | 1.0 | 6 | | |
| 10 | 15.0 | C | T322C156(1)010A(2) | 1.2 | 6 | | |
| 10 | 18.0 | C | T322C186(1)010A(2) | 1.4 | 6 | | |
| 10 | 22.0 | C | T322C226(1)010A(2) | 1.5 | 8 | CX05F226(3) | T323C226(3)010AS |
| 10 | 27.0 | D | T322D276(1)010A(2) | 2.0 | 8 | CX05F276(3) | T323D276(3)010AS |
| 10 | 33.0 | D | T322D336(1)010A(2) | 3 | 8 | CX05F336(3) | T323D336(3)010AS |
| 10 | 39.0 | D | T322D396(1)010A(2) | 5 | 8 | CX05F396(3) | T323D396(3)010AS |
| 10 | 47.0 | D | T322D476(1)010A(2) | 5 | 8 | CX05F476(3) | T323D476(3)010AS |
| 10 | 56.0 | E | T322E566(1)010A(2) | 4.4 | 6 | | |
| 10 | 68.0 | E | T322E686(1)010A(2) | 5.0 | 6 | | |
| 10 | 82.0 | E | T322E826(1)010A(2) | 5.0 | 8 | | |
| 10 | 100.0 | E | T322E107(1)010A(2) | 8.0 | 8 | | |
| 10 | 120.0 | E | T322E127(1)010A(2) | 9.6 | 8 | | |
| 10 | 150.0 | E | T322E157(1)010A(2) | 10.0 | 8 | | |
| 10 | 180.0 | F | T322F187(1)010A(2) | 10.0 | 8 | | |
| 10 | 220.0 | F | T322F227(1)010A(2) | 10.0 | 8 | | |
| 15 | 1.5 | A | T322A155(1)015A(2) | 0.5 | 4 | | |
| 15 | 1.8 | A | T322A185(1)015A(2) | 0.5 | 4 | | |
| 15 | 2.2 | A | T322A225(1)015A(2) | 1.0 | 6 | CX05H225(3) | T323A225(3)015AS |
| 15 | 2.7 | B | T322B275(1)015A(2) | 0.5 | 4 | | |
| 15 | 3.3 | B | T322B335(1)015A(2) | 0.5 | 4 | | |
| 15 | 3.9 | B | T322B395(1)015A(2) | 0.5 | 4 | | |
| 15 | 4.7 | B | T322B475(1)015A(2) | 0.6 | 4 | | |
| 15 | 5.6 | B | T322B565(1)015A(2) | 0.7 | 4 | | |
| 15 | 6.8 | B | T322B685(1)015A(2) | 1.0 | 6 | CX05H685(3) | T323B685(3)015AS |
| 15 | 8.2 | C | T322C825(1)015A(2) | 1.0 | 6 | | |
| 15 | 10.0 | C | T322C106(1)015A(2) | 1.2 | 6 | | |
| 15 | 12.0 | C | T322C126(1)015A(2) | 1.4 | 6 | | |
| 15 | 15.0 | C | T322C156(1)015A(2) | 1.5 | 8 | CX05H156(3) | T323C156(3)015AS |
| 15 | 18.0 | D | T322D186(1)015A(2) | 2.2 | 6 | | |
| 15 | 22.0 | D | T322D226(1)015A(2) | 3.0 | 8 | CX05H226(3) | T323D226(3)015AS |
| 15 | 27.0 | D | T322D276(1)015A(2) | 3.2 | 6 | | |
| 15 | 33.0 | D | T322D336(1)015A(2) | 5.0 | 8 | CX05H336(3) | T323D336(3)015AS |
| 15 | 39.0 | E | T322E396(1)015A(2) | 4.7 | 6 | | |
| (V) 85°C | µF | | (see below for part options) | µA at 25°C Max/5 Minimum | % at 25°C 120 Hz Maximum | Military Part Number | KEMET Part Number |
| Rated Voltage | Rated Cap | Case Code/ Case Size | KEMET Part Number | DC Leakage | DF | CX01 & CX05 Capacitors per MIL-PRF-49137/1 & 5 | |

(1) To complete KEMET part number, insert M for ±20%, K for ±10% or J for 5%. Designates capacitance tolerance.
(2) To complete KEMET part number, insert T = 100% Matte Tin (Sn) Plated, S = Standard Solder coated (SnPb 5% Pb minimum). Designates termination finish.
(3) To complete MIL-PRF part number, insert M for ± 20%, K for ± 10%. Designates Capacitance tolerance.
(4) To complete MIL-PRF part number, insert 01 for specification sheet /1 or 05 for specification sheet /5.

Table 1 – Ratings & Part Number Reference cont.

| Rated Voltage (V) 85°C | Rated Cap µF | Case Code/ Case Size | KEMET Part Number (See below for part options) | DC Leakage µA at 25°C Max/5 Minimum | DF % at 25°C 120 Hz Maximum | CX01 & CX05 Capacitors per MIL-PRF-49137/1 & 5 | |
|---------------------------|-----------------|-------------------------|---|---|-----------------------------------|--|-------------------|
| | | | | | | Military Part Number | KEMET Part Number |
| 15 | 47.0 | E | T322E476(1)015A(2) | 5.0 | 6 | | |
| 15 | 56.0 | E | T322E566(1)015A(2) | 6.7 | 6 | | |
| 15 | 68.0 | E | T322E686(1)015A(2) | 8.2 | 6 | | |
| 15 | 82.0 | E | T322E826(1)015A(2) | 9.8 | 8 | | |
| 15 | 100.0 | E | T322E107(1)015A(2) | 10.0 | 8 | | |
| 15 | 120.0 | F | T322F127(1)015A(2) | 10.0 | 8 | | |
| 15 | 150.0 | F | T322F157(1)015A(2) | 10.0 | 8 | | |
| 20 | 1.0 | A | T322A105(1)020A(2) | 0.5 | 4 | | |
| 20 | 1.2 | A | T322A125(1)020A(2) | 0.5 | 4 | | |
| 20 | 1.5 | A | T322A155(1)020A(2) | 1 | 6 | CX05J155(3) | T323A155(3)020AS |
| 20 | 1.8 | B | T322B185(1)020A(2) | 0.5 | 4 | | |
| 20 | 2.2 | B | T322B225(1)020A(2) | 0.5 | 4 | | |
| 20 | 2.7 | B | T322B275(1)020A(2) | 0.5 | 4 | | |
| 20 | 3.3 | B | T322B335(1)020A(2) | 0.5 | 4 | | |
| 20 | 3.9 | B | T322B395(1)020A(2) | 0.6 | 4 | | |
| 20 | 4.7 | B | T322B475(1)020A(2) | 1 | 6 | CX05J475(3) | T323B475(3)020AS |
| 20 | 5.6 | C | T322C565(1)020A(2) | 0.9 | 4 | | |
| 20 | 6.8 | C | T322C685(1)020A(2) | 1.1 | 6 | | |
| 20 | 8.2 | C | T322C825(1)020A(2) | 1.3 | 6 | | |
| 20 | 10.0 | C | T322C106(1)020A(2) | 1.6 | 6 | | |
| 20 | 12.0 | D | T322D126(1)020A(2) | 1 | 8 | CX05J126(3) | T323D126(3)020AS |
| 20 | 15.0 | D | T322D156(1)020A(2) | 3 | 8 | CX05J156(3) | T323D156(3)020AS |
| 20 | 18.0 | D | T322D186(1)020A(2) | 2.9 | 6 | | |
| 20 | 22.0 | D | T322D226(1)020A(2) | 3.5 | 6 | | |
| 20 | 27.0 | E | T322E276(1)020A(2) | 4.3 | 6 | | |
| 20 | 33.0 | E | T322E336(1)020A(2) | 5.0 | 6 | | |
| 20 | 39.0 | E | T322E396(1)020A(2) | 6.2 | 6 | | |
| 20 | 47.0 | E | T322E476(1)020A(2) | 7.5 | 6 | | |
| 20 | 56.0 | E | T322E566(1)020A(2) | 8.9 | 6 | | |
| 20 | 68.0 | E | T322E686(1)020A(2) | 10.0 | 6 | | |
| 20 | 82.0 | F | T322F826(1)020A(2) | 10.0 | 8 | | |
| 20 | 100.0 | F | T322F107(1)020A(2) | 10.0 | 8 | | |
| 20 | 120.0 | F | T322F127(1)020A(2) | 10.0 | 8 | | |
| 25 | 0.47 | A | T322A474(1)025A(2) | 0.5 | 3 | | |
| 25 | 0.56 | A | T322A564(1)025A(2) | 0.5 | 3 | | |
| 25 | 0.68 | A | T322A684(1)025A(2) | 0.5 | 3 | | |
| 25 | 0.82 | A | T322A824(1)025A(2) | 0.5 | 3 | | |
| 25 | 1.0 | A | T322A105(1)025A(2) | 1.0 | 4 | CX05K105(3) | T323A105(3)025AS |
| 25 | 1.2 | B | T322B125(1)025A(2) | 0.5 | 3 | | |
| 25 | 1.5 | B | T322B155(1)025A(2) | 1.0 | 6 | CX01K155(3) | T323B155(3)025AS |
| 25 | 1.8 | B | T322B185(1)025A(2) | 1.0 | 6 | CX01K185(3) | T323B185(3)025AS |
| 25 | 2.2 | B | T322B225(1)025A(2) | 1.0 | 6 | CX(4)K225(3) | T323B225(3)025AS |
| 25 | 2.7 | B | T322B275(1)025A(2) | 0.5 | 3 | | |
| 25 | 3.3 | B | T322B335(1)025A(2) | 1.0 | 6 | CX05K335(3) | T323B335(3)025AS |
| 25 | 3.9 | C | T322C395(1)025A(2) | 0.8 | 3 | | |
| 25 | 4.7 | C | T322C475(1)025A(2) | 0.9 | 4 | | |
| 25 | 5.6 | C | T322C565(1)025A(2) | 1.1 | 4 | | |
| 25 | 6.8 | C | T322C685(1)025A(2) | 1.5 | 6 | CX05K685(3) | T323C685(3)025AS |
| 25 | 8.2 | C | T322C825(1)025A(2) | 1.4 | 4 | | |
| 25 | 10.0 | C | T322C106(1)025A(2) | 1.5 | 8 | CX05K106(3) | T323C106(3)025AS |
| (V) 85°C | µF | Case Code/ Case Size | (see below for part options) | µA at 25°C Max/5 Minimum | % at 25°C 120 Hz Maximum | Military Part Number | KEMET Part Number |
| Rated Voltage | Rated Cap | | KEMET Part Number | DC Leakage | DF | CX01 & CX05 Capacitors per MIL-PRF-49137/1 & 5 | |

(1) To complete KEMET part number, insert M for ±20%, K for ±10% or J for 5%. Designates capacitance tolerance.

(2) To complete KEMET part number, insert T = 100% Matte Tin (Sn) Plated, S = Standard Solder coated (SnPb 5% Pb minimum). Designates termination finish.

(3) To complete MIL-PRF part number, insert M for ± 20%, K for ± 10%. Designates Capacitance tolerance.

(4) To complete MIL-PRF part number, insert 01 for specification sheet /1 or 05 for specification sheet /5.

Table 1 – Ratings & Part Number Reference cont.

| Rated Voltage | Rated Cap | Case Code/ Case Size | KEMET Part Number | DC Leakage | DF | CX01 & CX05 Capacitors per MIL-PRF-49137/1 & 5 | |
|---------------|-----------|-------------------------|------------------------------|--------------------------|--------------------------|--|-------------------|
| (V) 85°C | µF | | (See below for part options) | µA at 25°C Max/5 Minimum | % at 25°C 120 Hz Maximum | Military Part Number | KEMET Part Number |
| Rated Voltage | Rated Cap | Case Code/ Case Size | KEMET Part Number | DC Leakage | DF | CX01 & CX05 Capacitors per MIL-PRF-49137/1 & 5 | |
| 25 | 12.0 | D | T322D126(1)025A(2) | 2.4 | 4 | | |
| 25 | 15.0 | D | T322D156(1)025A(2) | 3.0 | 4 | | |
| 25 | 18.0 | E | T322E186(1)025A(2) | 3.6 | 6 | | |
| 25 | 22.0 | E | T322E226(1)025A(2) | 4.4 | 6 | | |
| 25 | 27.0 | E | T322E276(1)025A(2) | 5.4 | 6 | | |
| 25 | 33.0 | E | T322E336(1)025A(2) | 6.6 | 6 | | |
| 25 | 39.0 | E | T322E396(1)025A(2) | 7.9 | 6 | | |
| 25 | 47.0 | E | T322E476(1)025A(2) | 9.4 | 6 | | |
| 25 | 56.0 | F | T322F566(1)025A(2) | 10.0 | 6 | | |
| 25 | 68.0 | F | T322F686(1)025A(2) | 10.0 | 6 | | |
| 35 | 0.1 | A | T322A104(1)035A(2) | 0.5 | 3 | | |
| 35 | 0.12 | A | T322A124(1)035A(2) | 0.5 | 3 | | |
| 35 | 0.15 | A | T322A154(1)035A(2) | 0.5 | 3 | | |
| 35 | 0.18 | A | T322A184(1)035A(2) | 0.5 | 3 | | |
| 35 | 0.22 | A | T322A224(1)035A(2) | 0.5 | 3 | | |
| 35 | 0.27 | A | T322A274(1)035A(2) | 0.5 | 3 | | |
| 35 | 0.33 | A | T322A334(1)035A(2) | 1.0 | 4 | CX05M334(3) | T323A334(3)035AS |
| 35 | 0.39 | A | T322A394(1)035A(2) | 0.5 | 3 | | |
| 35 | 0.47 | A | T322A474(1)035A(2) | 1.0 | 4 | CX05M474(3) | T323A474(3)035AS |
| 35 | 0.47 | B | T322B474(1)035A(2) | 1.0 | 4 | CX01M474(3) | T323B474(3)035AS |
| 35 | 0.56 | B | T322B564(1)035A(2) | 1.0 | 4 | CX01M564(3) | T323B564(3)035AS |
| 35 | 0.68 | B | T322B684(1)035A(2) | 1 | 4 | CX01M684(3) | T323B684(3)035AS |
| 35 | 0.82 | B | T322B824(1)035A(2) | 1 | 4 | CX01M824(3) | T323B824(3)035AS |
| 35 | 1.0 | B | T322B105(1)035A(2) | 1 | 6 | CX01M105(3) | T323B105(3)035AS |
| 35 | 1.2 | B | T322B125(1)035A(2) | 1 | 6 | CX01M125(3) | T323B125(3)035AS |
| 35 | 1.5 | B | T322B155(1)035A(2) | 1 | 6 | CX05M155(3) | T323B155(3)035AS |
| 35 | 1.8 | C | T322C185(1)035A(2) | 0.5 | 3 | | |
| 35 | 2.2 | C | T322C225(1)035A(2) | 0.6 | 3 | | |
| 35 | 2.7 | C | T322C275(1)035A(2) | 0.8 | 3 | | |
| 35 | 3.3 | C | T322C335(1)035A(2) | 1.5 | 6 | CX05M335(3) | T323C335(3)035AS |
| 35 | 3.9 | C | T322C395(1)035A(2) | 1.5 | 6 | CX05M395(3) | T323C395(3)035AS |
| 35 | 4.7 | C | T322C475(1)035A(2) | 1.5 | 6 | CX05M475(3) | T323C475(3)035AS |
| 35 | 5.6 | D | T322C565M035A(2) | 1.6 | 4 | | |
| 35 | 6.8 | D | T322D685(1)035A(2) | 3 | 6 | CX05M685(3) | T323D685(3)035AS |
| 35 | 8.2 | D | T322D825(1)035A(2) | 2.3 | 4 | | |
| 35 | 10.0 | D | T322D106(1)035A(2) | 5 | 8 | CX05M106(3) | T323D106(3)035AS |
| 35 | 12.0 | E | T322E126(1)035A(2) | 3.3 | 4 | | |
| 35 | 15.0 | E | T322E156(1)035A(2) | 4.2 | 6 | | |
| 35 | 18.0 | E | T322E186(1)035A(2) | 5.0 | 6 | | |
| 35 | 22.0 | E | T322E226(1)035A(2) | 6.2 | 6 | | |
| 35 | 27.0 | E | T322E276(1)035A(2) | 7.5 | 6 | | |
| 35 | 33.0 | E | T322E336(1)035A(2) | 9.2 | 6 | | |
| 35 | 39.0 | F | T322F396(1)035A(2) | 10.0 | 6 | | |
| 35 | 47.0 | F | T322F476(1)035A(2) | 10.0 | 6 | | |
| 50 | 0.1 | A | T322A104(1)050A(2) | 1.0 | 4 | CX05N104(3) | T323A104(3)050AS |
| 50 | 0.1 | B | T322B104(1)050A(2) | 1.0 | 4 | CX01N104(3) | T323B104(3)050AS |
| 50 | 0.12 | A | T322A124(1)050A(2) | 0.5 | 3 | | |
| 50 | 0.12 | B | T322B124(1)050A(2) | 1.0 | 4 | CX01N124(3) | T323B124(3)050AS |
| 50 | 0.15 | A | T322A154(1)050A(2) | 1.0 | 4 | CX05N154(3) | T323A154(3)050AS |
| 50 | 0.15 | B | T322B154(1)050A(2) | 1.0 | 4 | CX01N154(3) | T323B154(3)050AS |
| (V) 85°C | µF | | (see below for part options) | µA at 25°C Max/5 Minimum | % at 25°C 120 Hz Maximum | Military Part Number | KEMET Part Number |
| Rated Voltage | Rated Cap | Case Code/ Case Size | KEMET Part Number | DC Leakage | DF | CX01 & CX05 Capacitors per MIL-PRF-49137/1 & 5 | |

(1) To complete KEMET part number, insert M for ±20%, K for ±10% or J for 5%. Designates capacitance tolerance.

(2) To complete KEMET part number, insert T = 100% Matte Tin (Sn) Plated, S = Standard Solder coated (SnPb 5% Pb minimum). Designates termination finish.

(3) To complete MIL-PRF part number, insert M for ± 20%, K for ± 10%. Designates Capacitance tolerance.

(4) To complete MIL-PRF part number, insert 01 for specification sheet /1 or 05 for specification sheet /5.

Table 1 – Ratings & Part Number Reference cont.

| Rated Voltage (V) 85°C | Rated Cap µF | Case Code/ Case Size | KEMET Part Number (See below for part options) | DC Leakage µA at 25°C Max/5 Minimum | DF % at 25°C 120 Hz Maximum | CX01 & CX05 Capacitors per MIL-PRF-49137/1 & 5 | |
|---------------------------|-----------------|-------------------------|---|---|-----------------------------------|--|-------------------|
| | | | | | | Military Part Number | KEMET Part Number |
| Rated Voltage | Rated Cap | Case Code/ Case Size | KEMET Part Number | DC Leakage | DF | CX01 & CX05 Capacitors per MIL-PRF-49137/1 & 5 | |
| 50 | 0.18 | A | T322A184(1)050A(2) | 0.5 | 3 | | |
| 50 | 0.18 | B | T322B184(1)050A(2) | 1.0 | 4 | CX01N184(3) | T323B184(3)050AS |
| 50 | 0.22 | A | T322A224(1)050A(2) | 1.0 | 4 | CX05N224(3) | T323A224(3)050AS |
| 50 | 0.22 | B | T322B224(1)050A(2) | 1.0 | 4 | CX01N224(3) | T323B224(3)050AS |
| 50 | 0.27 | A | T322A274(1)050A(2) | 0.5 | 3 | | |
| 50 | 0.27 | B | T322B274(1)050A(2) | 1.0 | 4 | CX01N274(3) | T323B274(3)050AS |
| 50 | 0.33 | B | T322B334(1)050A(2) | 1.0 | 4 | CX(4)N334(3) | T323B334(3)050AS |
| 50 | 0.39 | B | T322B394(1)050A(2) | 1.0 | 4 | CX01N394(3) | T323B394(3)050AS |
| 50 | 0.47 | B | T322B474(1)050A(2) | 1.0 | 4 | CX05N474(3) | T323B474(3)050AS |
| 50 | 0.56 | B | T322B564(1)050A(2) | 0.5 | 3 | | |
| 50 | 0.68 | B | T322B684(1)050A(2) | 1 | 4 | CX05N684(3) | T323B684(3)050AS |
| 50 | 0.82 | B | T322B824(1)050A(2) | 0.5 | 3 | | |
| 50 | 1.0 | B | T322B105(1)050A(2) | 1 | 4 | CX05N105(3) | T323B105(3)050AS |
| 50 | 1.2 | C | T322C125(1)050A(2) | 0.5 | 3 | | |
| 50 | 1.5 | C | T322C155(1)050A(2) | 1.5 | 6 | CX05N155(3) | T323C155(3)050AS |
| 50 | 1.8 | C | T322C185(1)050A(2) | 0.7 | 4 | | |
| 50 | 2.2 | C | T322C225(1)050A(2) | 1.5 | 6 | CX05N225(3) | T323C225(3)050AS |
| 50 | 2.7 | D | T322D275(1)050A(2) | 1.1 | 4 | | |
| 50 | 3.3 | D | T322D335(1)050A(2) | 2 | 6 | CX05N335(3) | T323D335(3)050AS |
| 50 | 3.9 | D | T322D395(1)050A(2) | 1.6 | 4 | | |
| 50 | 4.7 | D | T322D475(1)050A(2) | 3 | 6 | CX05N475(3) | T323D475(3)050AS |
| 50 | 5.6 | E | T322E565(1)050A(2) | 2.2 | 4 | | |
| 50 | 6.8 | E | T322E685(1)050A(2) | 2.7 | 4 | | |
| 50 | 8.2 | E | T322E825(1)050A(2) | 3.2 | 4 | | |
| 50 | 10.0 | E | T322E106(1)050A(2) | 4.0 | 6 | | |
| 50 | 12.0 | F | T322F126(1)050A(2) | 4.8 | 6 | | |
| 50 | 15.0 | F | T322F156(1)050A(2) | 6.0 | 6 | | |
| 50 | 18.0 | F | T322F186(1)050A(2) | 7.2 | 6 | | |
| 50 | 22.0 | F | T322F226(1)050A(2) | 8.8 | 6 | | |
| 50 | 27.0 | F | T322F276M050A(2) | 8 | 6 | | |
| (V) 85°C | µF | Case Code/ Case Size | (see below for part options) | µA at 25°C Max/5 Minimum | % at 25°C 120 Hz Maximum | Military Part Number | KEMET Part Number |
| Rated Voltage | Rated Cap | | KEMET Part Number | DC Leakage | DF | CX01 & CX05 Capacitors per MIL-PRF-49137/1 & 5 | |

(1) To complete KEMET part number, insert M for ±20%, K for ±10% or J for 5%. Designates capacitance tolerance.
(2) To complete KEMET part number, insert T = 100% Matte Tin (Sn) Plated, S = Standard Solder coated (SnPb 5% Pb minimum). Designates termination finish.
(3) To complete MIL-PRF part number, insert M for ± 20%, K for ± 10%. Designates Capacitance tolerance.
(4) To complete MIL-PRF part number, insert 01 for specification sheet /1 or 05 for specification sheet /5.

Recommended Voltage Derating Guidelines

| | -55°C to 85°C | 85°C to 125°C |
|---|---------------|---------------|
| % Change in Working DC Voltage with Temperature | V_R | 66% of V_R |

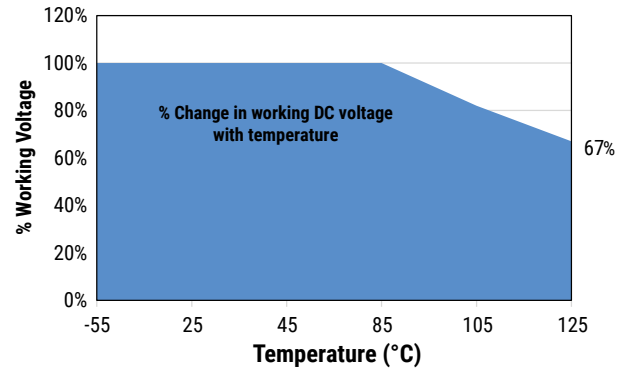

Ripple Current/Ripple Voltage

Permissible AC ripple voltage and current are related to equivalent series resistance (ESR) and the power dissipation capabilities of the device. Permissible AC ripple voltage that may be applied is limited by following criteria:

1. Dissipated power must not exceed the limits specified for the Series.
2. The positive peak AC voltage plus the DC bias voltage, if any, must not exceed the DC voltage rating of the capacitor.
3. The negative peak AC voltage in combination with bias voltage, if any, must not exceed the allowable limits specified for reverse voltage.

Thermal capacities for the various case sizes have been determined empirically and are listed below. The “ripple voltage” permissible may be calculated from the impedance and ESR data shown in the respective product section.

| Temperature Compensation Multipliers for Maximum Power Dissipation | | |
|--|---------------------------|----------------------------|
| $T \leq 25^\circ\text{C}$ | $T \leq 85^\circ\text{C}$ | $T \leq 125^\circ\text{C}$ |
| 1.00 | 0.90 | 0.40 |

T = Environmental Temperature

The maximum power dissipation rating must be reduced with increasing environmental operating temperatures. Refer to the Temperature Compensation Multiplier table for details.

| Case Size | Maximum Power Dissipation (Pmax) Watts at 25°C |
|-----------|--|
| A | 0.060 |
| B | 0.070 |
| C | 0.080 |
| D | 0.090 |
| E | 0.100 |
| F | 0.110 |

Using the P max of the device, the maximum allowable rms ripple current or voltage may be determined.

$$I(max) = \sqrt{P_{max}/R}$$

$$E(max) = Z \sqrt{P_{max}/R}$$

I = rms ripple current (amperes)

E = rms ripple voltage (volts)

P_{max} = maximum power dissipation (watts)

R = ESR at specified frequency (ohms)

Z = Impedance at specified frequency (ohms)

Optimum Solder Wave Profile

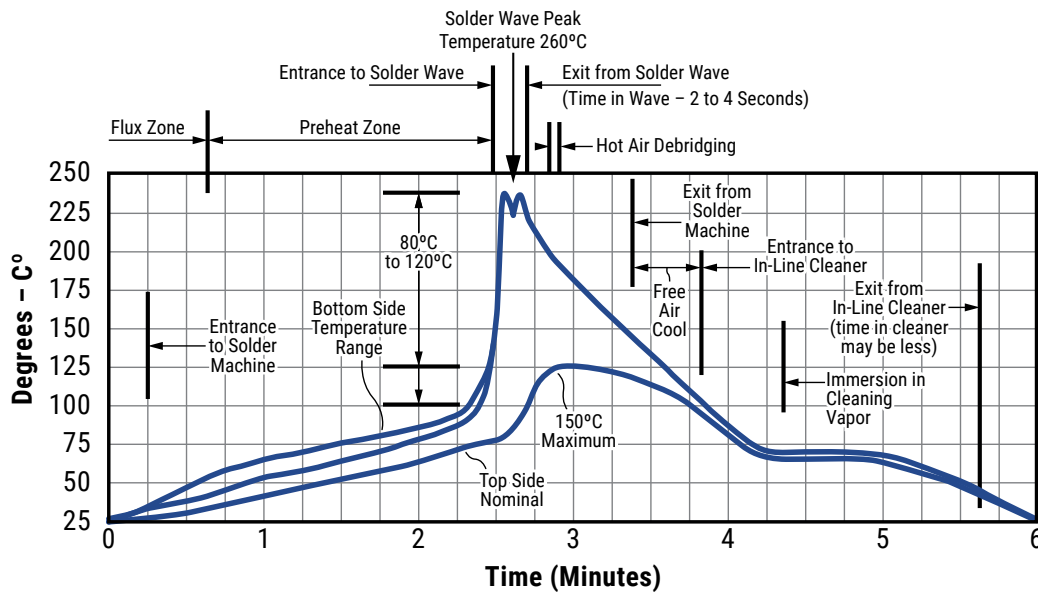

Reverse Voltage

Although these are polar capacitors, some degree of transient voltage reversal is permissible, as seen below. The capacitors should not be operated continuously in reverse mode, even within these limits.

| Temperature (°C) | Percentage of Rated Voltage |
|------------------|-----------------------------|
| +25 | 15 |
| +85 | 5 |
| +125 | 1 |

Construction

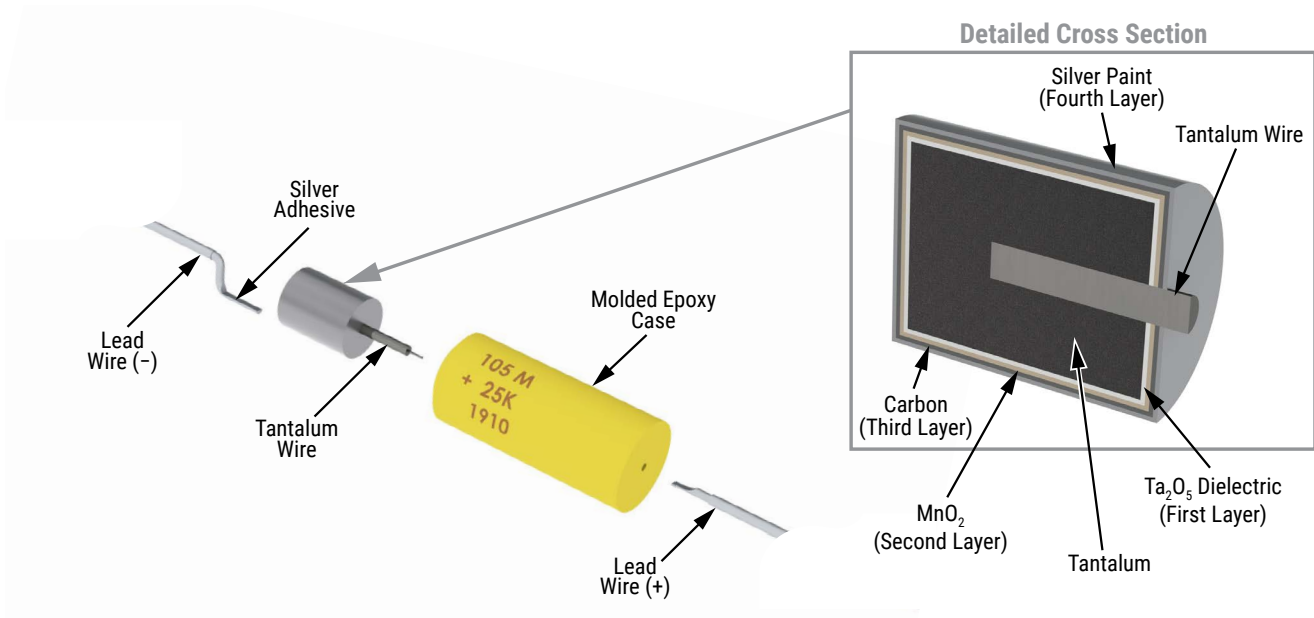

Capacitor Marking

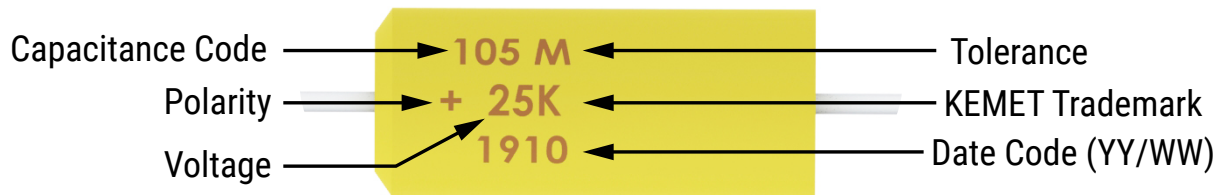

Storage

Tantalum hermetically sealed capacitors should be stored in normal working environments. While the capacitors themselves are quite robust in other environments, solderability will be degraded by exposure to high temperatures, high humidity, corrosive atmospheres, and long term storage. In addition, packaging materials will be degraded by high temperature – reels may soften or warp and tape peel force may increase. KEMET recommends that maximum storage temperature not exceed 40°C and maximum storage humidity not exceed 60% relative humidity. Temperature fluctuations should be minimized to avoid condensation on the parts and atmospheres should be free of chlorine and sulphur bearing compounds. For optimized solderability capacitors stock should be used promptly, preferably within three years of receipt.

Tape & Reel Packaging Information

KEMET offers standard reeling of Solid Tantalum Capacitors for automatic insertion or lead forming machines per EIA Specification RS-296.

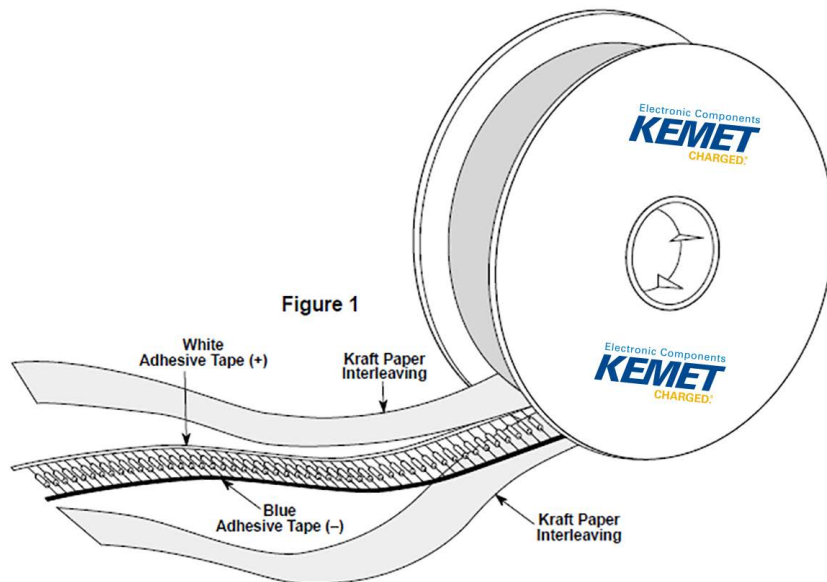

Table 2 – Packaging Quantity

| Case Size | Standard Bulk Quantity | Standard Reel Quantity | Reel C-Spec | Ammo Pack Quantity | Ammo Pack C-Spec |
|-----------|------------------------|------------------------|-------------|--------------------|------------------|
| A | 300 | 4,500 | C-7200 | 2,000 | C-7293 |
| B | 250 | 4,000 | | 2,000 | Class I |
| C | 100 | 2,500 | | 1,000 | C-7442 |
| D | 100 | 2,500 | | 1,000 | Class II |
| E | 100 | 500 | | 250 | C-7443 |
| F | 100 | 500 | | 250 | Class III |

Figure 2

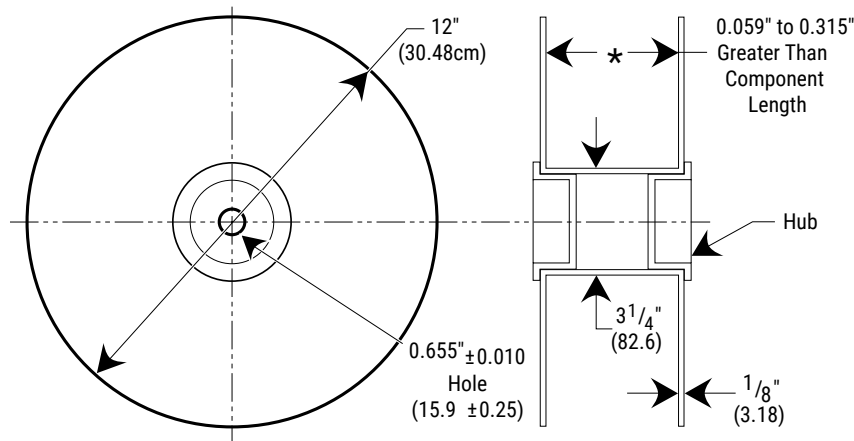

Figure 3

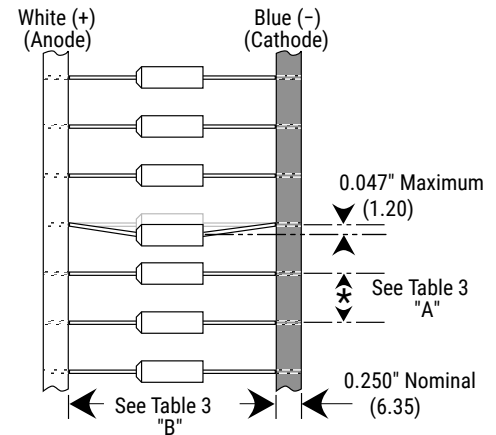

Table 3 – Tape Dimensions

Dimensions in Inches (& Millimeters)

| BODY DIAMETER | A PITCH ±0.020 (0.5) | B INSIDE TAPE SPACING |
|-----------------------------|----------------------------|---|
| ≤ 0.197 (5.0) | 0.200 (5.0) | 2.063 (52.4) +0.079, -0.039 (+2.0, -1.0) |
| 0.198 (5.0) to 0.394 (10.0) | 0.400 or (10.0) | 2.874 (73) +/0.059 |

Capacitors are reeled so that positive leads are oriented as shown in Figure 3. Kraft paper (50 lbs. test minimum) is inserted between the layers of capacitors wound on reels for component pitch ≤ 0.200" sizes and corrugated paper (70 lbs. test minimum), single faced is inserted for component pitch ≥ 0.400" sizes. Capacitor lead length may extend only a maximum of 0.031" (0.8 mm) beyond the tape's edges. Capacitors are centered in a row between the two tapes and will deviate only ±0.031" (0.79 mm) from the row center.

Figures 1 and 2 show the KEMET standard chipboard tape reel.

A minimum of 36" (91.5 cm) leader tape is provided at each end of the reeled capacitors.

Universal splicing clips are used to connect the tape.

KEMET Electronics Corporation Sales Offices

For a complete list of our global sales offices, please visit www.kemet.com/sales.

Disclaimer

YAGEO Corporation and its affiliates do not recommend the use of commercial or automotive grade products for high reliability applications or manned space flight.

All product specifications, statements, information and data (collectively, the "Information") in this datasheet are subject to change. The customer is responsible for checking and verifying the extent to which the Information contained in this publication is applicable to an order at the time the order is placed. All Information given herein is believed to be accurate and reliable, but it is presented without guarantee, warranty, or responsibility of any kind, expressed or implied.

Statements of suitability for certain applications are based on KEMET Electronics Corporation's ("KEMET") knowledge of typical operating conditions for such applications, but are not intended to constitute – and KEMET specifically disclaims – any warranty concerning suitability for a specific customer application or use. The Information is intended for use only by customers who have the requisite experience and capability to determine the correct products for their application. Any technical advice inferred from this Information or otherwise provided by KEMET with reference to the use of KEMET's products is given gratis, and KEMET assumes no obligation or liability for the advice given or results obtained.

Although KEMET designs and manufactures its products to the most stringent quality and safety standards, given the current state of the art, isolated component failures may still occur. Accordingly, customer applications which require a high degree of reliability or safety should employ suitable designs or other safeguards (such as installation of protective circuitry or redundancies) in order to ensure that the failure of an electrical component does not result in a risk of personal injury or property damage.

Although all product-related warnings, cautions and notes must be observed, the customer should not assume that all safety measures are indicated or that other measures may not be required.

KEMET is a registered trademark of KEMET Electronics Corporation.