

AEC-Q200



Construction Wire



### Outline:

- Assemblage design, sturdy structure.
- High inductance, high current, low magnetic loss, low ESR, small parasitic capacitance.
- Flat wire winding, achieve a low D.C. Resistance.
- Low power loss, suitable for applications of wide temperature and frequency range.

### Features:

- Core material: Ferrite
- Core and winding loss: [www.codaca.com/DesignTool\\_Power-Inductor-Loss-Comparison.html](http://www.codaca.com/DesignTool_Power-Inductor-Loss-Comparison.html)
- Environmental: RoHS, Reach compliant, Halogen free
- Weight: 17.21g
- Moisture Sensitivity: Level (MSL) 1 (unlimited floor life at <math><30^{\circ}\text{C}</math> / 85% relative humidity)
- Operating temperature range: - Storage temperature range:

### Application:

- Ideally used in tablet PC, LCD display, server application.
- high current power supplies, Battery power devices
- DC/DC converters in distributed power systems

## 1 Electrical Characteristics

Part No.	Inductance ( $\mu\text{H}$ )※1 $\pm 20\%$	D.C.R. ( $\text{m}\Omega$ )		Isat (A)※2 Typical	Irms (A) ※3 Typical
		Typical	Max.		
CSCF2014-R70MC	0.70	0.66	0.79	75.0	32.0
CSCF2014-1R4MC	1.40	0.86	1.02	60.0	31.5
CSCF2014-2R2MC	2.20	1.32	1.58	52.0	30.5
CSCF2014-3R1MC	3.10	1.92	2.30	45.0	26.0
CSCF2014-4R2MC	4.20	2.54	3.04	38.0	24.0
CSCF2014-5R5MC	5.50	3.30	3.96	33.0	22.0
CSCF2014-7R0MC	7.00	4.25	5.10	30.0	21.0
CSCF2014-8R6MC	8.60	5.90	7.08	25.0	17.0
CSCF2014-100MC	10.0	6.50	7.80	23.0	16.0
CSCF2014-150MC	15.0	7.10	8.50	21.0	14.0
CSCF2014-220MC	22.0	8.60	10.3	15.0	12.5
CSCF2014-330MC	33.0	9.28	11.1	11.0	12.0
CSCF2014-470MC	47.0	10.0	12.0	8.50	11.5

All data is tested on 25°C ambient temperature

1. Inductance measure condition at 100kHz, 0.1V

2. Isat: the actual value of DC current when the inductance decrease 30% of its initial value

3. Irms: the actual value of DC current when the temperature rise is  $\Delta T 40^{\circ}\text{C}$  ( $T_a = 25^{\circ}\text{C}$ )

## 2 Product Dimensions (mm)

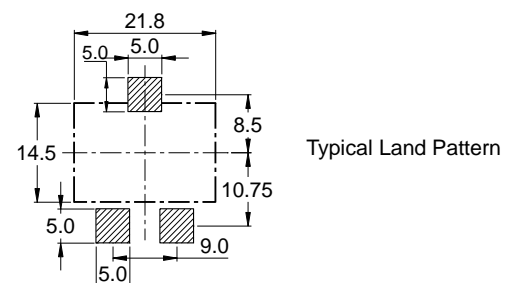
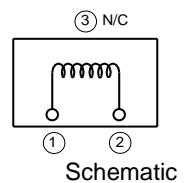
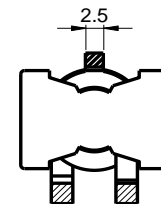
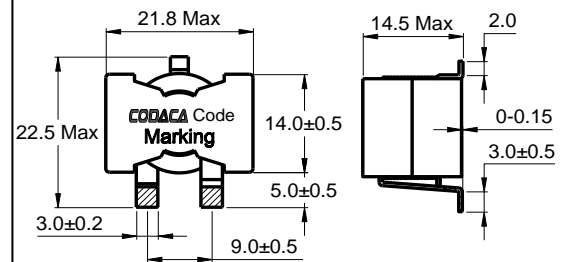

## 3 How to Order:

CSCF2014-470M  
 Model \_\_\_\_\_  
 Dimensions \_\_\_\_\_  
 Value Code \_\_\_\_\_

## 4 Saturation Current vs Temperature Rise Current Curve

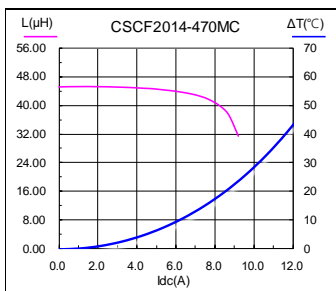
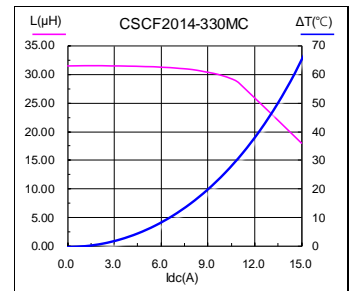
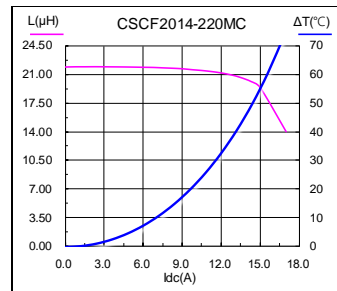
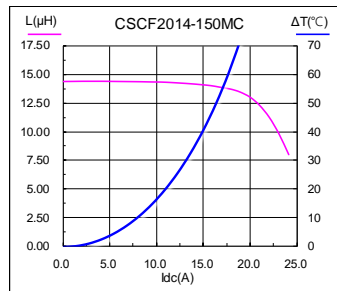
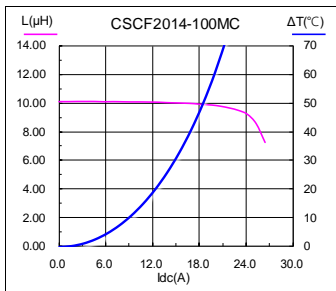
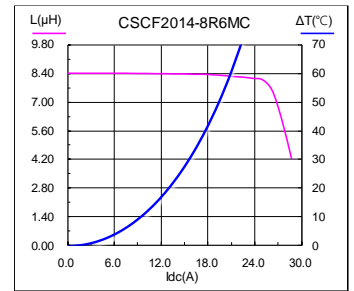
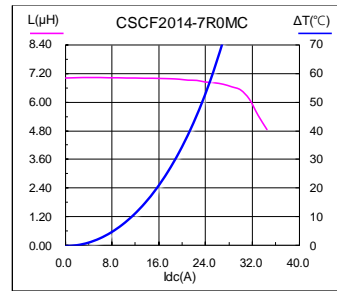
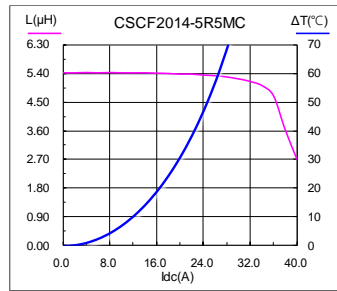
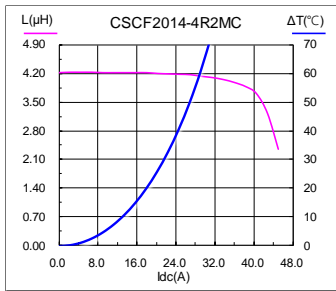
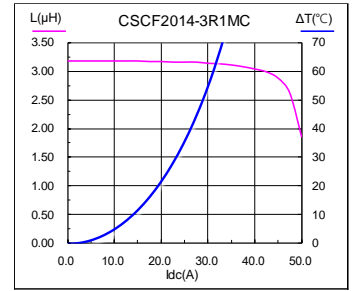
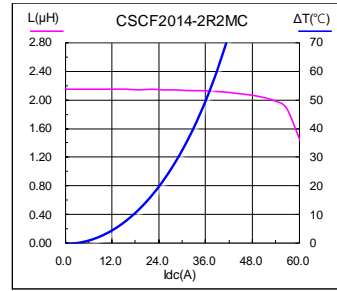
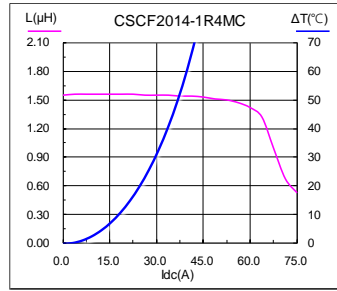
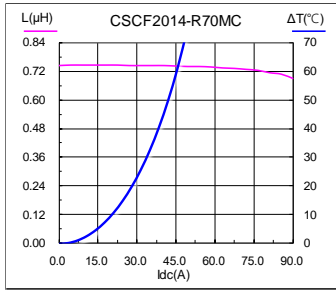

**5 Packing Specification**

**5.1 Carrier Tape Dimensions (mm)**

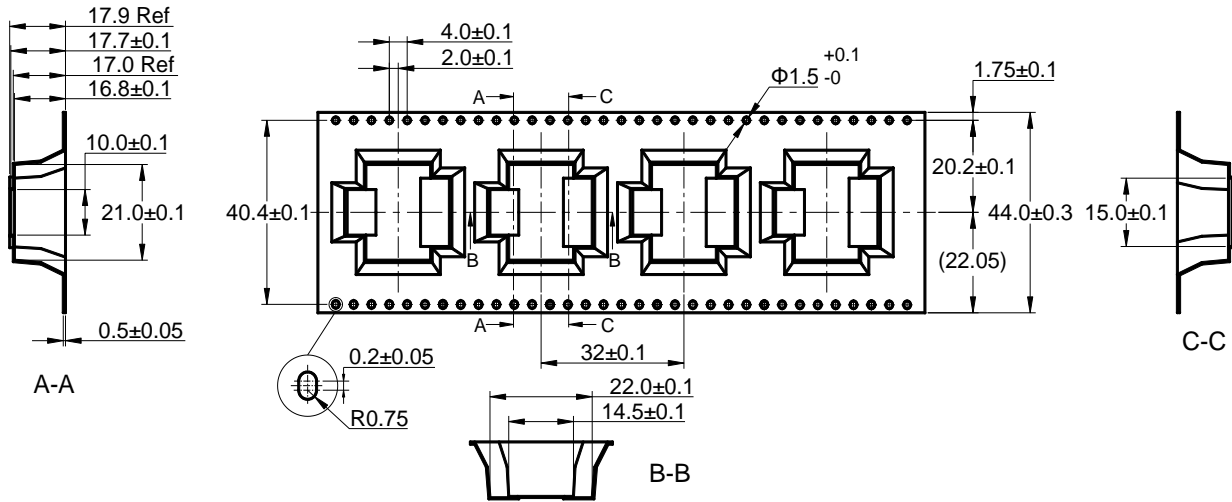

※ Packing is referred to the international standard IEC 60286-3.

**5.2 Reel Dimensions (mm)**

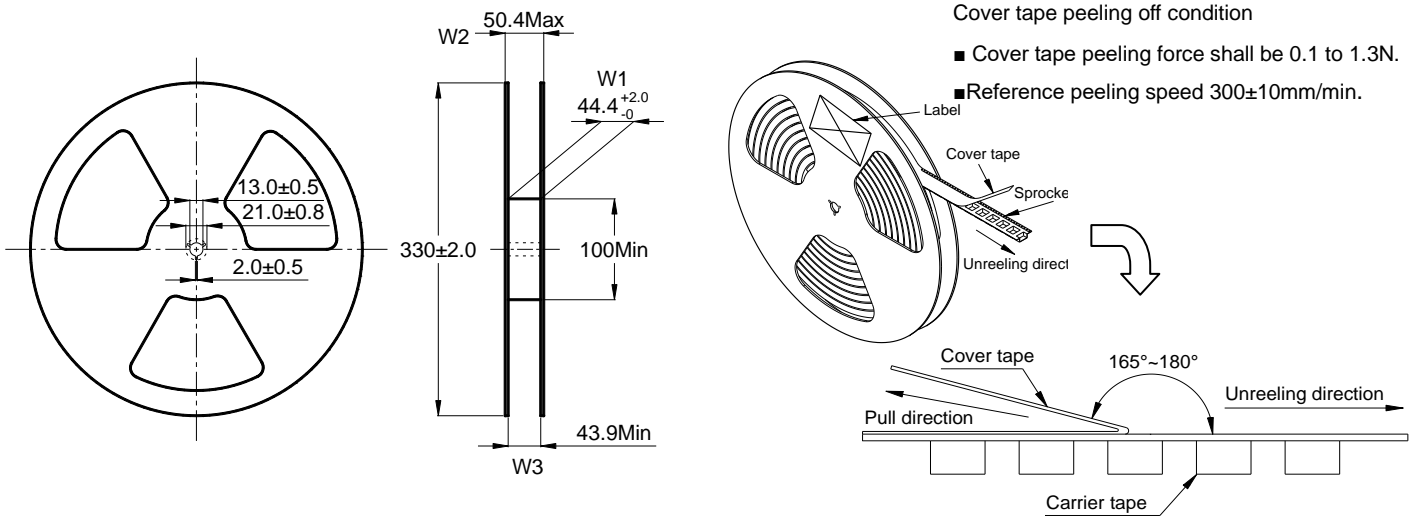

Cover tape peeling off condition  
 ■ Cover tape peeling force shall be 0.1 to 1.3N.  
 ■ Reference peeling speed 300±10mm/min.

**5.3 Carton Dimensions and Packing Quantity**

- Inner Carton: 340×340×135mm
- Out Carton : 360×360×295mm

Product Series	Quantity / Reel	Inner Carton Quantity	Out Carton Quantity
CSCF2014	100pcs	(100×2) = 200pcs	(200×2) = 400pcs

**6 Soldering Specification**

6.1 Reflow Profile for SMT Components

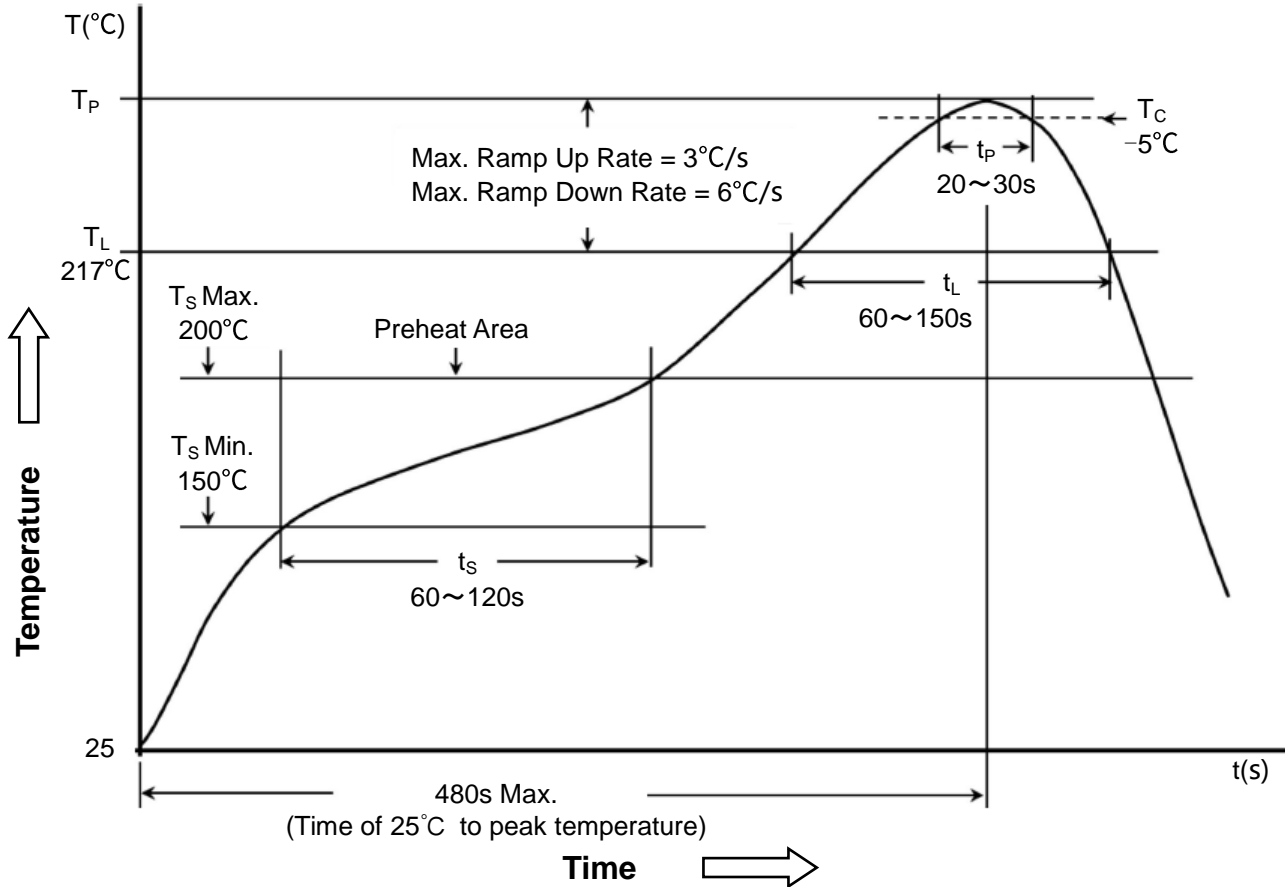

6.2 Classification of Peak Package Body Temperature (Tp)

	Package Thickness	Package Volume		
		<350 mm <sup>3</sup>	350~2000 mm <sup>3</sup>	>2000 mm <sup>3</sup>
PB-Free Assembly	<1.6mm	260°C	260°C	260°C
	1.6~2.5mm	260°C	250°C	245°C
	≥2.5mm	250°C	245°C	245°C

※ Reflow is referred to standard IPC/JEDEC J-STD-020D.

**7 Notice of Use**

- 7.1 Special remind:Circuit design, component placement, PCB size and thickness, cooling system and etc. all will affect the product temperature. Please verify the product temperature in the final application.
- 7.2 Product in packing storage condition: temperature 5~40°C, RH≤70%.  
If taking out for use, the remaining products should be sealed in plastic bags and preserved in accordance with the above conditions, to avoid oxidation of terminals (electrodes), affecting soldering status.
- 7.3 A storage of Codaca Electronic products for longer than 12 months is not recommended, Within other effects, the terminals may suffer degradation, resulting in bad solderability. Therefore, all products shall be used within the period of 12 months based on the day of shipment.
- 7.4 Do not keep products in unsuitable storage conditions, such as areas susceptible to high temperatures, high humidity, dust or corrosion.
- 7.5 Always handle products with care.
- 7.6 Don't touch electrodes directly with bare hands as oil secretions may inhibit soldering.  
Always ensure optimum conditions for soldering.
- 7.7 When this product will be used on a similar or new project to the original one, sometimes it might be unable to satisfy the specifications due to different condition of usage.
- 7.8 This inductor itself does not have any protective function in abnormal condition, such as overload, short-circuit, open-circuit conditions, etc. Therefore, it shall be confirmed that there is no risk of smoke, fire, dielectric withstand voltage, insulation resistance, etc., or use in abnormal conditions protective devices or protection circuit in the end product.
- 7.9 Hi-Pot test with higher voltage than spec value will damage insulating material and shorten its life.
- 7.10 If using in potting compound, the magnet wire coating might be damaged, please consult with us.
- 7.11 Refrain from rinsing coils. If necessary, please consult with us.
- \*7.12 Codaca Electronic products without "V" prefix are qualified for industrial product requirement , and with "V" prefix are qualified for AEC-Q200, but it doesn't mean that Codaca Electronic products can absolutely meet specific industry norms and quality test standards in automotive electronics or more strict application fields . Codaca Electronic will be exempted from being responsible for the consequences of using Codaca products in automotive electronic or higher application field related to safety when without being aware of it.