

# ARTESYN CNS650-M SERIES

650 W AC-DC Power Supplies

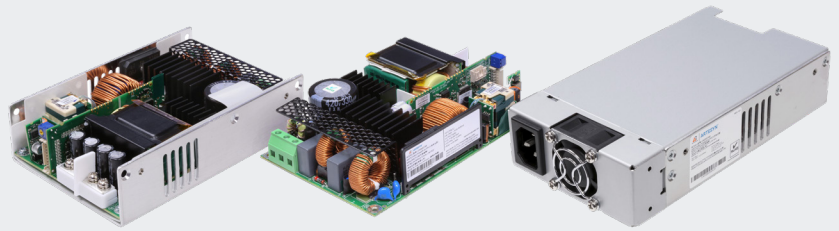

Advanced Energy's Artesyn CNS650-MU series of single output open-frame AC-DC power supplies are offered 12 V, 24 V, or 48 V outputs with +15% trim range. Each power supply comes with a 12 V fan output and 5 V standby. All models feature ITE and medical safety approvals and accept a universal input of 90 to 264 VAC. Depending on operating conditions, its 4" x 6" x 1.54" compact and high density "U-Channel" construction delivers up to 400 W of output power with free air convection cooling and up to 650 W with 400 LFM of forced air. These power supplies are ideal for industrial systems as well as for medical applications.

## SPECIAL FEATURES

- Designed for forced air and natural convection cooling
- Medical and ITE safety approvals, 2x MOPP
- PMBus® interface
- Active current share with OR-ing FET
- Dual fused
- Type BF ready
- Active Power Factor Correction, 61000-3-2 compliant
- Built-in Class B EMI filter
- Less than 1U high
- 4" x 6" U-channel construction (open-frame or end-fan variants available for 12 V)
- <500 mW no-load power consumption
- 80 PLUS® certified (-ME model)
- Three years warranty (consult factory for extended terms)

## SAFETY

- UL+CUL ES 60601-1  
UL 60601-1  
UL 62368-1
- TÜV EN 60601-1
- DEMKO EN 62368-1
- CB IEC 60950-1  
IEC 60601-1  
IEC 62368-1
- CCC GB4943.1/GB9254  
GB17625.1
- CE LVD, RoHS
- UKCA Mark

\*\* CNS650-M tested according to the medical standard IEC 60601-1 3.1 Edition.

## AT A GLANCE

### Total Power:

650 W

### Input Voltage:

90 to 264 VAC

### # of Outputs:

Single



## ELECTRICAL SPECIFICATIONS

Input	
Input voltage range	90 to 264 VAC or 127 to 350 VDC
Frequency	47 to 63 Hz (360 to 400 Hz with higher leakage)
Inrush current	50 Apk, cold start
Leakage current	<300 $\mu$ A (using UL test method)
No load power	< 500 mW
Output	
Maximum power	650 W, forced-air cooling (750 W peak) 400 W, free-air natural convection cooling (650 W peak)
Adjustment range	-0% to +15%
Holdup time	20 ms @ 400 W
Fan output	12 V @ 1.0 A (forced air) 12 V @ 0.5 A (natural convection)
Standby output	5 V @ 2.0 A (forced air) 5 V @ 1.0 A (natural convection)
Control and Protection	
Serial bus interface	PMBus <sup>®</sup>
Current share	Active
Remote sense	2-wire (+ and -)
Remote inhibit	Pull inhibit low = main & fan output OFF (5 V standby is ON) Pull inhibit high (or floating) = all outputs ON
AC OK	Active high when normal AC input is present (with internal 10 kOhm pull up to 3.3 V)
DC OK	Active high when main O/P is within regulation (with internal 10 kOhm pull up to 3.3 V)
Smart fan control	Monitor, control and override
Overvoltage protection	Latch (AC recycle or inhibit toggle required for PSU restart)
Overload protection	Auto-recovery (constant current mode down to 50% Vout)
Overtemperature protection	Auto-recovery with hysteresis

## ENVIRONMENTAL SPECIFICATIONS

Operating temperature	-20 °C to +80 °C (derate at 50 °C), startup at -40 °C
Storage temperature	-40 °C to +85 °C
Operating humidity	5% to 95% (non-condensing)
Non-operating humidity	5% to 95% (non-condensing)
Maximum altitude	5000 m (3000 m for medical), derating may apply

## OTHER SPECIFICATIONS

Isolation	4000 VAC (input to output) 1500 VAC (input to PE, output to PE)
Line harmonics	EN 61000-3-2, Class A
ESD immunity	EN 61000-4-2, ±15kV (air) / ±8kV (contact) - Criterion A
Conducted EMI	Level B, CISPR 22 and FCC Part 15
Radiated EMI	Level B, CISPR 22 and FCC Part 15 (with cover)
Surge immunity	EN 61000-4-5, Level 3 - Criterion A, Level 4 - Criterion C
Medical EMC	EN 60601-1-2: 2014 (cover maybe required for some tests)
MTBF (Telcordia, Issue 3, Method 1, Case 3)	> 950 KHrs, 25 °C, 410 W natural convection > 1.3 MHrs, 25 °C, 650 W forced air

## ORDERING INFORMATION

Model Number	Output Voltage	Vout Adjust Range (-0% / +15%)	Minimum Load	Max. Continuous Load (Free Air)	Max. Peak Load (Free Air) <sup>1</sup>	Max. Continuous Load (Forced Air) <sup>2</sup>	Max. Peak Load (Forced Air) <sup>2</sup>	Regulation <sup>3</sup>	Ripple (p-p) <sup>4</sup>
CNS653-ME <sup>5,6</sup>	12 V	12 - 13.8 V	0 A	54.2 A	62.5 A	NA	NA	±2%	120 mV
CNS653-MF <sup>5</sup>	12 V	12 - 13.8 V	0 A	30.8 A	54.2 A	54.2 A	62.5 A	±2%	120 mV
CNS653-MU	12 V	12 - 13.8 V	0 A	33.3 A	54.2 A	54.2 A	62.5 A	±2%	120 mV
CNS655-MU	24 V	24 - 27.6 V	0 A	16.7 A	27.1 A	27.1 A	31.3 A	±2%	240 mV
CNS658-MU	48 V	48 - 55.2 V	0 A	8.3 A	13.5 A	13.5 A	15.6 A	±2%	480 mV

<sup>1</sup> Peak load current not to exceed 10 seconds, Ta = 50 °C.

<sup>2</sup> Requires at least 400 LFM of airflow.

<sup>3</sup> At 25 °C including factory setpoint, line voltage and load current variations.

<sup>4</sup> Peak-to-peak ripple measured at the output terminal with 20 MHz bandwidth and 10 µF (tantalum capacitor) in parallel with 0.1 µF capacitor across the output.

<sup>5</sup> Optional suffix "-ME" (end-fan) and "-MF" (open-frame) available on the 12 V output.

<sup>6</sup> 80 PLUS certified.

### INPUT CONNECTIONS (-MU AND -MF SUFFIX)

Pin	Function	Power Supply Side	System Side
TB1	PE	Dinkle EHK762V-03P Max Torque: 4kgf-cm	Recommended Wire Size: AWG #22 to #14
TB2	L2/Neutral		
TB3	L1/Line		

### INPUT CONNECTIONS (-ME SUFFIX)

Pin	Function	Power Supply Side	System Side
IEC Inlet	Input AC	IEC 60320 C14 (Male)	IEC Cord C13 (Female)

### OUTPUT CONNECTIONS

Pin	Function	Power Supply Side	System Side
BAR1	-Vout	Output Terminal Screw: M4X8 (4X) Max Torque: 10kgf-cm	Molex 19099-0032 or 19141-0063 for AWG #16 to #14 Molex 19099-0048 or 19141-0083 for AWG #12 to #10
BAR2	-Vout		
BAR3	+Vout		
BAR4	+Vout		

## OTHER OUTPUT AND CONTROL CONNECTIONS (CONNECTOR J304)

Pin	Designation	Description	
1	5VSB	+5 V Standby Output	J304 20-Pin Connector (PSU Side):
2	5VSB	+5 V Standby Output	Landwin: 2052P20008T or
3	5VSB_GND	+5 V Standby Output Return/Ground	CviLux: CI0120P1HD0-LF
4	SCL	Serial Clock Signal (I2C)	
5	A0	EEPROM Address	Recommended Mating Connectors:
6	SDA	Serial Data Signal (I2C)	CviLux: CI0120SD000 (housing)
7	I_SHARE	Active Current Share	CI01TD21PE0 (contact pins)
8	SYS_GND	Return Ground for Signals and I2C	Landwin: 2050S2000 (housing)
9	12VFAN	12 V Fan Output	2053T021V (contact pins)
10	REMOTE INHIBIT	Output Inhibit Pin (Main Output)	JST: PHDR-20VS (housing)
11	FAN_RTN	12 V Fan Output Return/Ground	SPHD-001T-P0.5 (contact pins)
12	VIN_GOOD	Input Line OK Signal	
13	FAN_PWM1	FAN PWM	
14	PWOK	Output Power OK Signal	See ACCESSORIES Section
15	FAN_TACH1	Fan1 Tacho Signal	
16	FAN_OVERRIDE	External Fan Sensor for Override	
17	FAN_FAIL	Fain Fail Signal	
18	FAN_FAULT_EN	FAN Fault Enable Due to Low RPM	
19	REMOTE_SENSE+	Positive Remote Sense	
20	REMOTE_SENSE-	Remote Sense Return	

## FAN OUTPUT CONNECTOR FOR -MU, -MF SUFFIX (CONNECTOR J306)

Pin	Function	Description	
1	12VFAN	12 V fan output	J306 4-Pin Connector (PSU Side):
2	FAN_RTN	12 V fan return	CviLux: CI0104P1HK0-LF
3	FAN_PWM1	Fan PWM	Landwin: 2003P0401V
4	FAN_TACH1	Fan1 tacho signal	Recommended Mating Connectors:
			CviLux: CI0104S0000 (housing)
			CviLux: CI01T01MPP0 (contact pins)
			Landwin: 2001S0400 (housing)
			Landwin: 2005T011R (contact pins)

MECHANICAL DRAWINGS (“-MU” SUFFIX FOR U-BASE CONSTRUCTION/12 V, 24 V AND 48 V)

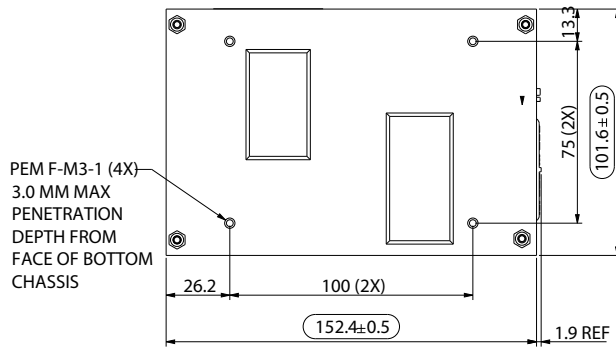
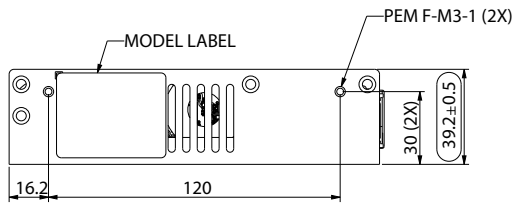
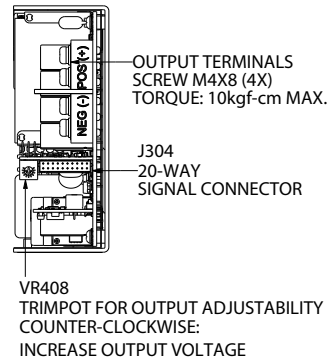
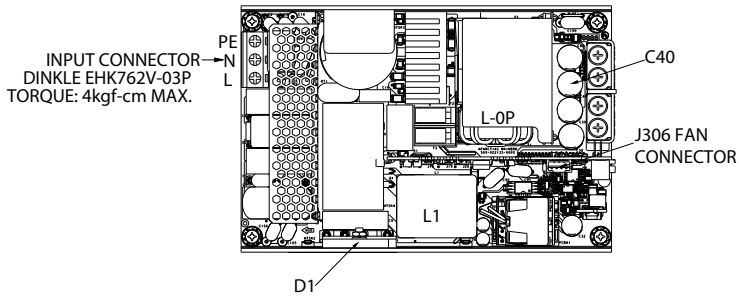
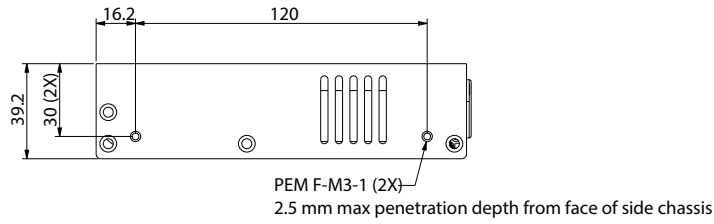

Thermal Hot Spot Reference	
Component	Temperature Limit (-MU)
D1 (AC bridge diode)	105 °C
L1 (PFC choke)	115 °C
C40 (output cap)	100 °C
L-output (output choke)	125 °C
Do not exceed indicated temperature limits to ensure operation is within the component thermal derating limits. Measure the component temperatures using K type thermocouples.	

Unit weight (-MU suffix): 800 g

MECHANICAL DRAWINGS (“-MF” SUFFIX FOR OPEN-FRAME CONSTRUCTION/12 V ONLY)

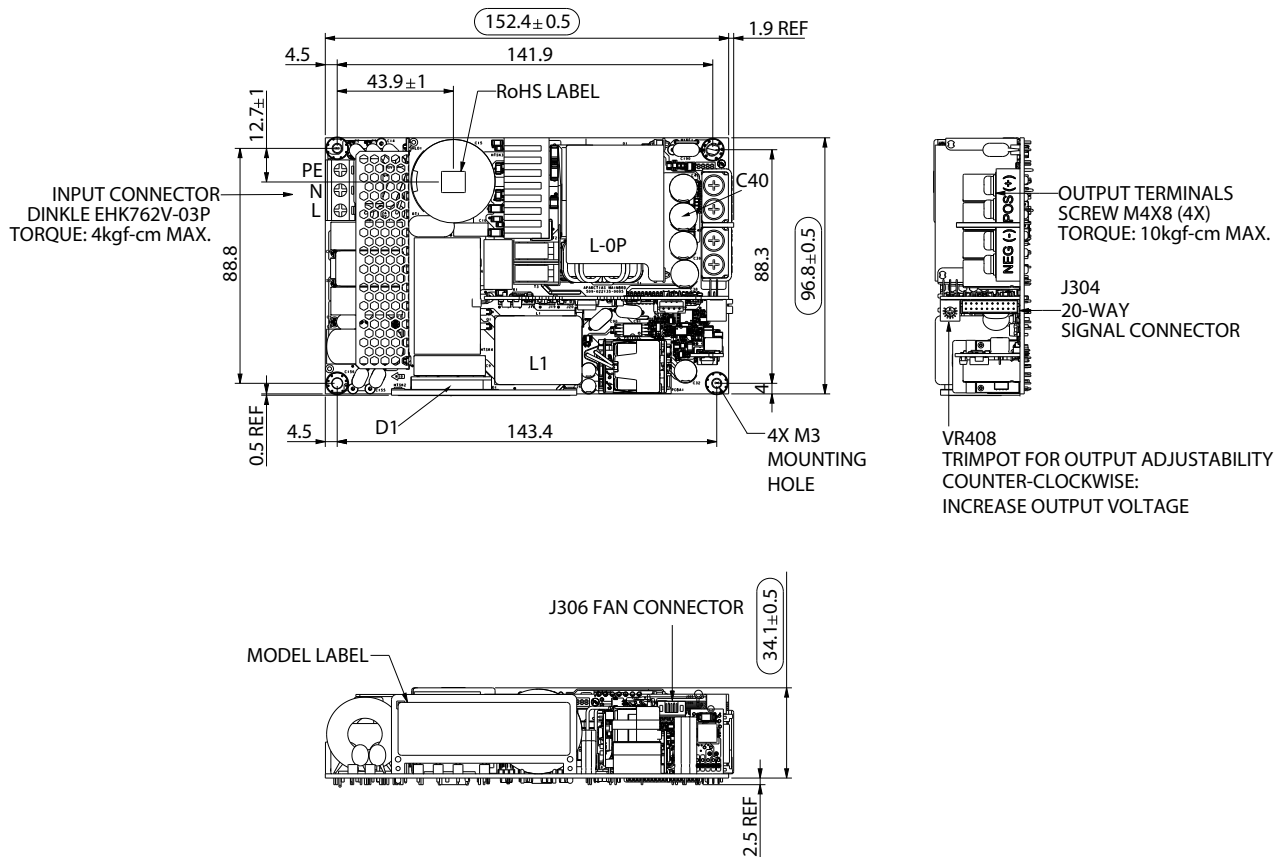

Thermal Hot Spot Reference	
Component	Temperature Limit (-MF)
D1 (AC bridge diode)	120 °C
L1 (PFC choke)	120°C
C40 (output cap)	100 °C
L-output (output choke)	125 °C
Do not exceed indicated temperature limits to ensure operation is within the component thermal derating limits. Measure the component temperatures using K type thermocouples.	

Unit weight (-MF suffix): 650 g

MECHANICAL DRAWINGS (“-ME” SUFFIX FOR END-FAN CONSTRUCTION/12 V ONLY)

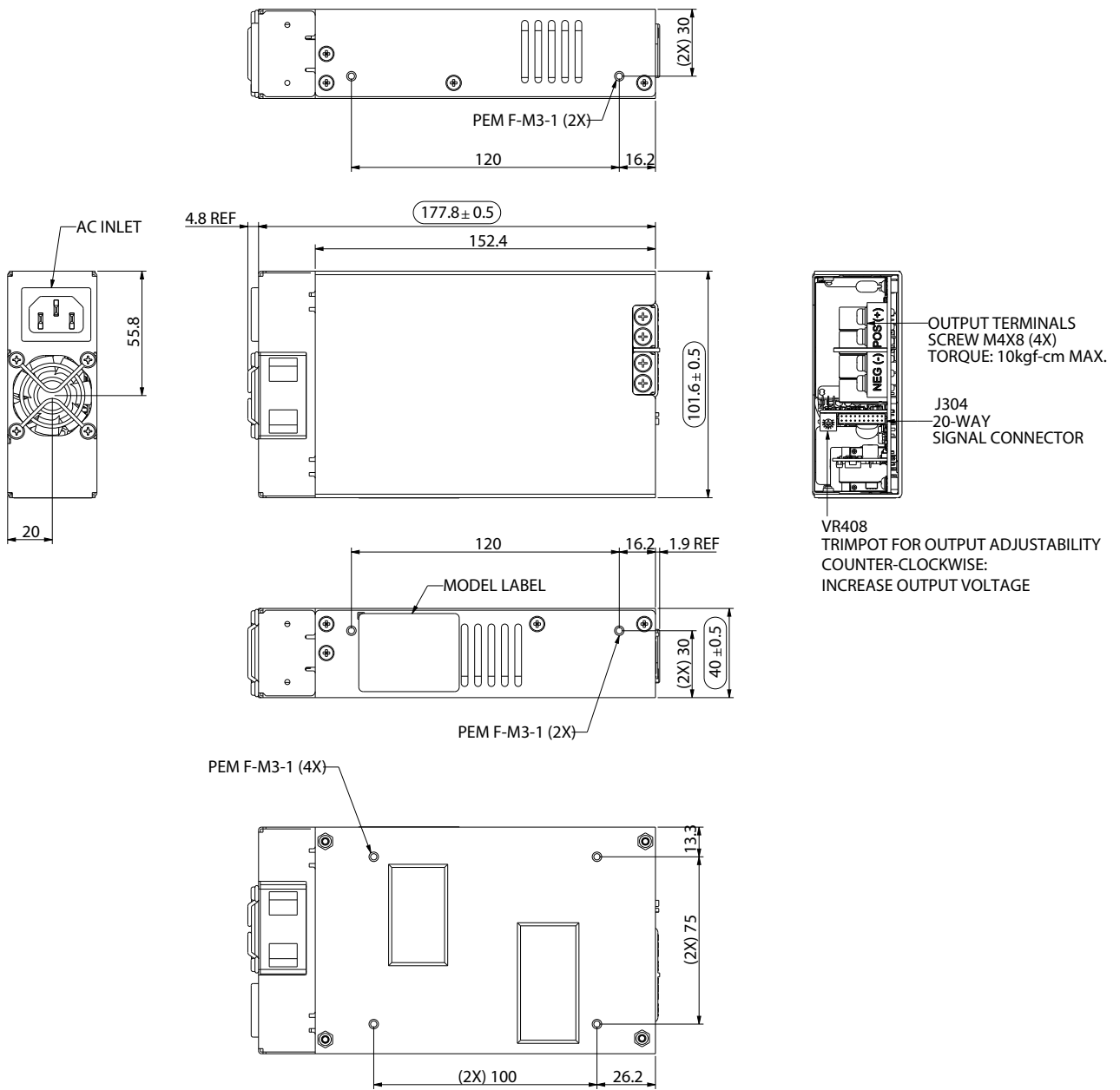



PERFORMANCE CURVES

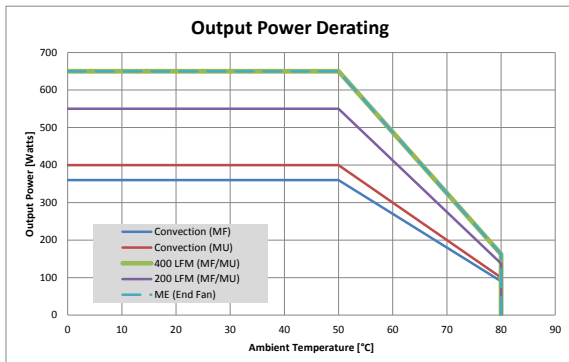

Figure 1. Output Power vs. Ambient Temperature at Natural Convection and Forced Air Cooling

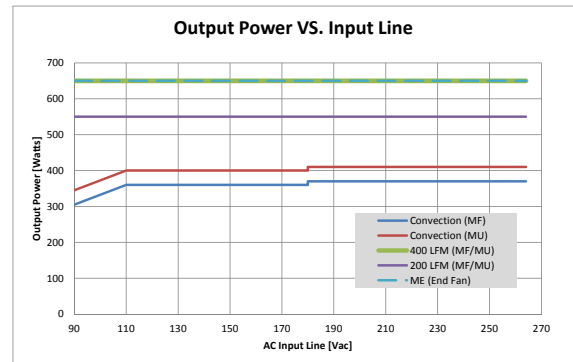

Figure 2. Output Power vs. Input Line at Natural Convection and Forced Air Cooling

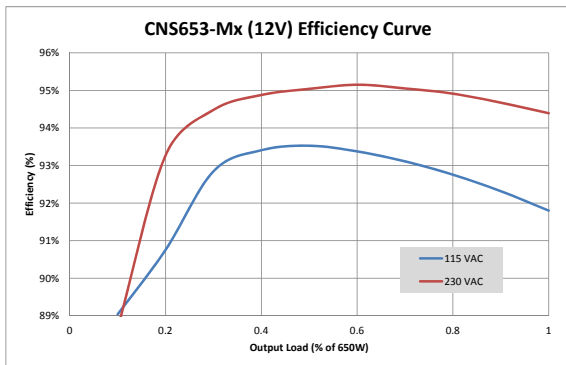

Figure 3. Typical Efficiency for 12 V Output

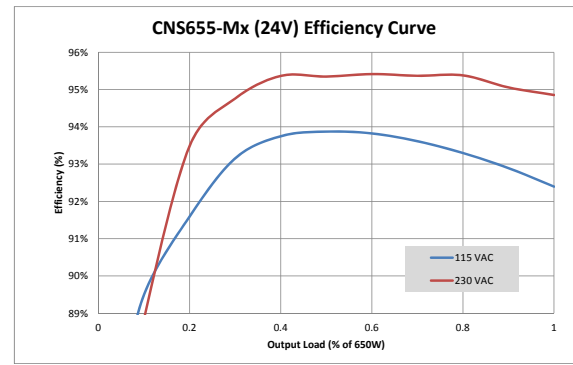

Figure 4. Typical Efficiency for 24 V Output

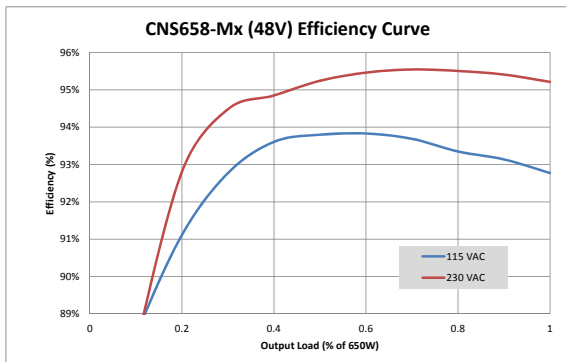

Figure 5. Typical Efficiency for 48 V Output

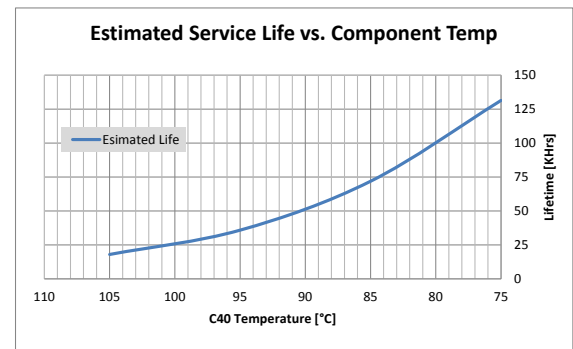

Figure 6. Estimated Product Useful Life Based on C40 Case Temperature

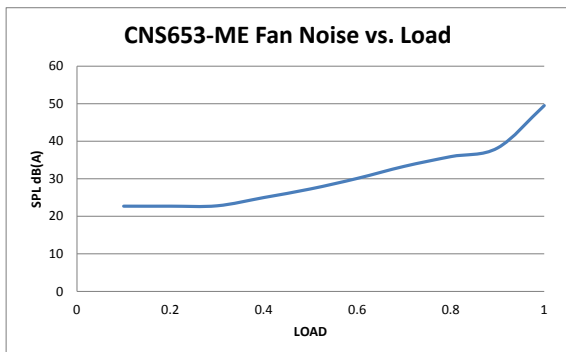
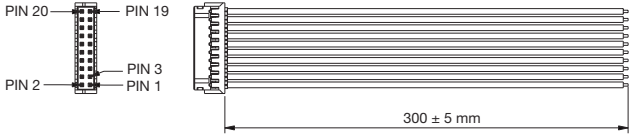
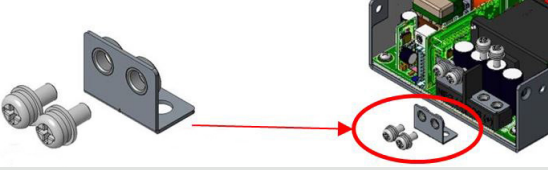



Figure 7. CNS653-ME (End Fan) Typical Audible Noise Level vs. Output Load at 90 VAC, -30 °C Ambient.

ACCESSORIES

Orderable Part Number	Description	Description
73-788-001	J304 (20 Pin) Mating Connector with 0.3 m wires attached	
CNS-BBAR-KIT	Output Bussbar Extension Kit for Vertical Wire Interface	
73-769-002	USB to I <sup>2</sup> C Adaptor for PMBus Communication	



For international contact information,  
visit [advancedenergy.com](https://www.advancedenergy.com).

[powersales@aei.com](mailto:powersales@aei.com) (Sales Support)  
[productsupport.ep@aei.com](mailto:productsupport.ep@aei.com) (Technical Support)  
+1 888 412 7832

## ABOUT ADVANCED ENERGY

Advanced Energy (AE) has devoted more than three decades to perfecting power for its global customers. AE designs and manufactures highly engineered, precision power conversion, measurement and control solutions for mission-critical applications and processes.

Our products enable customer innovation in complex applications for a wide range of industries including semiconductor equipment, industrial, manufacturing, telecommunications, data center computing, and medical. With deep applications know-how and responsive service and support across the globe, we build collaborative partnerships to meet rapid technological developments, propel growth for our customers, and innovate the future of power.

**PRECISION | POWER | PERFORMANCE | TRUST**

---

Specifications are subject to change without notice. Not responsible for errors or omissions. ©2023 Advanced Energy Industries, Inc. All rights reserved. Advanced Energy®, and AE® are U.S. trademarks of Advanced Energy Industries, Inc.