

OSRAM KW DSLP31.CC

Datasheet

Published by **ams-OSRAM AG**

Tobelbader Strasse 30, 8141 Premstaetten, Austria

Phone +43 3136 500-0

ams-osram.com

© All rights reserved



OSTUNE® E3030

KW DSLP31.CC specified at 60 mA



The OSTUNE® E3030 KW DSLP31.CC is specifically designed for automotive interior high quality white applications, offering a color temperature range from 2700 K (warm white) to 6500 K (cold white) at a superior CRI level.



Applications

- Ambient Lighting
- Automotive Aftermarket

Features

- Package: white SMT package, colored diffused silicone resin
- Chip technology: InGaN on Sapphire
- Color: $C_x = 0.40$, $C_y = 0.38$ acc. to CIE 1931 (● white)
- Corrosion Robustness Class: 3B
- Qualifications: AEC-Q102 Qualified
- Color temperature: 2700K - 6500K
- CRI: 90 (min.)
- ESD: 2 kV acc. to ANSI/ESDA/JEDEC JS-001 (HBM, Class 2)

Ordering Information

Type	Color temperature	Luminous Flux ¹⁾ $I_F = 60 \text{ mA}$ Φ_V	Ordering Code
KW DSLP31.CC-GXHX-4U9X-Z444	2700 K	18 ... 33 lm	Q65112A9871
KW DSLP31.CC-GXHX-4R9T-Z444	3000 K	18 ... 33 lm	Q65112A9872
KW DSLP31.CC-GXHX-4O9Q-Z444	3500 K	18 ... 33 lm	Q65112A9870
KW DSLP31.CC-GXHX-4L8N-Z444	4000 K	18 ... 33 lm	Q65113A1208
KW DSLP31.CC-GXHX-4J8K-Z444	4500 K	18 ... 33 lm	Q65113A1210
KW DSLP31.CC-GXHX-4H8I-Z444	5000 K	18 ... 33 lm	Q65112A9868
KW DSLP31.CC-GXHX-4F8G-Z444	5700 K	18 ... 33 lm	Q65112A9869
KW DSLP31.CC-GXHX-4C8E-Z444	6500 K	18 ... 33 lm	Q65112A9867

Maximum Ratings

Parameter	Symbol		Values
Operating Temperature	T_{op}	min.	-40 °C
		max.	110 °C
Storage Temperature	T_{stg}	min.	-40 °C
		max.	110 °C
Junction Temperature	T_j	max.	125 °C
Junction Temperature for short time applications*	T_j	max.	135 °C
Forward current $T_s = 25\text{ °C}$	I_F	min.	3 mA
		max.	200 mA
Forward current pulsed $t \leq 5\text{ ms}$; $D = 10\%$; $T_s = 25\text{ °C}$	$I_{F\text{ pulse}}$	max.	400 mA
Reverse voltage ²⁾ $T_s = 25\text{ °C}$	V_R	max.	5 V
ESD withstand voltage acc. to ANSI/ESDA/JEDEC JS-001 (HBM, Class 2)	V_{ESD}		2 kV

* The median lifetime (L70/B50) for $T_j = 135\text{ °C}$ is 100h.

Characteristics

$I_F = 60 \text{ mA}$; $T_S = 25 \text{ °C}$

Parameter	Symbol		Values
Chromaticity Coordinate ³⁾	C_x	typ.	0.40
	C_y	typ.	0.38
Forward Voltage ⁴⁾ $I_F = 60 \text{ mA}$	V_F	min.	2.70 V
		typ.	2.90 V
		max.	3.10 V
Reverse current ²⁾ $V_R = 5 \text{ V}$	I_R	typ.	0.01 μA
		max.	10 μA
Color Rendering Index	CRI	min.	90
Real thermal resistance junction/solderpoint ⁵⁾	$R_{\text{thJS real}}$	typ.	26 K / W
		max.	36 K / W

Brightness Groups

Group	Luminous Flux ¹⁾ $I_F = 60 \text{ mA}$ min. Φ_V	Luminous Flux ¹⁾ $I_F = 60 \text{ mA}$ max. Φ_V
GX	18 lm	21 lm
GY	21 lm	24 lm
GZ	24 lm	28 lm
HX	28 lm	33 lm

Forward Voltage Groups

Group	Forward Voltage ⁴⁾ $I_F = 60 \text{ mA}$ min. V_F	Forward Voltage ⁴⁾ $I_F = 60 \text{ mA}$ max. V_F
Z4	2.70 V	2.90 V
44	2.90 V	3.10 V

Chromaticity Coordinate Groups

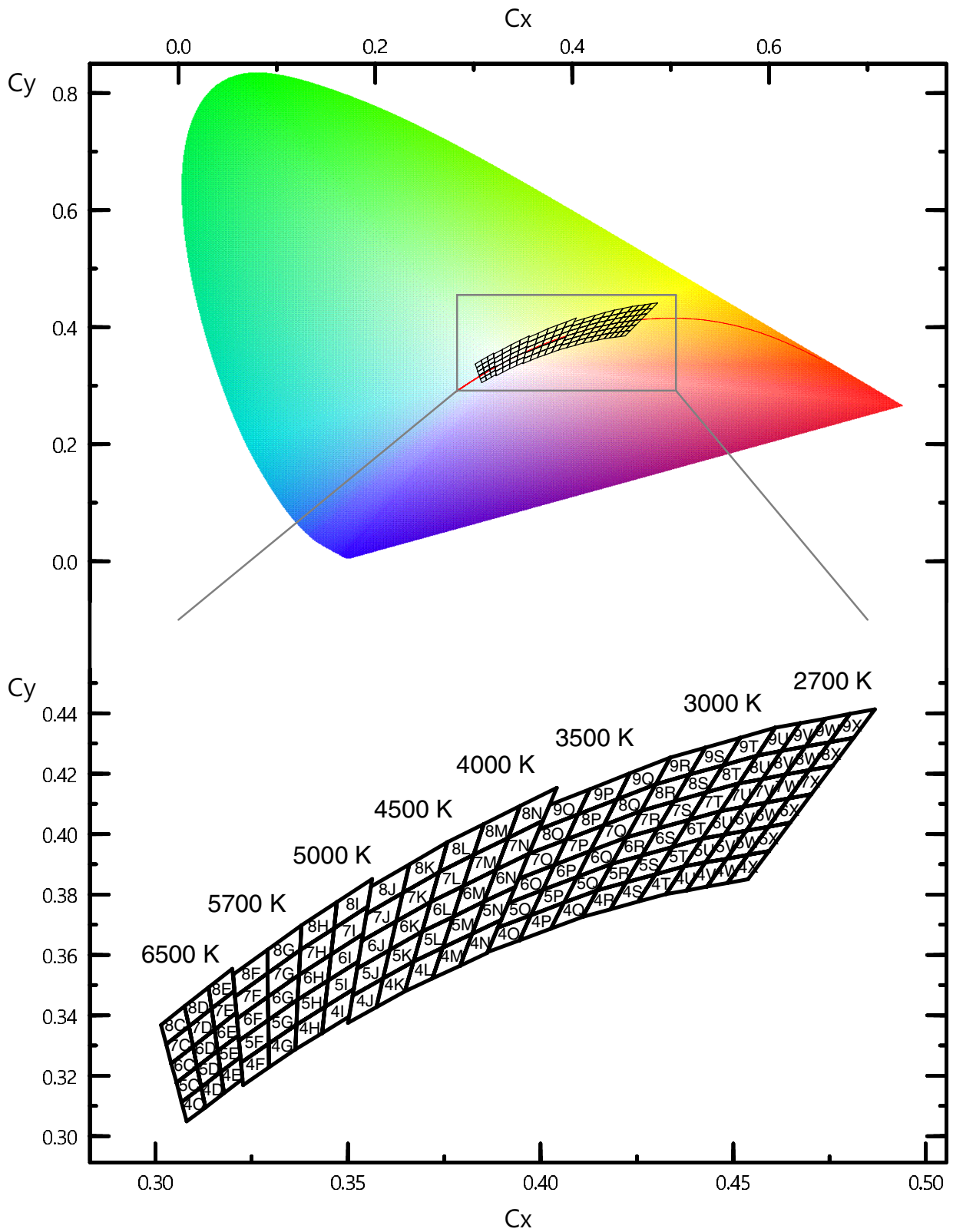

Chromaticity Coordinate Groups ³⁾

Group	Cx	Cy	Group	Cx	Cy	Group	Cx	Cy
8P	0.4067	0.3982	5W	0.4483	0.3919	7W	0.4585	0.4104
	0.4097	0.4065		0.4534	0.4011		0.4636	0.4197
	0.4198	0.4115		0.4591	0.4025		0.4697	0.4211
	0.4164	0.4029		0.4538	0.3931		0.4644	0.4118
8Q	0.4164	0.4029	5X	0.4538	0.3931	7X	0.4644	0.4118
	0.4198	0.4115		0.4591	0.4025		0.4697	0.4211
	0.4299	0.4165		0.4648	0.4038		0.4758	0.4225
	0.4261	0.4077		0.4593	0.3944		0.4703	0.4132
4U	0.4326	0.3801	6U	0.4420	0.3985	8U	0.4515	0.4168
	0.4373	0.3893		0.4468	0.4077		0.4562	0.4260
	0.4428	0.3906		0.4526	0.4090		0.4625	0.4275
	0.4379	0.3814		0.4477	0.3998		0.4576	0.4183
4V	0.4379	0.3814	6V	0.4477	0.3998	8V	0.4576	0.4183
	0.4428	0.3906		0.4526	0.4090		0.4625	0.4275
	0.4483	0.3919		0.4585	0.4104		0.4688	0.4290
	0.4432	0.3826		0.4534	0.4011		0.4636	0.4197
4W	0.4432	0.3826	6W	0.4534	0.4011	8W	0.4636	0.4197
	0.4483	0.3919		0.4585	0.4104		0.4688	0.4290
	0.4538	0.3931		0.4644	0.4118		0.4750	0.4304
	0.4485	0.3838		0.4591	0.4025		0.4697	0.4211
4X	0.4485	0.3838	6X	0.4591	0.4025	8X	0.4697	0.4211
	0.4538	0.3931		0.4644	0.4118		0.4750	0.4304
	0.4593	0.3944		0.4703	0.4132		0.4813	0.4319
	0.4538	0.3850		0.4648	0.4038		0.4758	0.4225
5U	0.4373	0.3893	7U	0.4468	0.4077	9U	0.4562	0.4260
	0.4420	0.3985		0.4515	0.4168		0.4609	0.4352
	0.4477	0.3998		0.4576	0.4183		0.4674	0.4367
	0.4428	0.3906		0.4526	0.4090		0.4625	0.4275
5V	0.4428	0.3906	7V	0.4526	0.4090	9V	0.4625	0.4275
	0.4477	0.3998		0.4576	0.4183		0.4674	0.4367
	0.4534	0.4011		0.4636	0.4197		0.4739	0.4382
	0.4483	0.3919		0.4585	0.4104		0.4688	0.4290

Group	Cx	Cy	Group	Cx	Cy	Group	Cx	Cy
9W	0.4688	0.4290	6R	0.4185	0.3902	8T	0.4430	0.4138
	0.4739	0.4382		0.4223	0.3990		0.4474	0.4228
	0.4803	0.4398		0.4305	0.4019		0.4562	0.4260
	0.4750	0.4304		0.4263	0.3929		0.4515	0.4168
9X	0.4750	0.4304	6S	0.4263	0.3929	9R	0.4299	0.4165
	0.4803	0.4398		0.4305	0.4019		0.4337	0.4253
	0.4868	0.4413		0.4386	0.4048		0.4428	0.4286
	0.4813	0.4319		0.4342	0.3957		0.4387	0.4197
4R	0.4109	0.3726	6T	0.4342	0.3957	9S	0.4387	0.4197
	0.4147	0.3814		0.4386	0.4048		0.4428	0.4286
	0.4222	0.3840		0.4468	0.4077		0.4519	0.4319
	0.4181	0.3751		0.4420	0.3985		0.4474	0.4228
4S	0.4181	0.3751	7R	0.4223	0.3990	9T	0.4474	0.4228
	0.4222	0.3840		0.4261	0.4077		0.4519	0.4319
	0.4298	0.3867		0.4346	0.4108		0.4609	0.4352
	0.4254	0.3776		0.4305	0.4019		0.4562	0.4260
4T	0.4254	0.3776	7S	0.4305	0.4019	4O	0.3863	0.3609
	0.4298	0.3867		0.4346	0.4108		0.3890	0.3690
	0.4373	0.3893		0.4430	0.4138		0.3975	0.3731
	0.4326	0.3801		0.4386	0.4048		0.3945	0.3648
5R	0.4147	0.3814	7T	0.4386	0.4048	4P	0.3945	0.3648
	0.4185	0.3902		0.4430	0.4138		0.3975	0.3731
	0.4263	0.3929		0.4515	0.4168		0.4061	0.3773
	0.4222	0.3840		0.4468	0.4077		0.4027	0.3687
5S	0.4222	0.3840	8R	0.4261	0.4077	4Q	0.4027	0.3687
	0.4263	0.3929		0.4299	0.4165		0.4061	0.3773
	0.4342	0.3957		0.4387	0.4197		0.4147	0.3814
	0.4298	0.3867		0.4346	0.4108		0.4109	0.3726
5T	0.4298	0.3867	8S	0.4346	0.4108	5O	0.3890	0.3690
	0.4342	0.3957		0.4387	0.4197		0.3916	0.3772
	0.4420	0.3985		0.4474	0.4228		0.4006	0.3815
	0.4373	0.3893		0.4430	0.4138		0.3975	0.3731

Group	Cx	Cy	Group	Cx	Cy	Group	Cx	Cy
5P	0.3975	0.3731	8O	0.3970	0.3934	5M	0.3746	0.3624
	0.4006	0.3815		0.3997	0.4015		0.3773	0.3726
	0.4095	0.3858		0.4097	0.4065		0.3853	0.3776
	0.4061	0.3773		0.4067	0.3982		0.3822	0.3670
5Q	0.4061	0.3773	9O	0.3997	0.4015	5N	0.3822	0.3670
	0.4095	0.3858		0.4023	0.4097		0.3853	0.3776
	0.4185	0.3902		0.4128	0.4148		0.3934	0.3825
	0.4147	0.3814		0.4097	0.4065		0.3898	0.3716
6O	0.3916	0.3772	9P	0.4097	0.4065	6L	0.3692	0.3677
	0.3943	0.3853		0.4128	0.4148		0.3714	0.3775
	0.4036	0.3898		0.4232	0.4201		0.3799	0.3828
	0.4006	0.3815		0.4198	0.4115		0.3773	0.3726
6P	0.4006	0.3815	9Q	0.4198	0.4115	6M	0.3773	0.3726
	0.4036	0.3898		0.4232	0.4201		0.3799	0.3828
	0.4130	0.3944		0.4337	0.4253		0.3885	0.3882
	0.4095	0.3858		0.4299	0.4165		0.3853	0.3776
6Q	0.4095	0.3858	4L	0.3648	0.3479	6N	0.3853	0.3776
	0.4130	0.3944		0.3670	0.3578		0.3885	0.3882
	0.4223	0.3990		0.3746	0.3624		0.3970	0.3935
	0.4185	0.3902		0.3719	0.3522		0.3934	0.3825
7O	0.3943	0.3853	4M	0.3719	0.3522	7L	0.3714	0.3775
	0.3970	0.3934		0.3746	0.3624		0.3736	0.3874
	0.4067	0.3982		0.3822	0.3670		0.3826	0.3931
	0.4036	0.3898		0.3791	0.3564		0.3799	0.3828
7P	0.4036	0.3898	4N	0.3791	0.3564	7M	0.3799	0.3828
	0.4067	0.3982		0.3822	0.3670		0.3826	0.3931
	0.4164	0.4029		0.3898	0.3716		0.3916	0.3987
	0.4130	0.3944		0.3862	0.3607		0.3885	0.3882
7Q	0.4130	0.3944	5L	0.3670	0.3578	7N	0.3885	0.3882
	0.4164	0.4029		0.3692	0.3677		0.3916	0.3987
	0.4261	0.4077		0.3773	0.3726		0.4006	0.4044
	0.4223	0.3990		0.3746	0.3624		0.3970	0.3935

Group	Cx	Cy	Group	Cx	Cy	Group	Cx	Cy
8L	0.3736	0.3874	6K	0.3608	0.3616	5I	0.3441	0.3428
	0.3758	0.3973		0.3625	0.3711		0.3448	0.3515
	0.3853	0.4033		0.3714	0.3775		0.3527	0.3578
	0.3826	0.3931		0.3692	0.3677		0.3515	0.3487
8M	0.3826	0.3931	7J	0.3536	0.3646	6H	0.3369	0.3451
	0.3853	0.4033		0.3548	0.3736		0.3373	0.3534
	0.3947	0.4093		0.3642	0.3805		0.3456	0.3601
	0.3916	0.3987		0.3625	0.3711		0.3448	0.3515
8N	0.3916	0.3987	7K	0.3625	0.3711	6I	0.3448	0.3515
	0.3947	0.4093		0.3642	0.3805		0.3456	0.3601
	0.4042	0.4153		0.3736	0.3874		0.3539	0.3669
	0.4006	0.4044		0.3714	0.3775		0.3527	0.3578
4J	0.3500	0.3375	8J	0.3548	0.3736	7H	0.3373	0.3534
	0.3512	0.3465		0.3560	0.3826		0.3376	0.3616
	0.3591	0.3522		0.3659	0.3900		0.3464	0.3688
	0.3574	0.3427		0.3642	0.3805		0.3456	0.3601
4K	0.3574	0.3427	8K	0.3642	0.3805	7I	0.3456	0.3601
	0.3591	0.3522		0.3659	0.3900		0.3464	0.3688
	0.3670	0.3578		0.3758	0.3973		0.3551	0.3760
	0.3648	0.3479		0.3736	0.3874		0.3539	0.3669
5J	0.3512	0.3465	4H	0.3363	0.3287	8H	0.3376	0.3616
	0.3524	0.3555		0.3366	0.3369		0.3379	0.3698
	0.3608	0.3616		0.3441	0.3428		0.3471	0.3775
	0.3591	0.3522		0.3433	0.3341		0.3464	0.3688
5K	0.3591	0.3522	4I	0.3433	0.3341	8I	0.3464	0.3688
	0.3608	0.3616		0.3441	0.3428		0.3471	0.3775
	0.3692	0.3677		0.3515	0.3487		0.3563	0.3851
	0.3670	0.3578		0.3503	0.3396		0.3551	0.3760
6J	0.3524	0.3555	5H	0.3366	0.3369	4F	0.3228	0.3170
	0.3536	0.3646		0.3369	0.3451		0.3222	0.3243
	0.3625	0.3711		0.3448	0.3515		0.3294	0.3306
	0.3608	0.3616		0.3441	0.3428		0.3295	0.3228

Group	Cx	Cy	Group	Cx	Cy	Group	Cx	Cy
4G	0.3295	0.3228	8G	0.3292	0.3539	6D	0.3108	0.3229
	0.3294	0.3306		0.3291	0.3617		0.3098	0.3296
	0.3366	0.3369		0.3379	0.3698		0.3154	0.3352
	0.3363	0.3287		0.3376	0.3616		0.3162	0.3282
5F	0.3222	0.3243	4C	0.3081	0.3049	6E	0.3162	0.3282
	0.3217	0.3316		0.3068	0.3113		0.3154	0.3352
	0.3293	0.3384		0.3119	0.3162		0.3210	0.3408
	0.3294	0.3306		0.3130	0.3095		0.3216	0.3334
5G	0.3294	0.3306	4D	0.3130	0.3095	7C	0.3041	0.3240
	0.3293	0.3384		0.3119	0.3162		0.3028	0.3304
	0.3369	0.3451		0.3170	0.3212		0.3087	0.3363
	0.3366	0.3369		0.3178	0.3142		0.3098	0.3296
6F	0.3217	0.3316	4E	0.3178	0.3142	7D	0.3098	0.3296
	0.3212	0.3389		0.3170	0.3212		0.3087	0.3363
	0.3292	0.3461		0.3221	0.3262		0.3146	0.3422
	0.3293	0.3384		0.3226	0.3189		0.3154	0.3352
6G	0.3293	0.3384	5C	0.3068	0.3113	7E	0.3154	0.3352
	0.3292	0.3461		0.3055	0.3177		0.3146	0.3422
	0.3373	0.3534		0.3108	0.3229		0.3205	0.3481
	0.3369	0.3451		0.3119	0.3162		0.3210	0.3408
7F	0.3212	0.3389	5D	0.3119	0.3162	8C	0.3028	0.3304
	0.3206	0.3462		0.3108	0.3229		0.3015	0.3368
	0.3292	0.3539		0.3162	0.3282		0.3076	0.3430
	0.3292	0.3461		0.3170	0.3212		0.3087	0.3363
7G	0.3292	0.3461	5E	0.3170	0.3212	8D	0.3087	0.3363
	0.3292	0.3539		0.3162	0.3282		0.3076	0.3430
	0.3376	0.3616		0.3216	0.3334		0.3138	0.3492
	0.3373	0.3534		0.3221	0.3262		0.3146	0.3422
8F	0.3206	0.3462	6C	0.3055	0.3177	8E	0.3146	0.3422
	0.3201	0.3534		0.3041	0.3240		0.3138	0.3492
	0.3291	0.3617		0.3098	0.3296		0.3200	0.3554
	0.3292	0.3539		0.3108	0.3229		0.3205	0.3481

Group Name on Label

Example: GX-4C-44

Brightness

Color Chromaticity

Forward Voltage

GX

4C

44

Relative Spectral Emission ⁶⁾

$\Phi_{rel} = f(\lambda); I_F = 60 \text{ mA}; T_S = 25 \text{ }^\circ\text{C}$

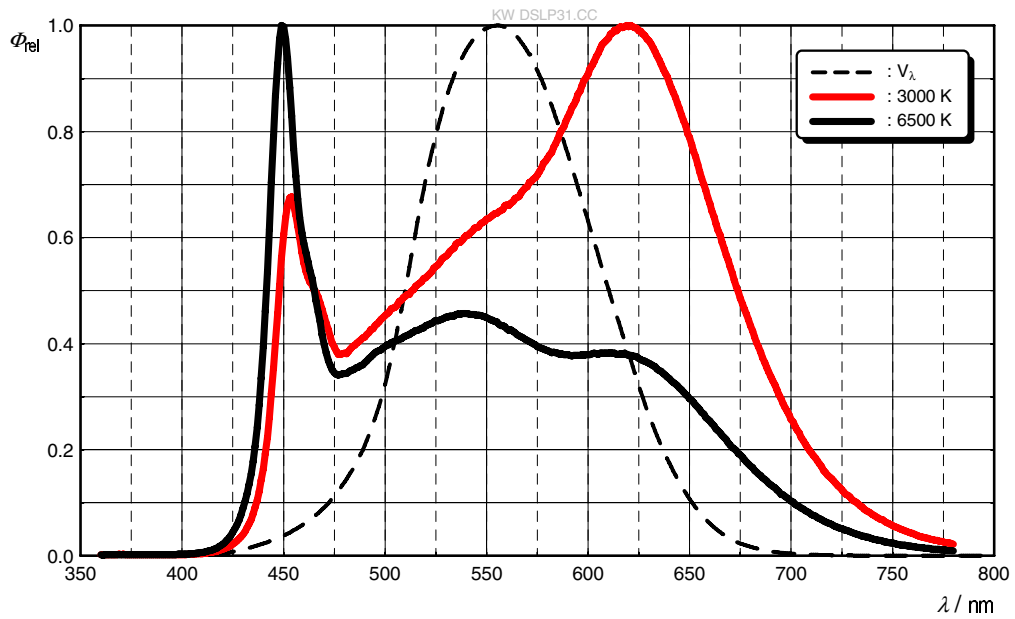

Radiation Characteristics ⁶⁾

$I_{rel} = f(\phi); T_S = 25 \text{ }^\circ\text{C}$

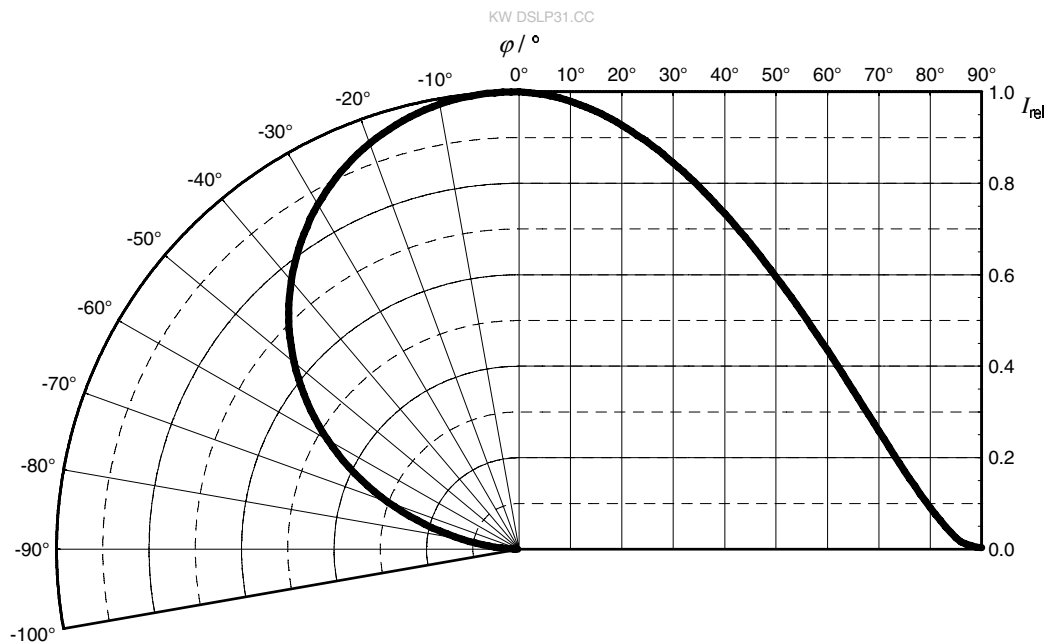

Forward current ⁶⁾

$$I_F = f(V_F); T_S = 25\text{ °C}$$

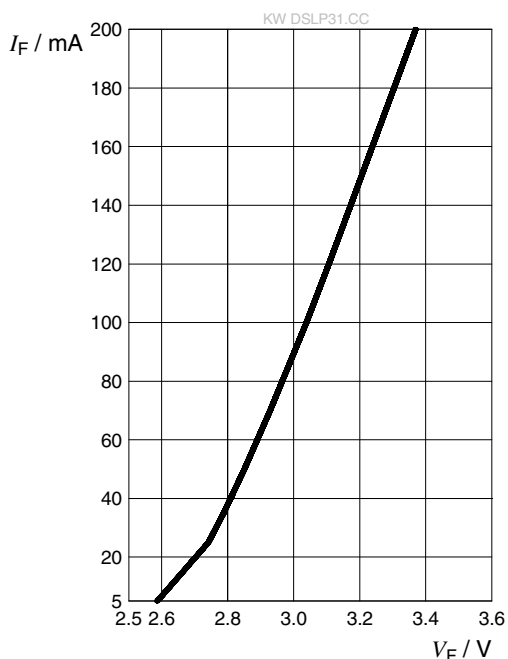

Relative Luminous Flux ^{6), 7)}

$$\Phi_V / \Phi_V(60\text{ mA}) = f(I_F); T_S = 25\text{ °C}$$

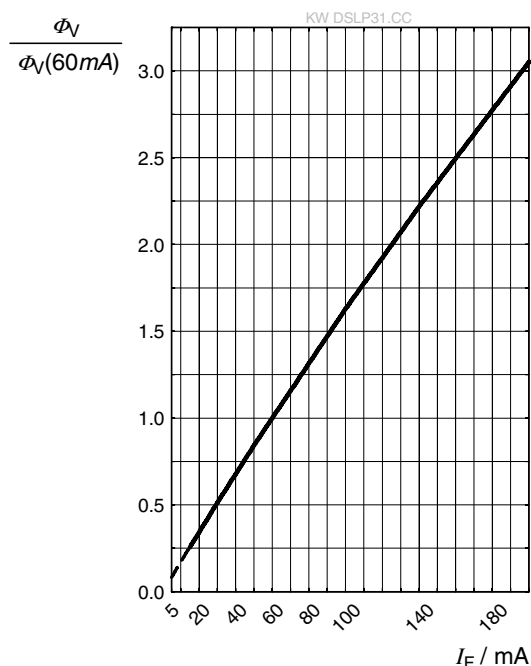

Chromaticity Coordinate Shift ⁶⁾

$$\Delta Cx, \Delta Cy = f(I_F); T_S = 25\text{ °C}$$

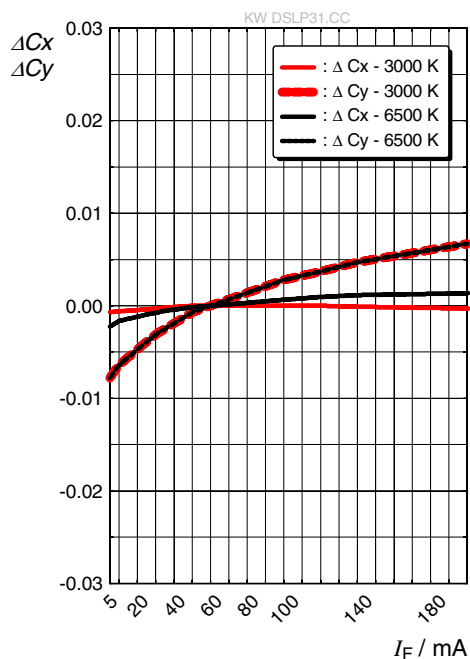

Forward Voltage ⁶⁾

$$\Delta V_F = V_F - V_F(25^\circ\text{C}) = f(T_j); I_F = 60\text{ mA}$$

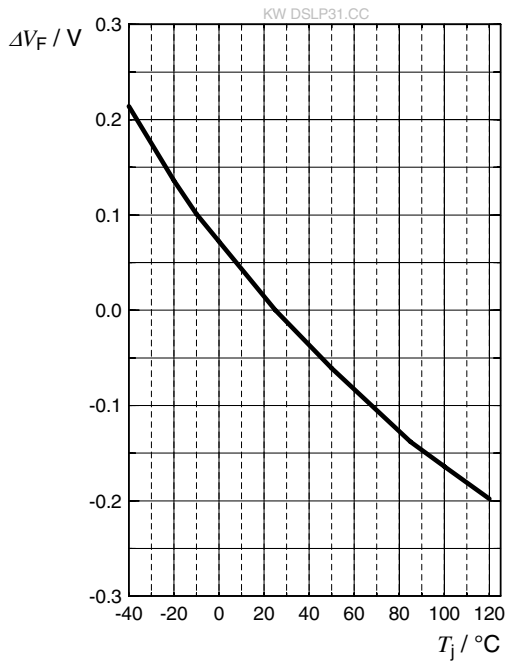

Relative Luminous Flux ⁶⁾

$$\Phi_v / \Phi_v(25^\circ\text{C}) = f(T_j); I_F = 60\text{ mA}$$

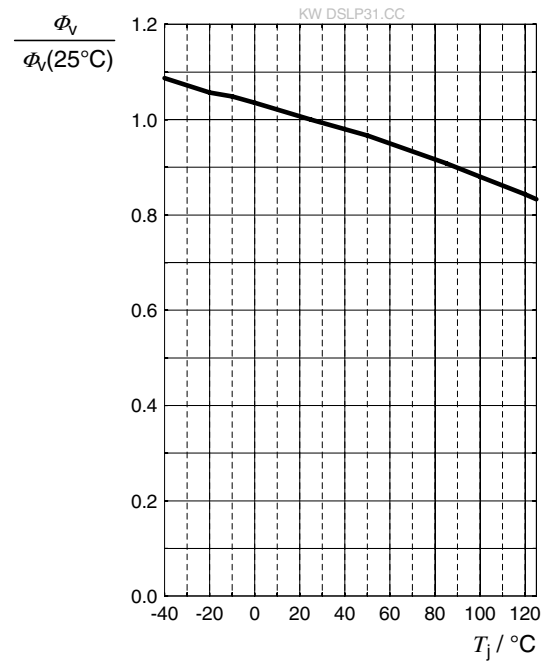

Chromaticity Coordinate Shift ⁶⁾

$$\Delta Cx, \Delta Cy = f(T_j); I_F = 60\text{ mA}$$

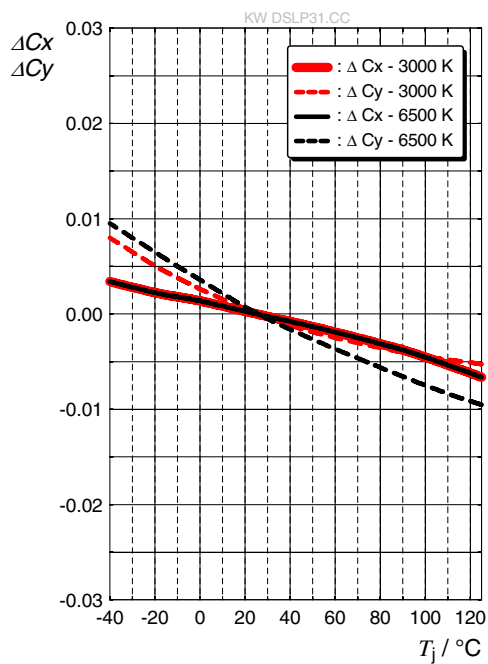

Max. Permissible Forward Current

$$I_F = f(T)$$

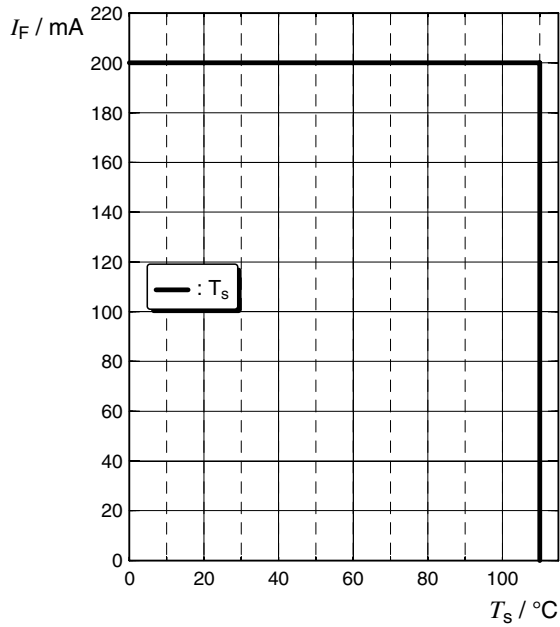

Permissible Pulse Handling Capability

$$I_F = f(t_p); D: \text{Duty cycle}$$

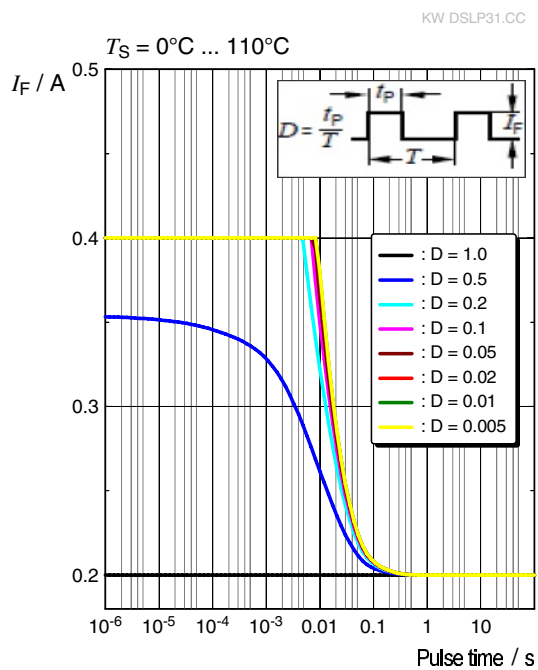

Dimensional Drawing ⁸⁾

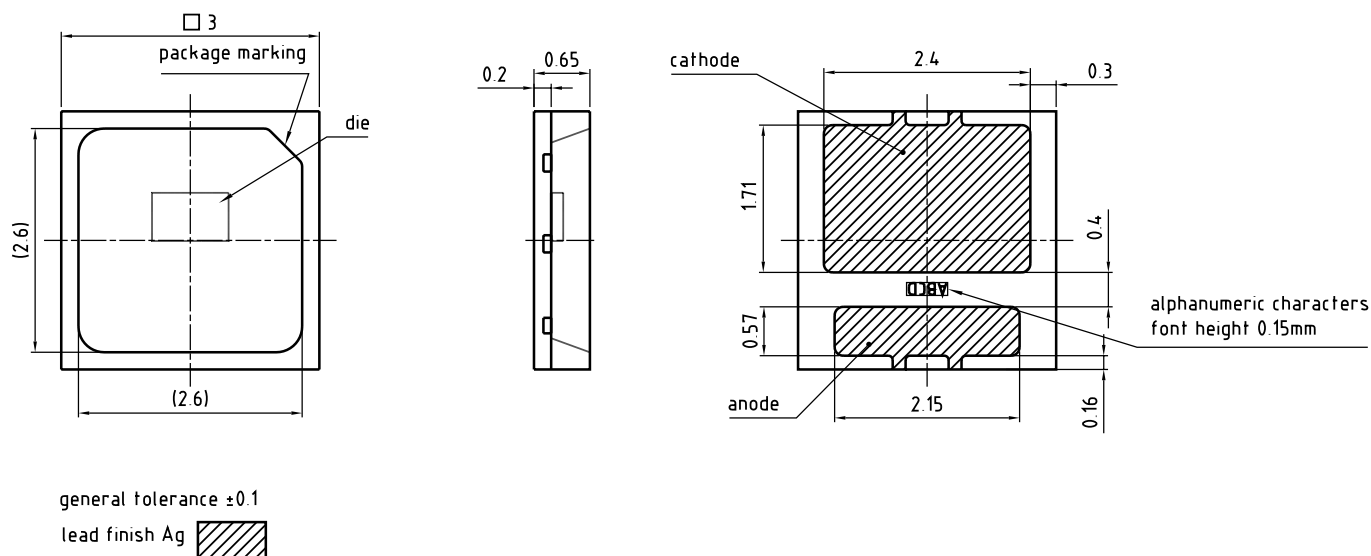

C63062-A4415-A1.-03

Further Information:

Approximate Weight: 16.0 mg

Corrosion test: Class: 3B
Test condition: 40°C / 90 % RH / 15 ppm H₂S / 14 days (stricter than IEC 60068-2-43)

Recommended Solder Pad ⁸⁾

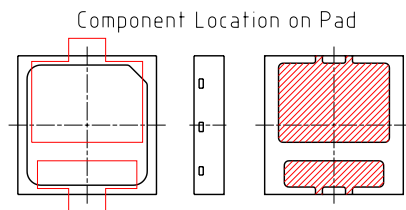
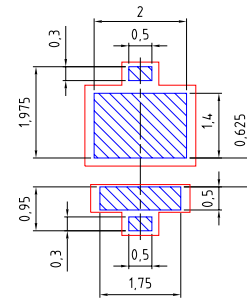
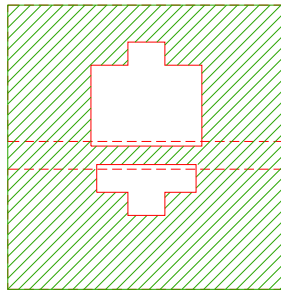
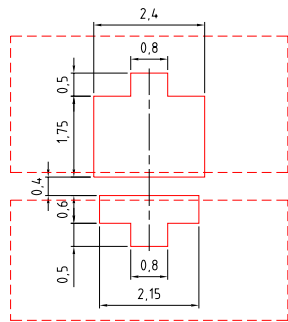

E062.3010.283-01

For superior solder joint connectivity results we recommend soldering under standard nitrogen atmosphere.

Reflow Soldering Profile

Product complies to MSL Level 2 acc. to JEDEC J-STD-020E

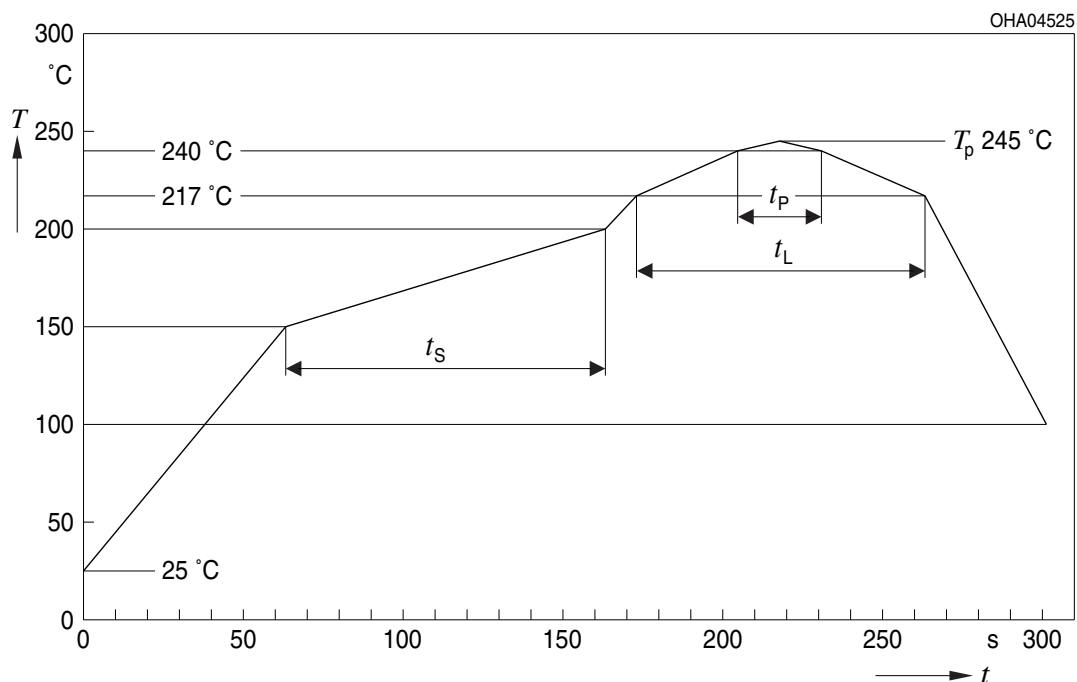

Profile Feature	Symbol	Pb-Free (SnAgCu) Assembly			Unit
		Minimum	Recommendation	Maximum	
Ramp-up rate to preheat ^{*)} 25 °C to 150 °C			2	3	K/s
Time t_s T_{Smin} to T_{Smax}	t_s	60	100	120	s
Ramp-up rate to peak ^{*)} T_{Smax} to T_p			2	3	K/s
Liquidus temperature	T_L		217		°C
Time above liquidus temperature	t_L		80	100	s
Peak temperature	T_p		245	260	°C
Time within 5 °C of the specified peak temperature $T_p - 5$ K	t_p	10	20	30	s
Ramp-down rate* T_p to 100 °C			3	6	K/s
Time 25 °C to T_p				480	s

All temperatures refer to the center of the package, measured on the top of the component
* slope calculation DT/Dt : Dt max. 5 s; fulfillment for the whole T-range

Taping ⁸⁾

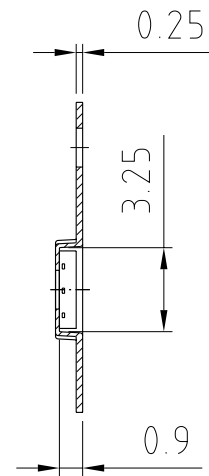
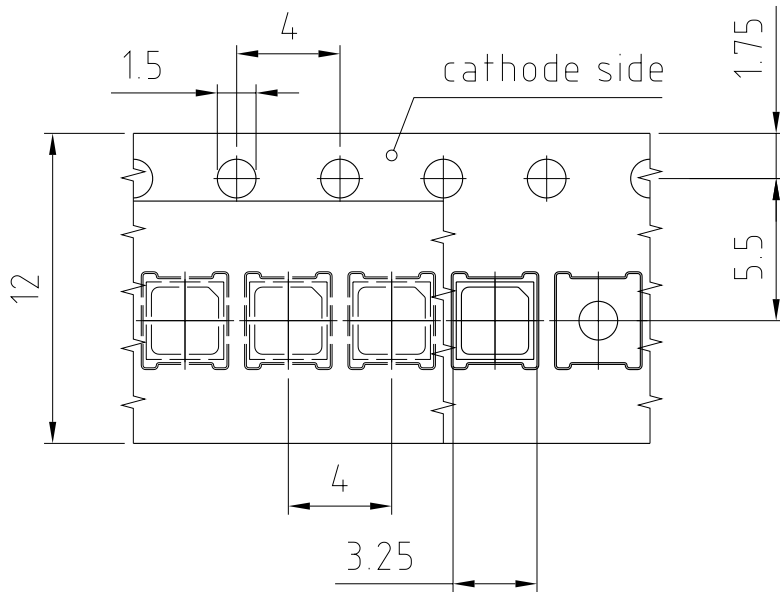

C63062-A4415-B4-02

Taping ⁸⁾

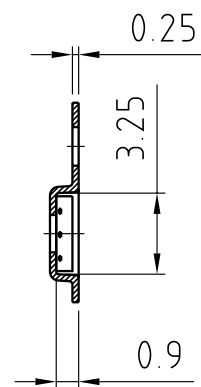
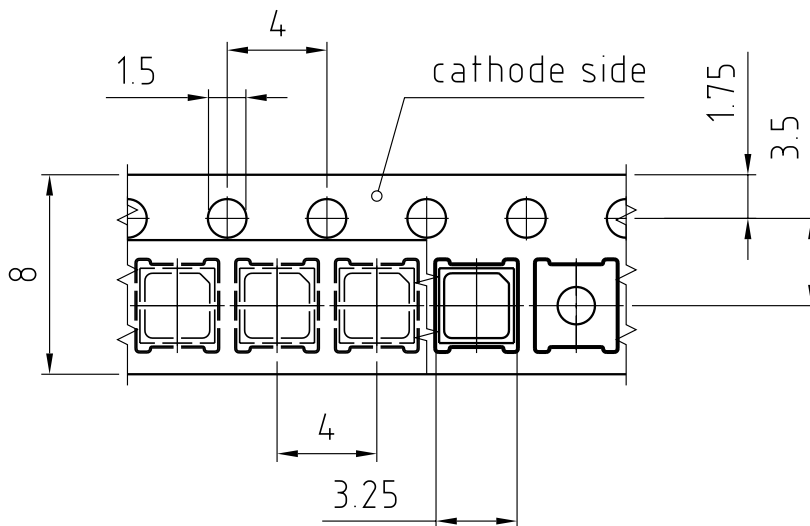

C63062-A4415-B4-03

Tape and Reel ⁹⁾

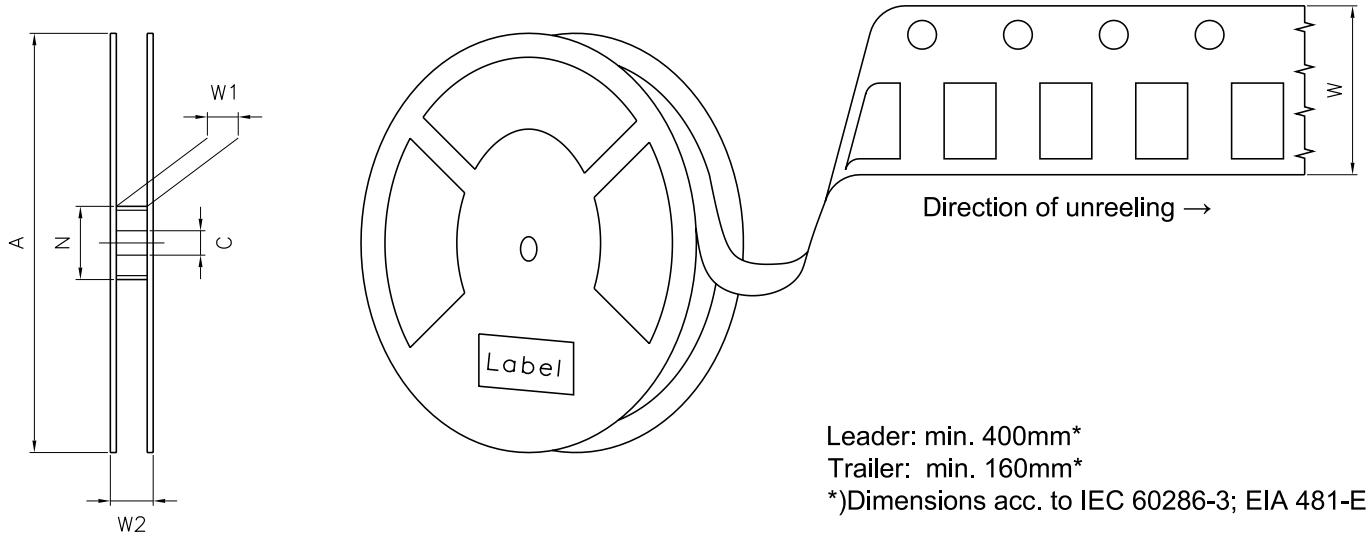

Reel Dimensions

A	W	N _{min}	W ₁	W _{2max}	Pieces per PU
180 mm	8 + 0.3 / - 0.1 mm	60 mm	8.4 + 2 mm	14.4 mm	4500
180 mm	12 + 0.3 / - 0.1 mm	60 mm	12.4 + 2 mm	18.4 mm	4500

Barcode-Product-Label (BPL)

OSRAM LX XXXX BIN1: XX-XX-X-XXX-X

RoHS Compliant

(6P) BATCH NO: 1234567890

(1T) LOT NO: 1234567890 (9D) D/C: 1234

(X) PROD NO: 123456789 (Q) QTY: 9999 (G) GROUP: XX-XX-X-X

ML Temp ST
X XXX °C X

Pack: RXX
DEMY XXX
X_X123_1234.1234 X

OHA04563

Dry Packing Process and Materials ⁸⁾



Moisture-sensitive product is packed in a dry bag containing desiccant and a humidity card according JEDEC-STD-033.

Notes

The evaluation of eye safety occurs according to the standard IEC 62471:2006 (photo biological safety of lamps and lamp systems). Within the risk grouping system of this IEC standard, the device specified in this data sheet fall into the class **low risk (exposure time 100 s)**. Under real circumstances (for exposure time, conditions of the eye pupils, observation distance), it is assumed that no endangerment to the eye exists from these devices. As a matter of principle, however, it should be mentioned that intense light sources have a high secondary exposure potential due to their blinding effect. When looking at bright light sources (e.g. headlights), temporary reduction in visual acuity and afterimages can occur, leading to irritation, annoyance, visual impairment, and even accidents, depending on the situation.

Subcomponents of this device contain, in addition to other substances, metal filled materials including silver. Metal filled materials can be affected by environments that contain traces of aggressive substances. Therefore, we recommend that customers minimize device exposure to aggressive substances during storage, production, and use. Devices that showed visible discoloration when tested using the described tests above did show no performance deviations within failure limits during the stated test duration. Respective failure limits are described in the IEC60810.

For further application related information please visit www.osram-os.com/appnotes

Disclaimer

Attention please!

The information describes the type of component and shall not be considered as assured characteristics. Terms of delivery and rights to change design reserved. Due to technical requirements components may contain dangerous substances.

For information on the types in question please contact our Sales Organization.

If printed or downloaded, please find the latest version on our website.

Packing

Please use the recycling operators known to you. We can also help you – get in touch with your nearest sales office. By agreement we will take packing material back, if it is sorted. You must bear the costs of transport. For packing material that is returned to us unsorted or which we are not obliged to accept, we shall have to invoice you for any costs incurred.

Product and functional safety devices/applications or medical devices/applications

Our components are not developed, constructed or tested for the application as safety relevant component or for the application in medical devices.

Our products are not qualified at module and system level for such application.

In case buyer – or customer supplied by buyer – considers using our components in product safety devices/ applications or medical devices/applications, buyer and/or customer has to inform our local sales partner immediately and we and buyer and /or customer will analyze and coordinate the customer-specific request between us and buyer and/or customer.

Glossary

- 1) **Brightness:** Brightness values are measured during a current pulse of typically 25 ms, with an internal reproducibility of $\pm 8\%$ and an expanded uncertainty of $\pm 11\%$ (acc. to GUM with a coverage factor of $k = 3$).
- 2) **Reverse Operation:** This product is intended to be operated applying a forward current within the specified range. Applying any continuous reverse bias or forward bias below the voltage range of light emission shall be avoided because it may cause migration which can change the electro-optical characteristics or damage the LED.
- 3) **Chromaticity coordinate groups:** Chromaticity coordinates are measured during a current pulse of typically 25 ms, with an internal reproducibility of ± 0.005 and an expanded uncertainty of ± 0.01 (acc. to GUM with a coverage factor of $k = 3$).
- 4) **Forward Voltage:** The forward voltage is measured during a current pulse of typically 8 ms, with an internal reproducibility of ± 0.05 V and an expanded uncertainty of ± 0.1 V (acc. to GUM with a coverage factor of $k = 3$).
- 5) **Thermal Resistance:** $R_{th\ max}$ is based on statistic values (6σ).
- 6) **Typical Values:** Due to the special conditions of the manufacturing processes of semiconductor devices, the typical data or calculated correlations of technical parameters can only reflect statistical figures. These do not necessarily correspond to the actual parameters of each single product, which could differ from the typical data and calculated correlations or the typical characteristic line. If requested, e.g. because of technical improvements, these typ. data will be changed without any further notice.
- 7) **Characteristic curve:** In the range where the line of the graph is broken, you must expect higher differences between single devices within one packing unit.
- 8) **Tolerance of Measure:** Unless otherwise noted in drawing, tolerances are specified with ± 0.1 and dimensions are specified in mm.
- 9) **Tape and Reel:** All dimensions and tolerances are specified acc. IEC 60286-3 and specified in mm.

Revision History

Version	Date	Change
1.0	2020-11-18	Initial Version
1.1	2021-11-02	Reel Dimensions
1.2	2022-07-21	New Layout Applications
1.3	2022-12-06	Features
1.4	2023-03-09	Characteristics



EU RoHS and China RoHS compliant product

此产品符合欧盟 RoHS 指令的要求；
按照中国的相关法规和标准，
不含有毒有害物质或元素。

Published by ams-OSRAM AG

Tobelbader Strasse 30, 8141 Premstaetten, Austria

Phone +43 3136 500-0

ams-osram.com

© All rights reserved

am 

OSRAM