

3A, 45V - 60V Low V_F Trench Schottky Surface Mount Rectifier

FEATURES

- Patented Trench Schottky technology
- Excellent high temperature stability
- Low forward voltage
- Lower power loss/ high efficiency
- High forward surge capability
- Moisture sensitivity level: level 1, per J-STD-020
- RoHS Compliant
- Halogen-free according to IEC 61249-2-21

APPLICATIONS

- Switching mode power supply (SMPS)
- Adapters
- DC to DC converters

MECHANICAL DATA

- Case: SOD-123W
- Molding compound meets UL 94V-0 flammability rating
- Terminal: Matte tin plated leads, solderable per J-STD-002
- Meet JESD 201 class 2 whisker test
- Polarity: Indicated by cathode band
- Weight: 0.016g (approximately)

KEY PARAMETERS		
PARAMETER	VALUE	UNIT
I_F	3	A
V_{RRM}	45 - 60	V
I_{FSM}	50	A
T_{JMAX}	150	°C
Package	SOD-123W	
Configuration	Single die	

SOD-123W

ABSOLUTE MAXIMUM RATINGS ($T_A = 25^\circ\text{C}$ unless otherwise noted)				
PARAMETER	SYMBOL	TSSW3U45	TSSW3U60	UNIT
Marking code on the device		W3U45	W3U60	
Repetitive peak reverse voltage	V_{RRM}	45	60	V
Reverse voltage, total rms value	$V_{R(RMS)}$	31	42	V
Forward current	I_F	3		A
Peak forward surge current, 8.3ms single half sine-wave superimposed on rated load	I_{FSM}	50		A
Junction temperature	T_J	- 55 to +150		°C
Storage temperature	T_{STG}	- 55 to +150		°C

THERMAL PERFORMANCE

PARAMETER	SYMBOL	TYP	UNIT
Junction-to-lead thermal resistance	$R_{\theta JL}$	20	°C/W
Junction-to-ambient thermal resistance	$R_{\theta JA}$	75	°C/W

ELECTRICAL SPECIFICATIONS ($T_A = 25^\circ\text{C}$ unless otherwise noted)

PARAMETER	CONDITIONS	SYMBOL	TYP	MAX	UNIT	
Forward voltage ⁽¹⁾	$I_F = 1\text{A}, T_J = 25^\circ\text{C}$	V_F	0.33	-	V	
			TSSW3U60	0.39	-	V
	$I_F = 3\text{A}, T_J = 25^\circ\text{C}$		TSSW3U45	0.40	0.47	V
			TSSW3U60	0.49	0.58	V
	$I_F = 1\text{A}, T_J = 125^\circ\text{C}$		TSSW3U45	0.24	-	V
			TSSW3U60	0.28	-	V
	$I_F = 3\text{A}, T_J = 125^\circ\text{C}$		TSSW3U45	0.34	0.44	V
			TSSW3U60	0.43	0.52	V
Reverse current @ rated V_R ⁽²⁾	$T_J = 25^\circ\text{C}$	I_R	-	1	mA	
	$T_J = 125^\circ\text{C}$		-	50	mA	

Notes:

1. Pulse test with $PW = 0.3\text{ms}$
2. Pulse test with $PW = 30\text{ms}$

ORDERING INFORMATION

ORDERING CODE ⁽¹⁾	PACKAGE	PACKING
TSSW3Ux	SOD-123W	10,000 / Tape & Reel

Notes:

1. "x" defines voltage from 45V(TSSW3U45) to 60V(TSSW3U60)

CHARACTERISTICS CURVES

($T_A = 25^\circ\text{C}$ unless otherwise noted)

Fig.1 Forward Current Derating Curve

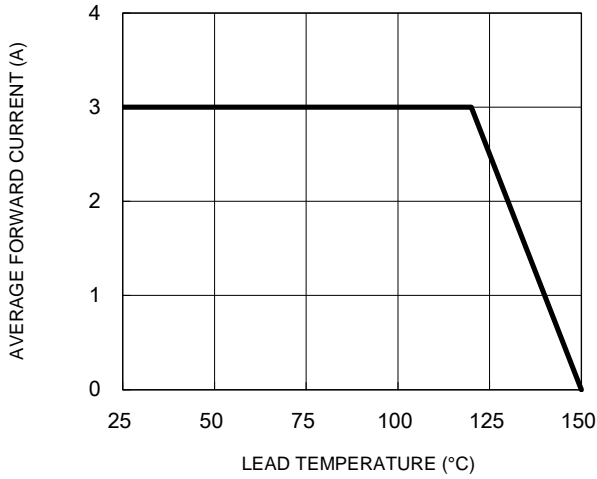

Fig.2 Typical Junction Capacitance

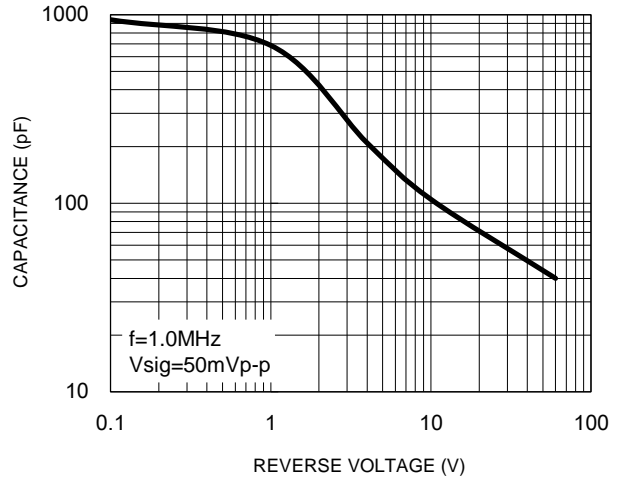

Fig.3 Typical Reverse Characteristics

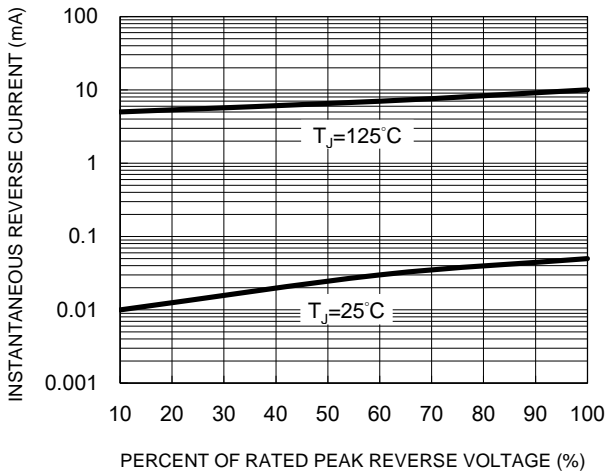

Fig.4 Typical Forward Characteristics

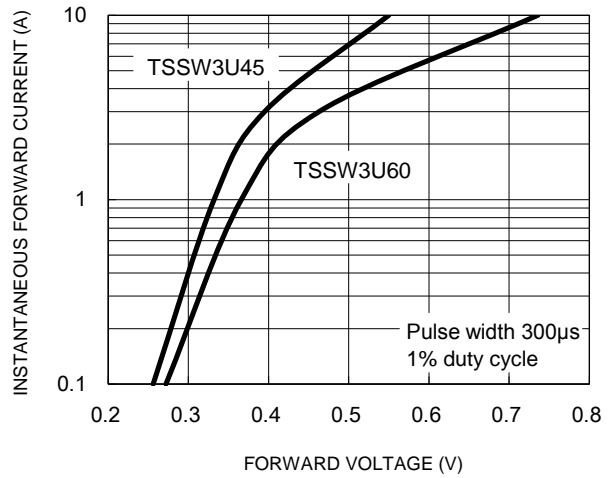
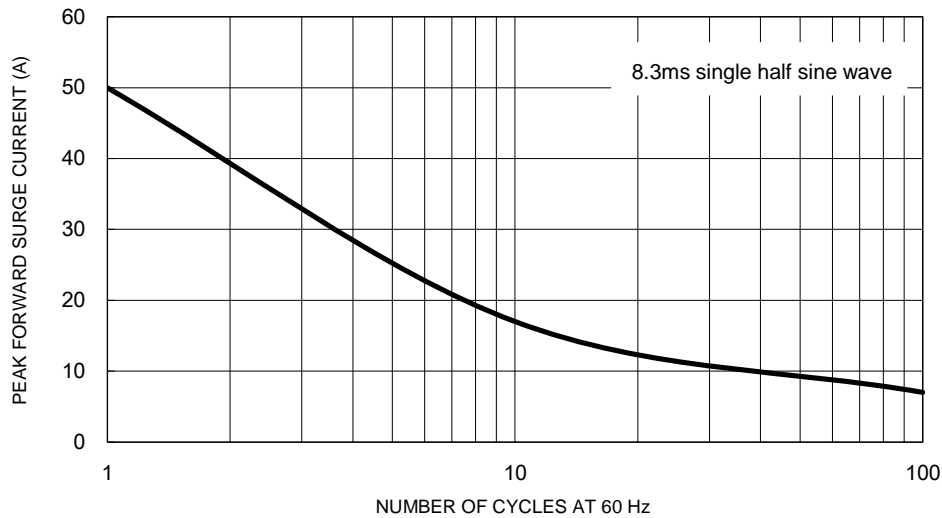
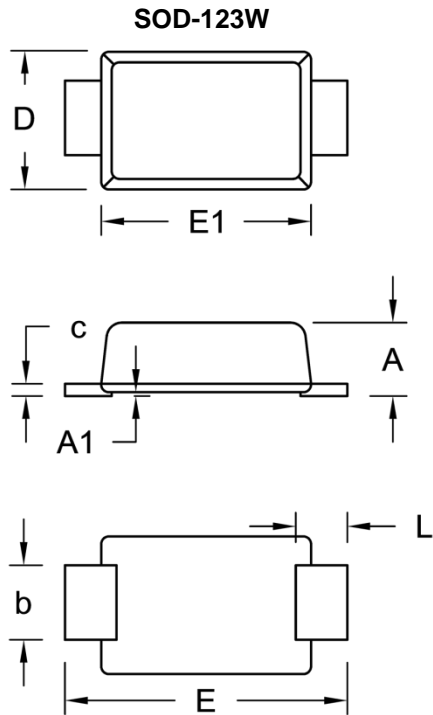

Fig.5 Maximum Non-Repetitive Forward Surge Current



PACKAGE OUTLINE DIMENSIONS



DIM.	Unit (mm)		Unit (inch)	
	Min.	Max.	Min.	Max.
A	0.90	1.02	0.035	0.040
A1	0.00	0.10	0.000	0.004
b	0.90	1.05	0.035	0.041
c	0.10	0.22	0.004	0.009
D	1.70	1.90	0.067	0.075
E	3.60	3.80	0.142	0.150
E1	2.60	2.90	0.102	0.114
L	0.50	0.85	0.020	0.033

SUGGESTED PAD LAYOUT

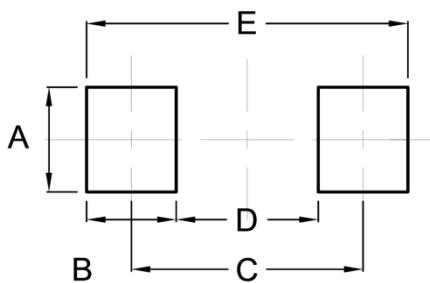

Symbol	Unit (mm)	Unit (inch)
A	1.40	0.055
B	1.20	0.047
C	3.10	0.122
D	1.90	0.075
E	4.30	0.169

MARKING DIAGRAM



P/N = Marking Code
 YW = Date Code
 F = Factory Code

Notice

Specifications of the products displayed herein are subject to change without notice. TSC or anyone on its behalf assumes no responsibility or liability for any errors or inaccuracies.

Purchasers are solely responsible for the choice, selection, and use of TSC products and TSC assumes no liability for application assistance or the design of Purchasers' products.

Information contained herein is intended to provide a product description only. No license, express or implied, to any intellectual property rights is granted by this document. Except as provided in TSC's terms and conditions of sale for such products, TSC assumes no liability whatsoever, and disclaims any express or implied warranty, relating to sale and/or use of TSC products including liability or warranties relating to fitness for a particular purpose, merchantability, or infringement of any patent, copyright, or other intellectual property right.

The products shown herein are not designed for use in medical, life-saving, or life-sustaining applications. Customers using or selling these products for use in such applications do so at their own risk and agree to fully indemnify TSC for any damages resulting from such improper use or sale.