

## SR320-HF Thru. SR3200-HF

Forward current: 3.0A

Reverse voltage: 20 to 200V

RoHS Device

Halogen Free

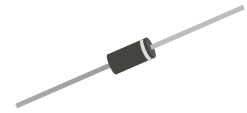

### Features

- Axial lead type devices for through hole design.
- Low power loss, high efficiency.
- High current capability, Low forward voltage drop.
- High surge capability.
- Ultra high-speed switching.
- Silicon epitaxial planar chip, metal silicon junction.
- Lead-free part meets environmental standards of MIL-STD-19500/228

### Mechanical Data

- Case: Molded plastic, DO-201AD/DO-27
- Epoxy: UL94V-0 rate flame retardant.
- Lead: Axial lead, solderable per MIL-STD-202, Method 208 guaranteed.
- Polarity: color band denoted cathode end.
- Weight: 1.10 grams(approx.).

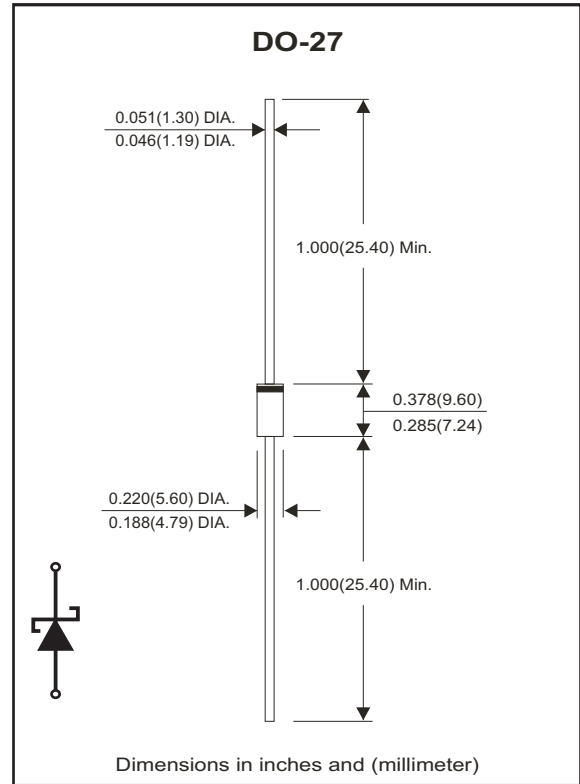

### Maximum Ratings and Electrical Characteristics

Ratings at Ta=25°C unless otherwise noted.  
Single phase, half wave, 60Hz, resistive or inductive loaded.  
For capacitive load, derate current by 20% .

Parameter	Symbol	SR320 -HF	SR340 -HF	SR360 -HF	SR3100 -HF	SR3150 -HF	SR3200 -HF	Unit
Maximum repetitive peak reverse voltage	V <sub>RRM</sub>	20	40	60	100	150	200	V
Maximum RMS voltage	V <sub>RMS</sub>	14	28	42	70	105	140	V
Maximum DC blocking voltage	V <sub>DC</sub>	20	40	60	100	150	200	V
Maximum forward voltage @3A, TA=25°C	V <sub>F</sub>	0.45	0.50	0.70	0.81	0.87	0.90	V
Operating junction temperature range	T <sub>J</sub>	-50 ~ +150				-50 ~ +175		°C

Parameter	Conditions	Symbol	MIN.	TYP.	MAX.	Unit
Forward rectified current	see Fig.1	I <sub>o</sub>			3.0	A
Forward surge current	8.3ms single half sine-wave superimposed on rate load (JEDEC method)	I <sub>FSM</sub>			70	A
Reverse current	V <sub>R</sub> =V <sub>RRM</sub> TA=25°C	I <sub>R</sub>			0.5	mA
	V <sub>R</sub> =V <sub>RRM</sub> TA=100°C	I <sub>R</sub>			20	mA
Thermal resistance	Junction to ambient	R <sub>θJA</sub>		55		°C/W
Diode junction capacitance	f=1MHz and applied 4V DC reverse Voltage	C <sub>J</sub>		250		pF
Storage temperature range		T <sub>STG</sub>	-55		+175	°C

Company reserves the right to improve product design , functions and reliability without notice.

REV:B

## RATING AND CHARACTERISTIC CURVES (SR320-HF Thru. SR3200-HF)

Fig.1 - Typical Forward Current Derating Curve

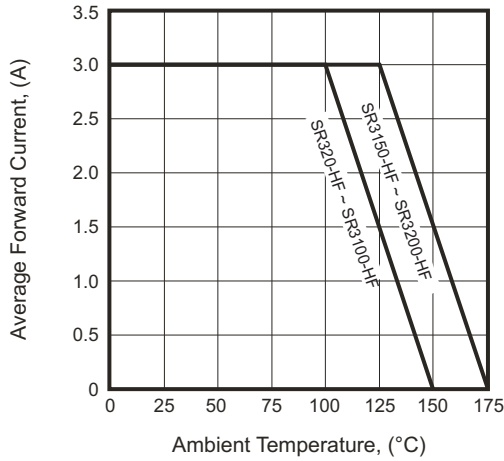

Fig.2 - Typical Forward Characteristics

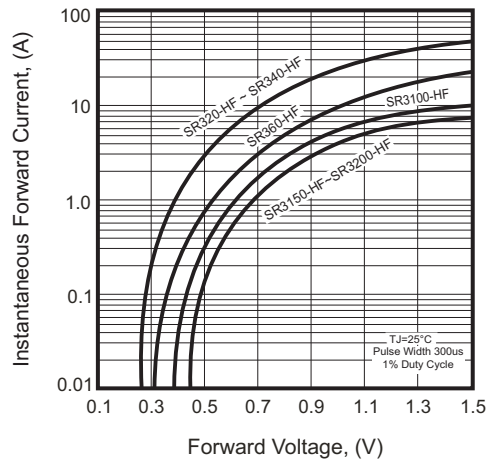

Fig.3 - Maximum Non-repetitive Forward Surge Current

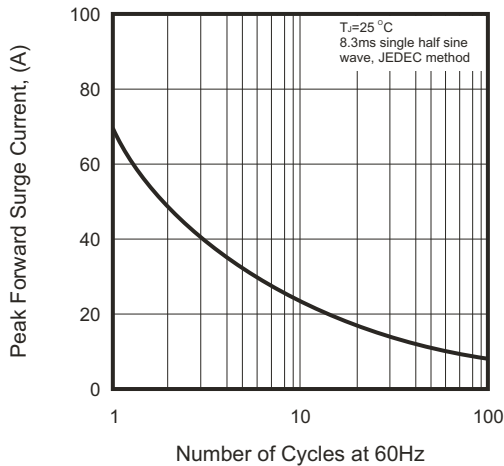

Fig.4 - Typical Junction Capacitance

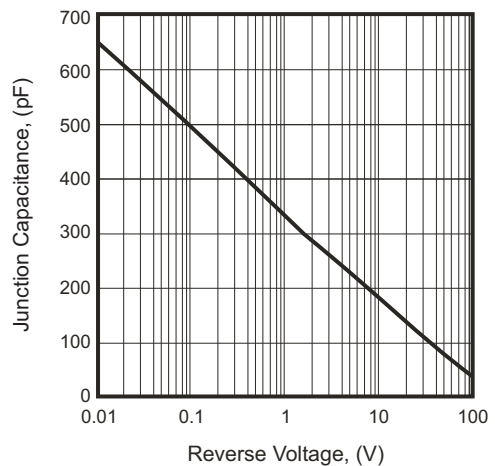
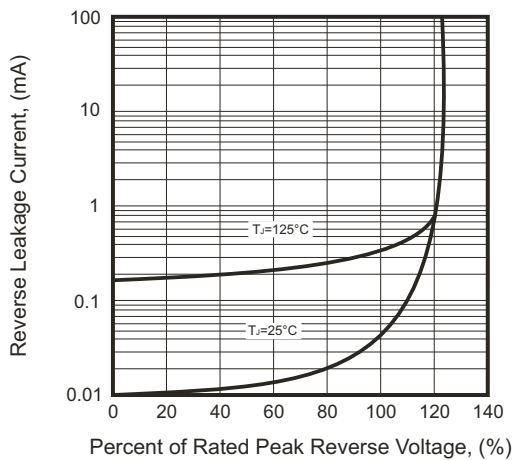
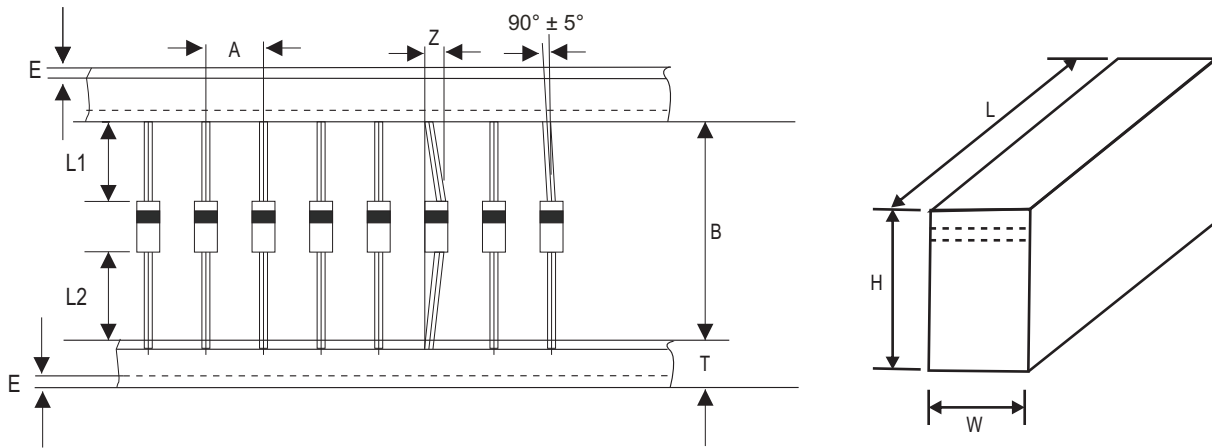

Fig.5 - Typical Reverse Characteristics



## Taping Specification For Axial Lead Diodes



DO-27	SYMBOL	A	B	Z	T	E
	(mm)	10.00 ± 0.50	52.40 (max)	1.60 (max)	6.00 ± 0.40	3.00 (max)
	(inch)	0.394 ± 0.020	2.063 (max)	0.062 (max)	0.236 ± 0.016	0.118 (max)

DO-27	SYMBOL	L1-L2	L	W	H
	(mm)	1.00(max)	260 ± 5.00	75 ± 5.00	145 ± 5.00
	(inch)	0.039(max)	10.236 ± 0.197	2.953 ± 0.197	5.709 ± 0.197

## Marking Code

Part Number	Marking Code
SR320-HF	SR32
SR340-HF	SR34
SR360-HF	SR36
SR3100-HF	SR310
SR3150-HF	SR315
SR3200-HF	SR320

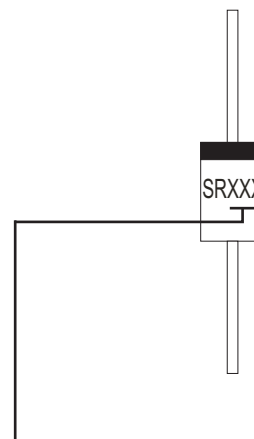

XX / XXX = Product type marking code

## Standard Packaging

Case Type	AMMO PACK	
	BOX ( pcs )	CARTON ( pcs )
DO-27	1,200	12,000

Company reserves the right to improve product design , functions and reliability without notice.