

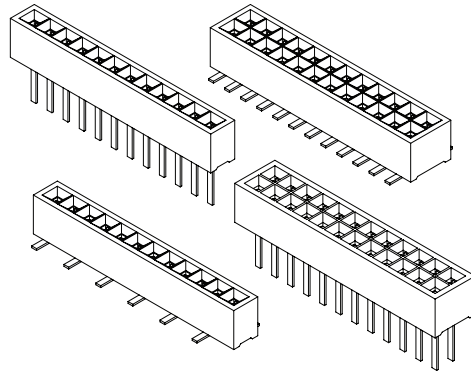

1.00 mm [.039"] Contact Centers, Female Headers, Straight/SMT- SFM Series Mates with SMH series

SPECIFICATIONS

- 1 Amp current rating
- UL Flammability Rating: 94V-0
- Insulator Material: Black LCP
- Contact Material: Phosphor Bronze
- Contact Resistance: 20 milli Ohms Max.
- Operating Temperature: -40°C to +125°C
- Processing Temperature: 260°C Max. for 10 seconds



TERMINATION TYPE

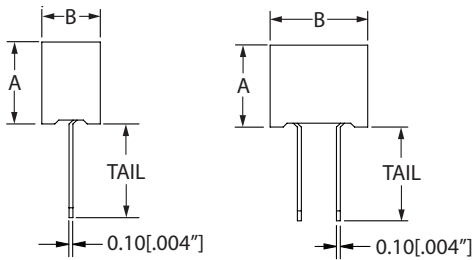

Single Row, Straight, (ST)

Dual Row, Straight, (ST)

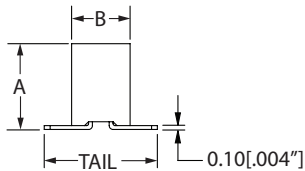

Single Row, SMT, Pin 1 Left (SC) or SMT, Pin 1 Right (SD)

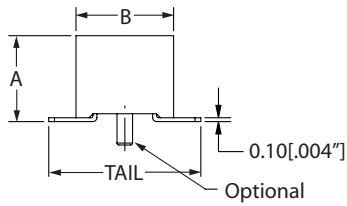

SFM210-, Dual Row, SMT Without Guide Posts (SM) or SMT With Guide Posts (SP)

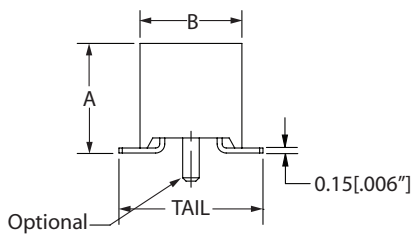

SFM315-, Dual Row, SMT Without Guide Posts (SM) or SMT With Guide Posts (SP)

STRAIGHT

EXAMPLE P/N	A	B	TAIL
SINGLE ROW			
SFM210-LPPE-S10-ST-BK	2.10 [.083"]	1.50 [.059"]	2.40 [.094"]
DUAL ROW			
SFM210-LPPE-D10-ST-BK	2.10 [.083"]	2.50 [.098"]	2.40 [.094"]

SURFACE MOUNT

EXAMPLE P/N	A	B	TAIL
SINGLE ROW			
SFM210-LPPE-S10-SC-BK	2.20 [.087"]	1.50 [.059"]	2.90 [.114"]
SFM210-LPPE-S10-SD-BK	2.20 [.087"]	1.50 [.059"]	2.90 [.114"]

SURFACE MOUNT

EXAMPLE P/N	A	B	TAIL
DUAL ROW			
SFM210-LPPE-D10-SM-BK	2.20 [.087"]	2.50 [.098"]	3.90 [.154"]
SFM210-LPPE-D10-SP-BK	2.20 [.087"]	2.50 [.098"]	3.90 [.154"]

SURFACE MOUNT

EXAMPLE P/N	A	B	TAIL
DUAL ROW			
SFM315-LPPE-D10-SM-BK	3.30 [.130"]	3.07 [.121"]	4.34 [.171"]
SFM315-LPPE-D10-SP-BK	3.30 [.130"]	3.07 [.121"]	4.34 [.171"]



1.00 mm [.039"] Contact Centers, Female Headers, Straight/SMT- SFM Series

Mates with SMH series

PART NUMBER OPTIONS

SFM210 - L P P E - S 10 - ST - BK

SERIES (See Opposite Page)

SFM210 = 2.10 mm [.083"] Profile
SFM315 = 3.15 mm [.124"] Profile

INSULATOR MATERIAL

L = LCP

CONTACT MATERIAL

P = Phosphor Bronze

CONTACT FINISH - RoHS Compliant

P = Gold Flash Overall

S = .00010" Gold on Contact Surface, Gold Flash on Termination, (SFM 210 series)

G = .00010" Gold on Contact Surface, Gold Flash on Termination, (SFM315 series)

CONTACT CENTERS

E = 1.00 mm [.039"]

COLOR

BK = Black

TERMINATION TYPE (See Opposite Page)

ST = Straight (Single & Dual Row)

SC = Surface Mount, Standard (Single Row)

SD = Surface Mount, Opposite Bend,

Applicable on Even Pin Counts (Single Row)

SM = Surface Mount without Guide Posts (Dual Row)

SP = Surface Mount with Guide Posts (Dual Row)

NUMBER OF CONTACT POSITIONS (Pins per Row)

02 thru 50

NUMBER OF ROWS

S = Single Row

D = Dual Row

DIMENSIONS

STRAIGHT

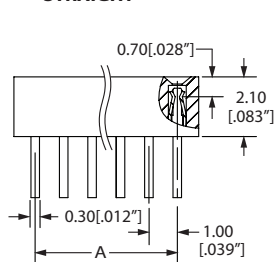

Surface Mount Top/Bottom Entry, Single Row

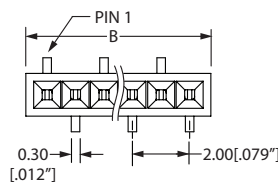

(SC) STANDARD

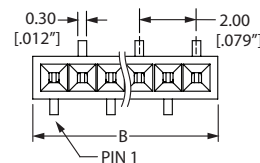

(SD) OPPOSITE BEND,
APPLICABLE ON EVEN PIN COUNTS

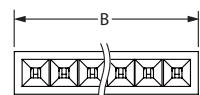
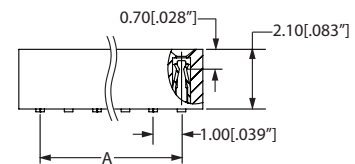

SINGLE ROW

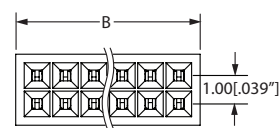

DUAL ROW

Surface Mount Top/Bottom Entry, Dual Row

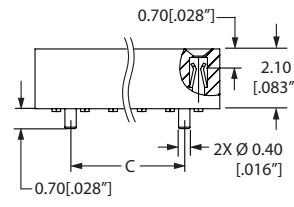
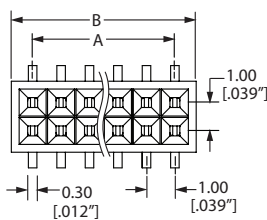

SFM210-

OPTIONAL GUIDE POSTS REQUIRE (SP) TERMINATION TYPE

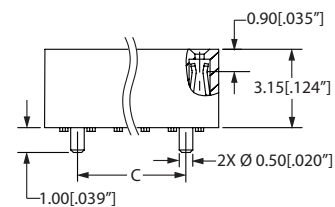

SFM315-

NUMBER OF CONTACTS SINGLE/ DUAL	A		B (SFM210)		B (SFM315)		C		NUMBER OF CONTACTS SINGLE/ DUAL	A		B (SFM210)		B (SFM315)		C	
	mm	in	mm	in	mm	in	mm	in		mm	in	mm	in	mm	in	mm	in
02/04*	1.00	0.039	2.50	0.098	2.40	0.094	N/A	N/A	27/54	26.00	1.024	27.50	1.083	27.40	1.079	25.00	0.984
03/06	2.00	0.079	3.50	0.138	3.40	0.134	1.00	0.039	28/56	27.00	1.063	28.50	1.122	28.40	1.118	26.00	1.024
04/08	3.00	0.118	4.50	0.177	4.40	0.173	2.00	0.079	29/58	28.00	1.102	29.50	1.161	29.40	1.157	27.00	1.063
05/10	4.00	0.157	5.50	0.217	5.40	0.213	3.00	0.118	30/60	29.00	1.142	30.50	1.201	30.40	1.197	28.00	1.102
06/12	5.00	0.197	6.50	0.256	6.40	0.252	4.00	0.157	31/62	30.00	1.181	31.50	1.240	31.40	1.236	29.00	1.142
07/14	6.00	0.236	7.50	0.295	7.40	0.291	5.00	0.197	32/64	31.00	1.220	32.50	1.280	32.40	1.276	30.00	1.181
08/16	7.00	0.276	8.50	0.335	8.40	0.331	6.00	0.236	33/66	32.00	1.260	33.50	1.319	33.40	1.315	31.00	1.220
09/18	8.00	0.315	9.50	0.374	9.40	0.370	7.00	0.276	34/68	33.00	1.299	34.50	1.358	34.40	1.354	32.00	1.260
10/20	9.00	0.354	10.50	0.413	10.40	0.409	8.00	0.315	35/70	34.00	1.339	35.50	1.398	35.40	1.394	33.00	1.299
11/22	10.00	0.394	11.50	0.453	11.40	0.449	9.00	0.354	36/72	35.00	1.378	36.50	1.437	36.40	1.433	34.00	1.339
12/24	11.00	0.433	12.50	0.492	12.40	0.488	10.00	0.394	37/74	36.00	1.417	37.50	1.476	37.40	1.472	35.00	1.378
13/26	12.00	0.472	13.50	0.531	13.40	0.528	11.00	0.433	38/76	37.00	1.457	38.50	1.516	38.40	1.512	36.00	1.417
14/28	13.00	0.512	14.50	0.571	14.40	0.567	12.00	0.472	39/78	38.00	1.496	39.50	1.555	39.40	1.551	37.00	1.457
15/30	14.00	0.551	15.50	0.610	15.40	0.606	13.00	0.512	40/80	39.00	1.535	40.50	1.594	40.40	1.591	38.00	1.496
16/32	15.00	0.591	16.50	0.650	16.40	0.646	14.00	0.551	41/82	40.00	1.575	41.50	1.634	41.40	1.630	39.00	1.535
17/34	16.00	0.630	17.50	0.689	17.40	0.685	15.00	0.591	42/84	41.00	1.614	42.50	1.673	42.40	1.669	40.00	1.575
18/36	17.00	0.669	18.50	0.728	18.40	0.724	16.00	0.630	43/86	42.00	1.654	43.50	1.713	43.40	1.709	41.00	1.614
19/38	18.00	0.709	19.50	0.768	19.40	0.764	17.00	0.669	44/88	43.00	1.693	44.50	1.752	44.40	1.748	42.00	1.654
20/40	19.00	0.748	20.50	0.807	20.40	0.803	18.00	0.709	45/90	44.00	1.732	45.50	1.791	45.40	1.787	43.00	1.693
21/42	20.00	0.787	21.50	0.846	21.40	0.843	19.00	0.748	46/92	45.00	1.772	46.50	1.831	46.40	1.827	44.00	1.732
22/44	21.00	0.827	22.50	0.886	22.40	0.882	20.00	0.787	47/94	46.00	1.811	47.50	1.870	47.40	1.866	45.00	1.772
23/46	22.00	0.866	23.50	0.925	23.40	0.921	21.00	0.827	48/96	47.00	1.850	48.50	1.909	48.40	1.906	46.00	1.811
24/48	23.00	0.906	24.50	0.965	24.40	0.961	22.00	0.866	49/98	48.00	1.890	49.50	1.949	49.40	1.945	47.00	1.850
25/50	24.00	0.945	25.50	1.004	25.40	1.000	23.00	0.906	50/100	49.00	1.929	50.50	1.988	50.40	1.984	48.00	1.890
26/52	25.00	0.984	26.50	1.043	26.40	1.039	24.00	0.945									

* Position 2 not available with guide posts on SFM210 Series (Termination Type SP).