



Figure similar

STARTER, 3RE41227CA354VY0, WITH MODS

| | |
|-------------------------------------------------------------------------|--------------------------------------------------------------|
| product brand name | Siemens |
| product designation | Non-reversing motor starter |
| special product feature | Hand-Off-Auto Selector Switch, CPT Std Capacity 480/240:120V |
| General technical data | |
| weight [lb] | 15 lb |
| Height x Width x Depth [in] | 12 × 10 × 6 in |
| touch protection against electrical shock | NA for enclosed products |
| installation altitude [ft] at height above sea level maximum | 6 560 ft |
| ambient temperature [°F] during storage | -22 ... +149 °F |
| ambient temperature [°F] during operation | -4 ... +104 °F |
| ambient temperature during storage | -30 ... +65 °C |
| ambient temperature during operation | -20 ... +40 °C |
| country of origin | Germany |
| Power and control electronics | |
| number of poles for main current circuit | 3 |
| type of voltage of the control supply voltage | AC |
| control supply voltage | |
| • at AC at 50 Hz rated value | 110 V |
| • at AC at 60 Hz rated value | 120 V |
| disconnecter functionality | No |
| yielded mechanical performance [hp] for 3-phase AC motor | |
| • at 200/208 V rated value | 10 hp |
| • at 220/230 V rated value | 10 hp |
| • at 460/480 V rated value | 20 hp |
| • at 575/600 V rated value | 25 hp |
| Contactors | |
| number of NO contacts for main contacts | 3 |
| operating voltage at AC-3 rated value maximum | 600 V |
| mechanical service life (switching cycles) of the main contacts typical | 10 000 000 |
| Auxiliary contact | |
| number of NC contacts for auxiliary contacts | 1 |
| number of NO contacts for auxiliary contacts | 1 |
| number of total auxiliary contacts maximum | 8 |
| contact rating of auxiliary contacts of contactor according to UL | 10A@600V(A600), 2.5A@600V(Q600) |
| Coil | |
| apparent pick-up power of magnet coil at AC | 79 V·A |

| | |
|-------------------------------------------------------------------------------------------------------------------------|------------------------------------|
| apparent holding power of magnet coil at AC | 8.5 V·A |
| operating range factor control supply voltage rated value of magnet coil | 0.8 ... 1.1 |
| ON-delay time | 8 ... 40 ms |
| OFF-delay time | 4 ... 16 ms |
| Overload relay | |
| product function | |
| • overload protection | Yes |
| • phase failure detection | Yes |
| • asymmetry detection | Yes |
| • ground fault detection | Yes |
| • test function | Yes |
| • external reset | Yes |
| reset function | Manual, automatic and remote |
| trip class | CLASS 5 / 10 / 20 / 30 |
| adjustment range of thermal overload trip unit | 10 ... 40 |
| number of NC contacts of auxiliary contacts of overload relay | 1 |
| number of NO contacts of auxiliary contacts of overload relay | 1 |
| operational current of auxiliary contacts of overload relay | |
| • at AC at 600 V | 5 A |
| • at DC at 250 V | 1 A |
| contact rating of auxiliary contacts of overload relay according to UL | 5A@600VAC (B600), 1A@250VDC (R300) |
| insulation voltage (Ui) | |
| • with single-phase operation at AC rated value | 600 V |
| • with multi-phase operation at AC rated value | 300 V |
| Enclosure | |
| degree of protection NEMA rating of the enclosure | NEMA 3/3R/4/12 enclosure |
| design of the housing | Dust- & watertight for outdoor use |
| Mounting/wiring | |
| mounting position | Vertical |
| fastening method | Surface mounting and installation |
| type of electrical connection for supply voltage line-side | Screw-type terminals |
| tightening torque [lbf·in] for supply | 18 ... 21 lbf·in |
| type of connectable conductor cross-sections at line-side at AWG cables single or multi-stranded | 2x (16 ... 12), 2x (14 ... 8) |
| temperature of the conductor for supply maximum permissible | 60 °C |
| material of the conductor for supply | CU |
| type of electrical connection for load-side outgoing feeder | Screw-type terminals |
| tightening torque [lbf·in] for load-side outgoing feeder | 18 ... 21 lbf·in |
| type of connectable conductor cross-sections at AWG cables for load-side outgoing feeder single or multi-stranded | 2x (16 ... 12), 2x (14 ... 8) |
| temperature of the conductor for load-side outgoing feeder maximum permissible | 60 °C |
| material of the conductor for load-side outgoing feeder | CU |
| type of electrical connection of magnet coil | Screw-type terminals |
| tightening torque [lbf·in] at magnet coil | 7 ... 10 lbf·in |
| type of connectable conductor cross-sections of magnet coil at AWG cables single or multi-stranded | 2x (20 ... 16), 2x (18 ... 14) |
| temperature of the conductor at magnet coil maximum permissible | 75 °C |
| material of the conductor at magnet coil | CU |
| type of electrical connection for auxiliary contacts | Screw-type terminals |
| tightening torque [lbf·in] at contactor for auxiliary contacts | 7 ... 10 lbf·in |
| type of connectable conductor cross-sections at contactor at AWG cables for auxiliary contacts single or multi-stranded | 2x (20 ... 16), 2x (18 ... 14) |
| temperature of the conductor at contactor for auxiliary contacts maximum permissible | 75 °C |

| | |
|------------------------------------------------------------------------------------------------------------------------------------------------------------|----------------------------------|
| material of the conductor at contactor for auxiliary contacts | CU |
| tightening torque [lbf-in] at overload relay for auxiliary contacts | 7 ... 10 lbf-in |
| type of connectable conductor cross-sections at overload relay at AWG cables for auxiliary contacts single or multi-stranded | 1x (20 ... 14), 2x (20 ... 14) |
| temperature of the conductor at overload relay for auxiliary contacts maximum permissible | 75 °C |
| material of the conductor at overload relay for auxiliary contacts | CU |
| Short-circuit current rating | |
| design of the fuse link for short-circuit protection of the main circuit required | Class J |
| design of the short-circuit trip | Thermal magnetic circuit breaker |
| breaking capacity maximum short-circuit current (Icu) <ul style="list-style-type: none"> • at 240 V • at 480 V • at 600 V | 5 kA 5 kA 5 kA |
| certificate of suitability | UL 60947-4-1 |

Further information

Industrial Controls - Product Overview (Catalogs, Brochures,...)

www.usa.siemens.com/iccatalog

Industry Mall (Online ordering system)

<https://mall.industry.siemens.com/mall/en/us/Catalog/product?mlfb=3RE4122-7CA35-4VH3>

Search Datasheet in Service&Support (Manuals)

<https://support.industry.siemens.com/cs/US/en/ps/3RE4122-7CA35-4VH3/man>

Image database (product images, 2D dimension drawings, 3D models, device circuit diagrams, EPLAN macros, ...)

http://www.automation.siemens.com/bilddb/cax_de.aspx?mlfb=3RE4122-7CA35-4VH3&lang=en

Certificates/approvals

<https://support.industry.siemens.com/cs/US/en/ps/3RE4122-7CA35-4VH3/certificate>

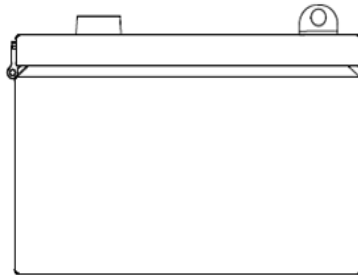
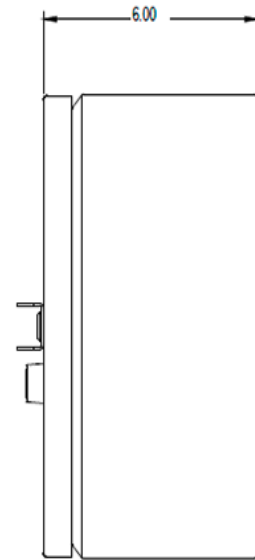
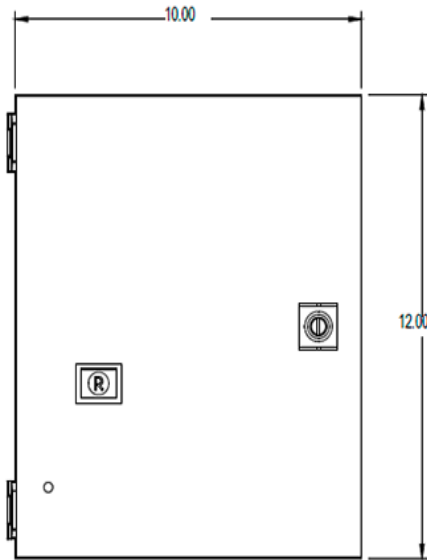
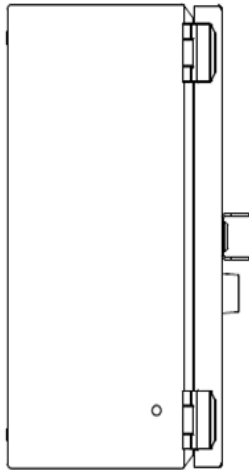
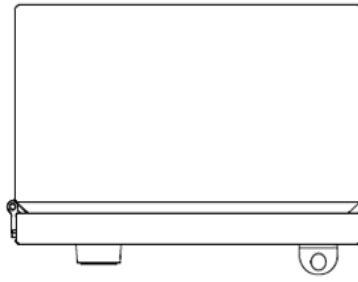

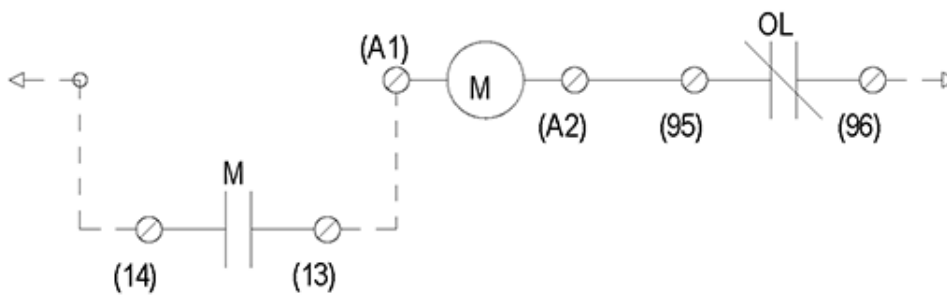
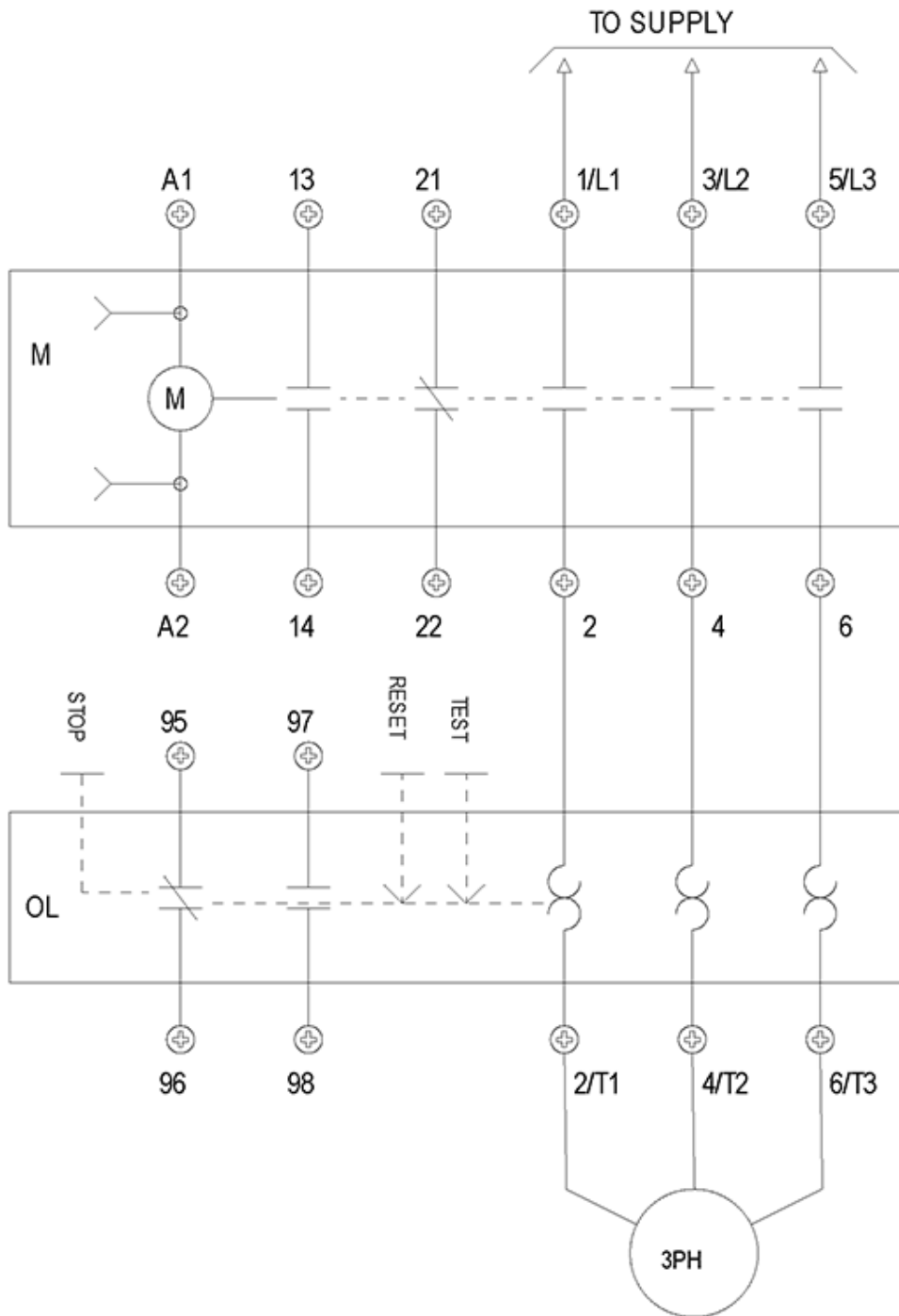

last modified:

4/15/2021