



ANSI/AAMI ES60601-1 BS EN/EN60601-1 IEC60601-1



■ Features

- 5"×3" compact size
- 320W convection, 500W force air
- 550W peak power (3sec.)
- Medical safety approved (2 x MOPP) according to ANSI/AAMI ES60601-1 and IEC/BS EN/EN60601-1
- EMI for both Class I & Class II configuration
- -30~+70°C wide range operating temperature
- No load power consumption < 0.5W by PS_ON control
- High efficiency up to 94%
- Protections: Short circuit / Overload / Over voltage / Over temperature
- 5Vdc standby output, 12Vdc fan supply, Power Good, Power Fail and remote sense
- Operating altitude up to 4000 meters (Note.5)
- LED indicator for power on
- 3 years warranty

■ Applications

- Oral irrigator
- Hemodialysis machine
- Medical computer monitors
- Sleep apnea devices
- Pump machine
- Electric bed

■ GTIN CODE

MW Search: <https://www.meanwell.com/serviceGTIN.aspx>

■ Description

RPS-500 is a 500W highly reliable green PCB type medical power supply with a high power density on the 5" by 3" footprint. It accepts 80~264VAC input and offers various output voltages between 12V and 48V. The working efficiency is up to 94% and the extremely low no load power consumption is down below 0.5W. RPS-500 (blank type only) is able to be used for both Class I (with FG) and Class II (no FG) system design. The extremely low leakage current is less than 220µA. In addition, it conforms to international medical regulations (2*MOPP) and EMC BS EN/EN55011, perfectly fitting all kinds of BF rated "patient contact" medical system equipment. RPS-500 series also offers the enclosed style models (-C / TF / SF)

■ Model Encoding

RPS - 500 - 12 - C

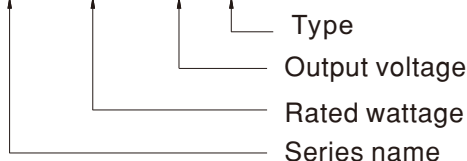

| Type | Description | Note |
|-------|------------------------------------|----------|
| Blank | PCB Type | In stock |
| -C | Enclosed casing Type | In stock |
| -TF | Enclosed Type with fan on the top | In stock |
| -SF | Enclosed Type with fan on the side | In stock |



500W 5"×3" Reliable Green Medical Power Supply **RPS-500** series

SPECIFICATION

| MODEL | | | RPS-500-12□ | RPS-500-15□ | RPS-500-18□ | RPS-500-24□ | RPS-500-27□ | RPS-500-36□ | RPS-500-48□ | |
|---------------------------|---------------------------------|--|---|-------------|-------------|-------------|-------------|-------------|-------------|--------|
| OUTPUT | DC VOLTAGE | | 12V | 15V | 18V | 24V | 27V | 36V | 48V | |
| | RATED CURRENT Note.7 | Blank | 25CFM | 41.6A | 33.3A | 27.8A | 20.8A | 18.5A | 13.9A | 10.4A |
| | | | Convection | 26.7A | 21.3A | 17.8A | 13.4A | 11.9A | 8.9A | 6.7A |
| | | - C | 25CFM | 41.6A | 33.3A | 27.8A | 20.8A | 18.5A | 13.9A | 10.4A |
| | | | Convection | 25.8A | 20.7A | 17.2A | 12.9A | 11.5A | 8.6A | 6.5A |
| | - TF/SF | Built-in fan | 41.6A | 33.3A | 27.8A | 20.8A | 18.5A | 13.9A | 10.4A | |
| | RATED POWER Note.7 | Blank | 25CFM | 499.2W | 499.5W | 500.4W | 499.2W | 499.5W | 500.4W | 499.2W |
| | | | Convection | 320.4W | 319.5W | 320.4W | 321.6W | 321.3W | 320.4W | 321.6W |
| | | - C | 25CFM | 499.2W | 499.5W | 500.4W | 499.2W | 499.5W | 500.4W | 499.2W |
| | | | Convection | 309.6W | 310.5W | 309.6W | 309.6W | 310.5W | 309.6W | 312W |
| | - TF/SF | Built-in fan | 499.2W | 499.5W | 500.4W | 499.2W | 499.5W | 500.4W | 499.2W | |
| | PEAK POWER(3sec.) | | 550W | | | | | | | |
| | RIPPLE & NOISE (max.) Note.2 | | 200mVp-p | | | | | | | |
| | VOLTAGE ADJ. RANGE(main output) | | 11.4~12.6V 14.3~15.8V 17.1~18.9V 22.8~25.2V 25.6~28.4V 34.2~37.8V 45.6~50.4V | | | | | | | |
| VOLTAGE TOLERANCE Note.3 | | ±3.0% ±3.0% ±3.0% ±2.0% ±2.0% ±1.0% ±1.0% | | | | | | | | |
| LINE REGULATION | | ±0.5% ±0.5% ±0.5% ±0.5% ±0.5% ±0.5% ±0.5% | | | | | | | | |
| LOAD REGULATION | | ±1.0% ±1.0% ±1.0% ±1.0% ±1.0% ±1.0% ±1.0% | | | | | | | | |
| SETUP, RISE TIME | | 1000ms, 30ms/230VAC 1500ms, 30ms/115VAC at full load | | | | | | | | |
| HOLD UP TIME (Typ.) | | 10ms/230VAC 10ms/115VAC at full load | | | | | | | | |
| INPUT | VOLTAGE RANGE Note.4 | | 80 ~ 264VAC 113 ~ 370VDC | | | | | | | |
| | FREQUENCY RANGE | | 47 ~ 63Hz | | | | | | | |
| | POWER FACTOR | | PF>0.94/230VAC PF>0.98/115VAC at full load | | | | | | | |
| | EFFICIENCY (Typ.) | | 91% 92% 92.5% 93% 93.5% 94% 94% | | | | | | | |
| | AC CURRENT (Typ.) | | 5.8A/115VAC 2.9A/230VAC | | | | | | | |
| | INRUSH CURRENT (Typ.) | | COLD START 40A/115VAC 80A/230VAC | | | | | | | |
| | LEAKAGE CURRENT (max.) Note.5 | | Earth leakage current <220μA/264VAC 50Hz , Touch current < 100μA/264VAC | | | | | | | |
| PROTECTION | OVERLOAD | | 105 ~ 135% rated output power Protection type : Hiccup mode, recovers automatically after fault condition is removed | | | | | | | |
| | OVER VOLTAGE | | 13.2 ~ 15.6V 16.5 ~ 19.5V 19.8 ~23.4V 26.4 ~ 31.2V 29.7 ~ 35.1V 39.6 ~ 46.8V 52.8 ~ 62.4V Protection type : Hiccup mode, recovers automatically after fault condition is removed | | | | | | | |
| | OVER TEMPERATURE | | Protection type : Shut down o/p voltage, recovers automatically after temperature goes down | | | | | | | |
| FUNCTION | 5V STANDBY | | 5Vsb : 5V@0.6A without fan, 1A with fan 25CFM ; Tolerance ±2%, ripple : 120mVp-p(max.) | | | | | | | |
| | 12V FAN SUPPLY | | 12V@0.5A for driving fan ; Tolerance -15% ~+10% at main output 20% rated current (25CFM) | | | | | | | |
| | FAN CONTROL | | Fan on by 20% load min. (For RPS-500-xxTF/SF) | | | | | | | |
| | PS-ON INPUT SIGNAL | | Power ON: PS-ON = "Hi" or "> 2 ~ 5V" ; Power OFF: PS-ON = "Low" or "< 0 ~ 0.5V" | | | | | | | |
| | POWER GOOD / POWER FAIL | | 500ms>PG>10ms ; The TTL signal goes high with 10ms to 500ms delay after power set up ; The TTL signal goes low at least 1ms before Vo below 90% of rated value | | | | | | | |
| ENVIRONMENT | WORKING TEMP. | | -30 ~ +70°C (Refer to "Derating Curve") | | | | | | | |
| | WORKING HUMIDITY | | 20 ~ 90% RH non-condensing | | | | | | | |
| | STORAGE TEMP. | | -40 ~ +85°C | | | | | | | |
| | TEMP. COEFFICIENT | | ±0.03%/°C (0 ~ 50°C) | | | | | | | |
| | VIBRATION | | 10 ~ 500Hz, 2G 10min./1cycle, 60min. each along X, Y, Z axes | | | | | | | |
| OPERATING ALTITUDE Note.6 | | 4000 meters | | | | | | | | |

SPECIFICATION

| | | | | | | | | | | | | | | |
|--|----------------------|---|-------------------------|--|--|----------------------|------------|----------|-------------------|---------|---------|------------------|---------|---------|
| SAFETY & EMC (Note 8) | SAFETY STANDARDS | IEC60601-1, TUV BS EN/EN60601-1, UL ANSI / AAMI ES60601-1 (3.1 version), EAC TP TC 020. CAN/CSA-C22.2 No. 60601-1:14 - Edition 3 approved; Design refer to BS EN/EN60335-1 (By request) | | | | | | | | | | | | |
| | ISOLATION LEVEL | Primary-Secondary: 2xMOPP, Primary-Earth: 1xMOPP, Secondary-Earth: 1xMOPP | | | | | | | | | | | | |
| | WITHSTAND VOLTAGE | I/P-O/P: 4KVAC I/P-FG: 2KVAC O/P-FG: 1.5KVAC | | | | | | | | | | | | |
| | ISOLATION RESISTANCE | I/P-O/P, I/P-FG: 100M Ohms / 500VDC / 25°C / 70% RH | | | | | | | | | | | | |
| | EMC EMISSION | Parameter | Standard | | Test Level / Note | | | | | | | | | |
| | | Conducted emission | BS EN/EN55011 (CISPR11) | | Class I : Class B , Class II : Class A | | | | | | | | | |
| | | Radiated emission | BS EN/EN55011 (CISPR11) | | Class A | | | | | | | | | |
| | | Harmonic current | BS EN/EN61000-3-2 | | Class A | | | | | | | | | |
| | EMC IMMUNITY | Voltage flicker | BS EN/EN61000-3-3 | | ----- | | | | | | | | | |
| | | BS EN/EN55035 , BS EN/EN60601-1-2, BS EN/EN61204-3 | | | | | | | | | | | | |
| Parameter | | Standard | | Test Level / Note | | | | | | | | | | |
| ESD | | BS EN/EN61000-4-2 | | Level 4, 15KV air ; Level 4, 8KV contact | | | | | | | | | | |
| RF field susceptibility | | BS EN/EN61000-4-3 | | Level 3, 10V/m(80MHz~2.7GHz) Table 9, 9~28V/m(385MHz~5.78GHz) | | | | | | | | | | |
| EFT bursts | | BS EN/EN61000-4-4 | | Level 3, 2KV | | | | | | | | | | |
| Surge susceptibility | | BS EN/EN61000-4-5 | | Level 4, 4KV/Line-FG ; 2KV/Line-Line | | | | | | | | | | |
| Conducted susceptibility | | BS EN/EN61000-4-6 | | Level 3, 10V | | | | | | | | | | |
| OTHERS | MTBF | 1132.3K hrs min. Telcordia SR-332 (Bellcore) ; 144.2K hrs min. MIL-HDBK-217F (25°C) | | | | | | | | | | | | |
| | | DIMENSION | Type | RPS-500 | RPS-500-C | RPS-500-TF | RPS-500-SF | | | | | | | |
| | PACKING | L*W*H | 127x76.2x41mm | 130x86x43mm | 130x86x58.5mm | 160x86x43mm | | | | | | | | |
| | | | 5"×3"×1.61"inch | 5.11"×3.39"×1.69"inch | 5.11"×3.39"×2.30"inch | 6.3"×3.39"×1.69"inch | | | | | | | | |
| | | P.W. | 0.46Kg | 0.54Kg | 0.58Kg | 0.64Kg | | | | | | | | |
| Q'TY | | 30pcs | 24pcs | 24pcs | 24pcs | | | | | | | | | |
| NOTE | G.W. | 14.8Kg | 14Kg | 14.9Kg | 16.4Kg | | | | | | | | | |
| | M'MENT | 0.96CUFT | 0.77CUFT | 0.86CUFT | 0.91CUFT | | | | | | | | | |
| <p>1. All parameters NOT specially mentioned are measured at 230VAC input, rated load and 25 of ambient temperature.</p> <p>2. Ripple & noise are measured at 20MHz of bandwidth by using a 12" twisted pair-wire terminated with a 0.1μf & 47μf parallel capacitor.</p> <p>3. Tolerance : includes set up tolerance, line regulation and load regulation.</p> <p>4. Derating may be needed under low input voltages. Please check the derating curve for more details.</p> <p>5. Touch current was measured from primary input to DC output.</p> <p>6. The ambient temperature derating of 3.5°C/1000m with fanless models and of 5°C/1000m with fan models for operating altitude higher than 2000m(6500ft).</p> <p>7. Please refer to "Derating curve".</p> <p>8. The power supply is considered a component which will be installed into a final equipment. All EMC tests are executed by mounting the unit on a 360mm×360mm metal plate with 1mm of thickness. The final equipment must be re-confirmed that it still meets EMC directives. For guidance on how to perform these EMC tests, please refer to "EMI testing of component power supplies." (as available on http://www.meanwell.com).</p> <p>※ Product Liability Disclaimer : For detailed information, please refer to https://www.meanwell.com/serviceDisclaimer.aspx</p> <table border="1" style="width: 100%; border-collapse: collapse;"> <tr> <td>EMI Performance</td> <td>Conducted</td> <td>Radiated</td> </tr> <tr> <td>Class I (with FG)</td> <td>Class B</td> <td>Class A</td> </tr> <tr> <td>Class II (no FG)</td> <td>Class A</td> <td>Class A</td> </tr> </table> | | | | | | EMI Performance | Conducted | Radiated | Class I (with FG) | Class B | Class A | Class II (no FG) | Class A | Class A |
| EMI Performance | Conducted | Radiated | | | | | | | | | | | | |
| Class I (with FG) | Class B | Class A | | | | | | | | | | | | |
| Class II (no FG) | Class A | Class A | | | | | | | | | | | | |



500W 5"×3" Reliable Green Medical Power Supply **RPS-500** series

Block Diagram

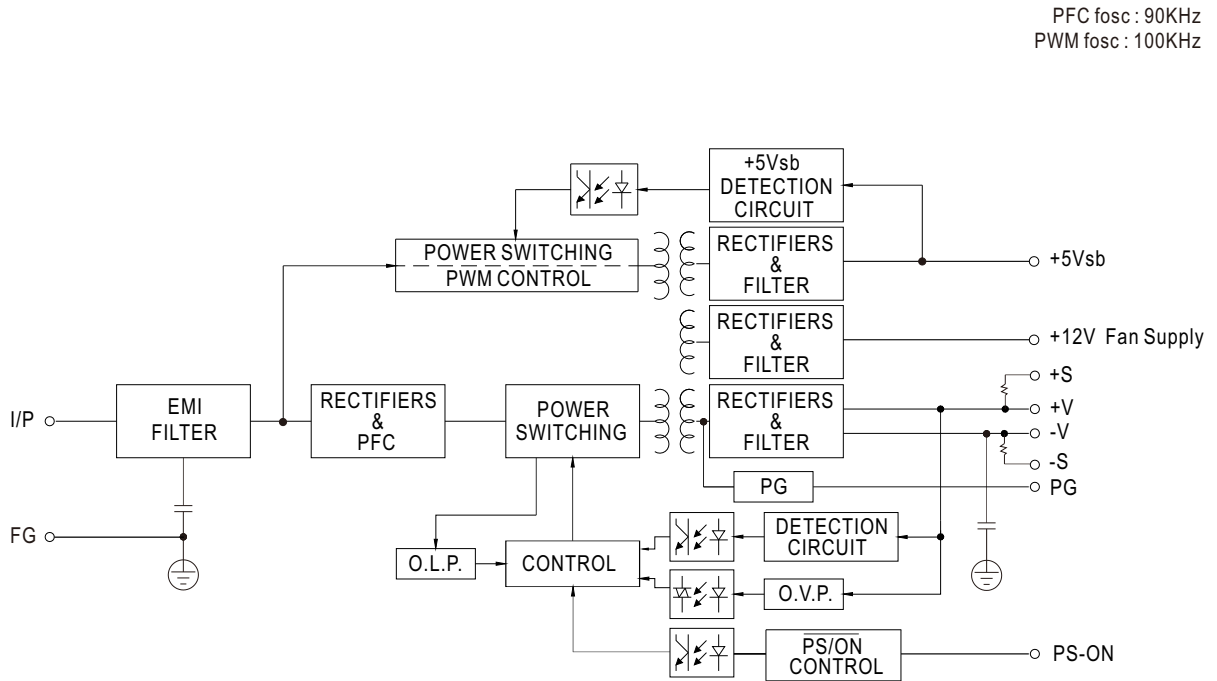

Output Derating vs Input Voltage

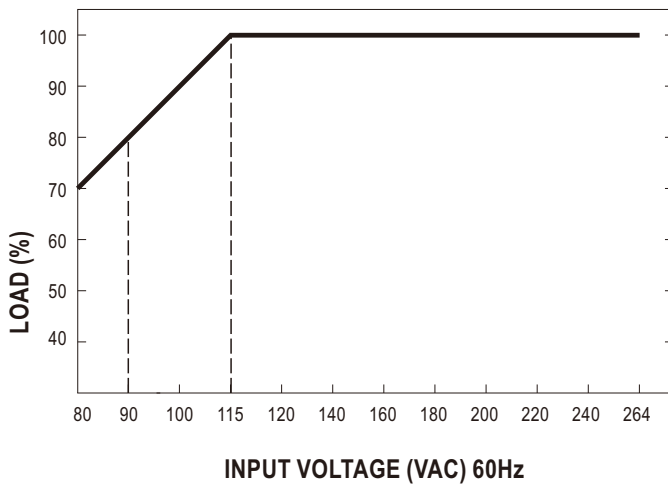

Derating Curve

○ **RPS-500**

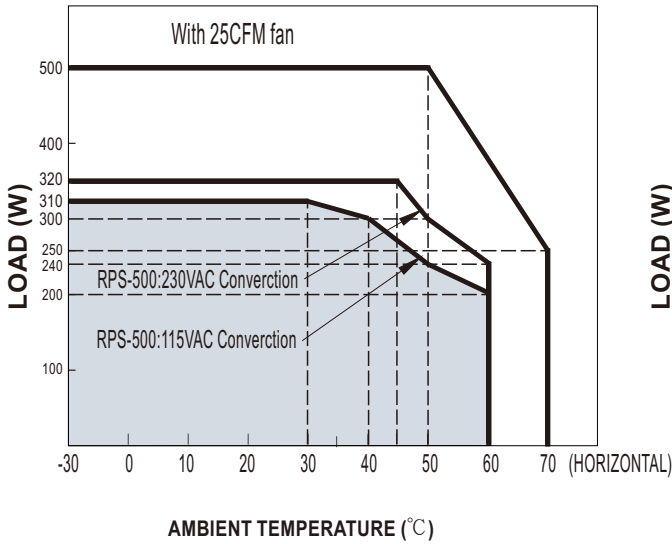

○ **RPS-500-C**

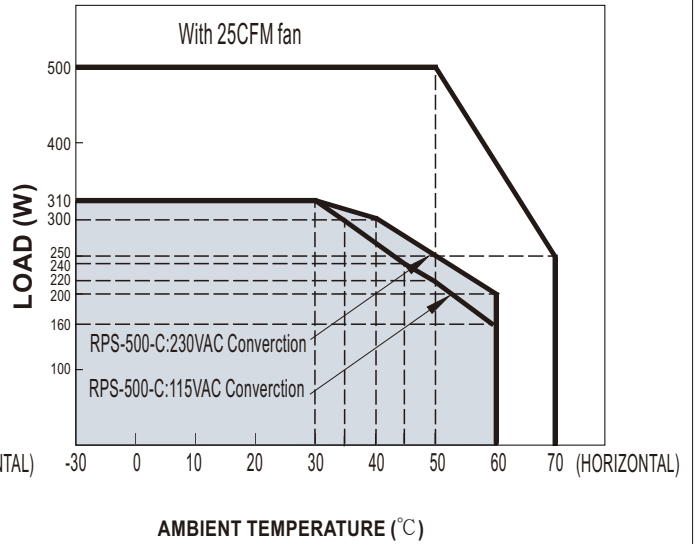

○ **RPS-500-TF/SF**

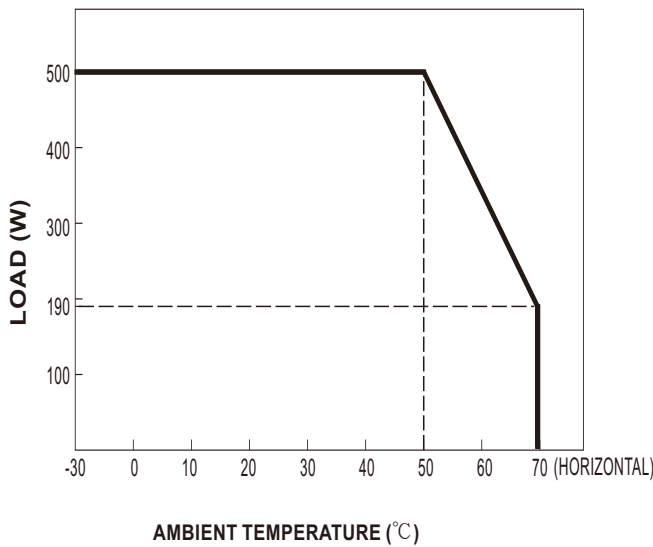

| Order No. | RPS-500 | RPS-500-C | RPS-500-TF | RPS-500-SF |
|------------|---------|-----------|------------|------------|
| Products | | | | |
| Convection | 320W | 310W | --- | --- |
| Force Air | 500W | 500W | 500W | 500W |

■ Mechanical Specification

● RPS-500 (PCB Type)

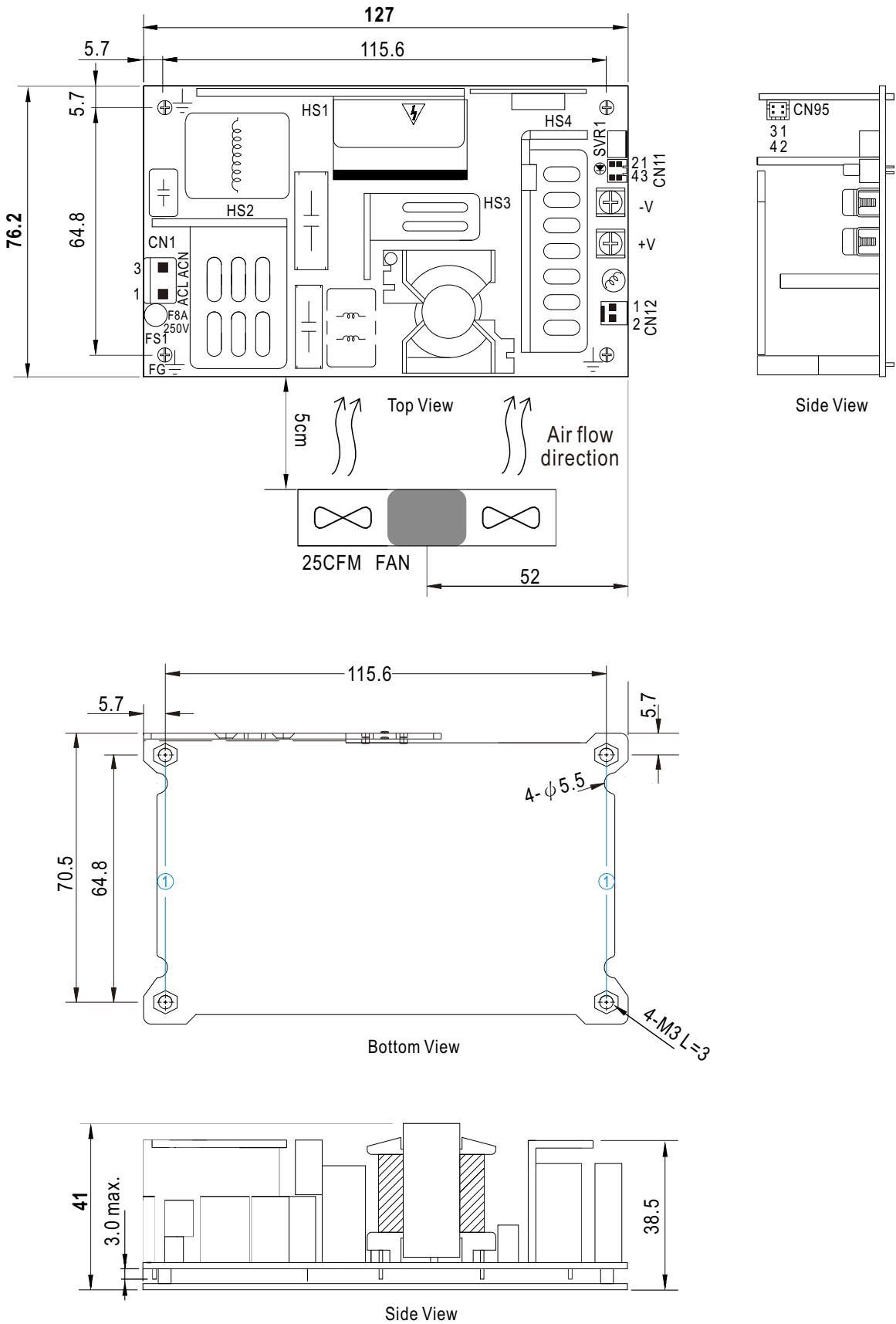

● RPS-500-C (Enclosed type)

Case No. 247C-T 269A-D Unit:mm

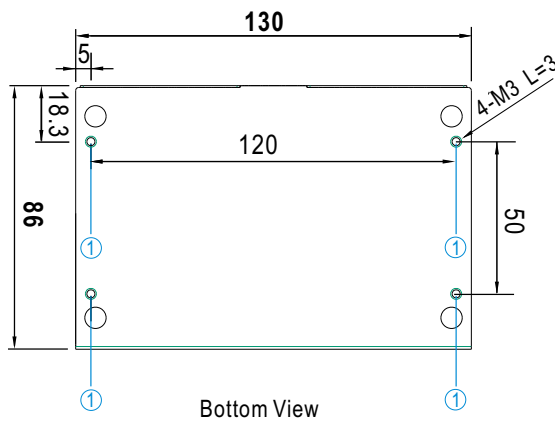
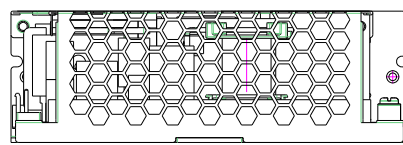
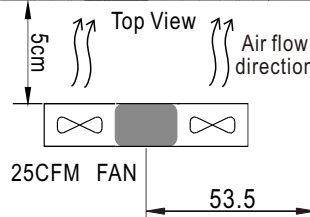
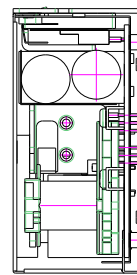
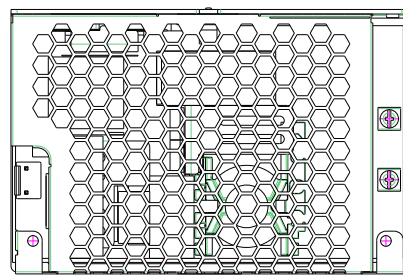
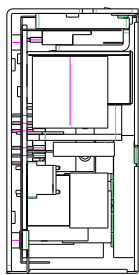
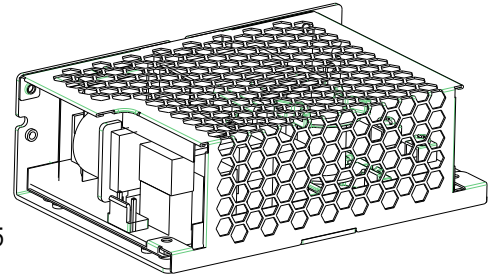
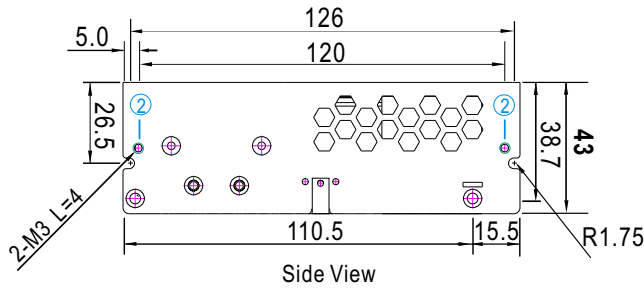



500W 5"×3" Reliable Green Medical Power Supply **RPS-500** series

● RPS-500-TF (Enclosed type with fan on the top)

Case No. 269A-D 247D-T Unit:mm

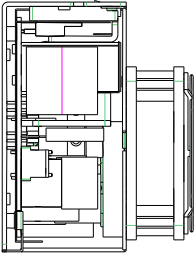
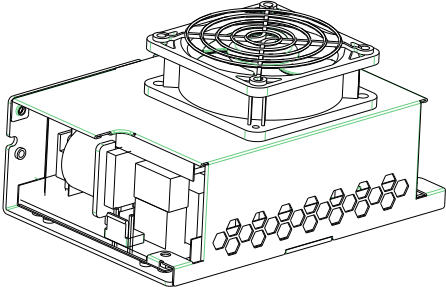
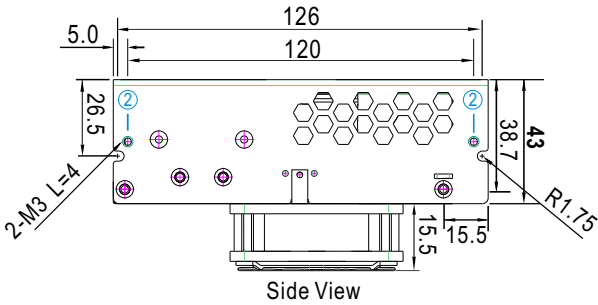

Side View

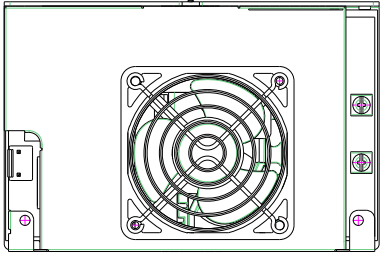

Top View

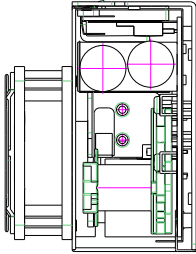

Side View

↕ Air flow direction

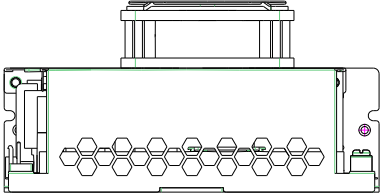

Side View

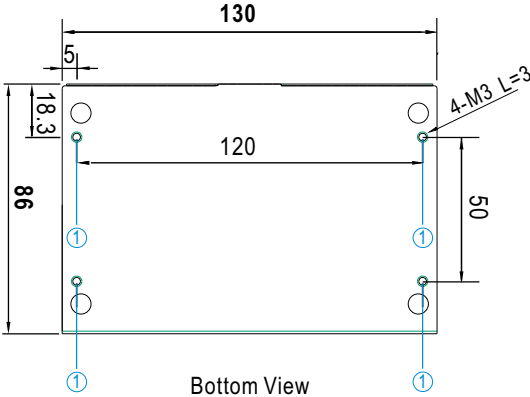



500W 5"×3" Reliable Green Medical Power Supply **RPS-500** series

● RPS-500-SF (Enclosed type with fan on the side)

Case No. 248B Unit:mm

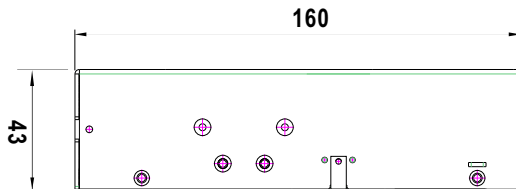
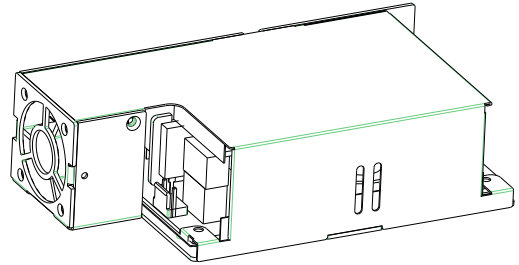

Side View

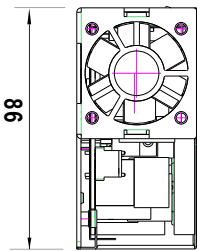

Side View

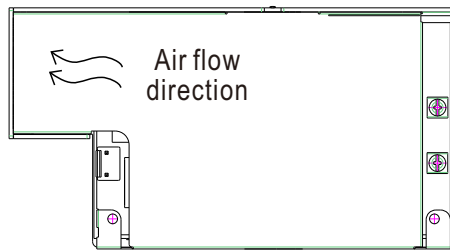

Top View

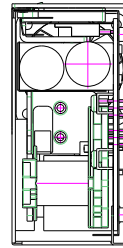

Side View

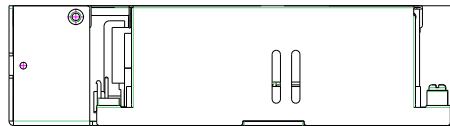

Side View

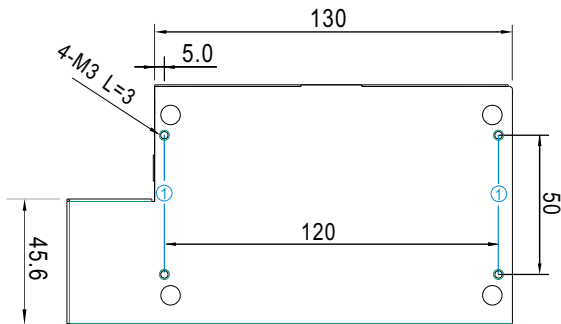

Bottom View

※ **Mounting Instruction for -C/-TF/-SF Type**

| Hole No. | Recommended Screw Size | MAX. Penetration Depth L | Recommended mounting torque |
|----------|------------------------|--------------------------|-----------------------------|
| ① | M3 | 3mm | 4~6Kgf-cm |
| ② | M3 | 4mm | 4~6Kgf-cm |

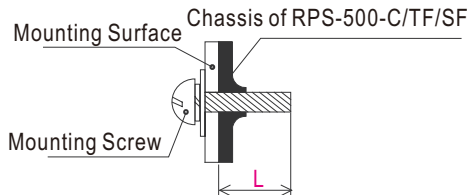

※ **CONNECTION**

AC Input Connector (CN1) : JST B3P-VH or equivalent

| Pin No. | Assignment | Mating Housing | Terminal |
|---------|------------|--------------------------|-----------------------------------|
| 1 | AC/L | JST VHR or equivalent | JST SVH-21T-P1.1 or equivalent |
| 2 | No Pin | | |
| 3 | AC/N | | |

Function Connector(CN11): TKP DH2I-2X2 or equivalent

| Pin No. | Assignment | Mating Housing | Terminal |
|---------|------------|--------------------------|----------------------|
| 1 | -S | TKP DH2 or equivalent | TKP or equivalent |
| 2 | +S | | |
| 3 | DC COM | | |
| 4 | PG | | |

DC Output Connector (CN2,CN3)

| Pin No. | Assignment | Output Terminals |
|---------|------------|---|
| CN2 | -V | M3.5 Pan HD screw in 2 positions Torque to 8 lbs-in(90cNm)max. |
| CN3 | +V | |

Function Connector(CN95): TKP DH2L-2X2 or equivalent

| Pin No. | Assignment | Mating Housing | Terminal |
|---------|------------|--------------------------|----------------------|
| 1 | 5Vsb | TKP DH2 or equivalent | TKP or equivalent |
| 2,4 | DC COM | | |
| 3 | PS-ON | | |

⚠ HS1,HS2,HS3,HS4 can not be shorted

FAN Connector(CN12) : TKP 8812-2 or equivalent
(Except for RPS-500-TF/SF)

| Pin No. | Assignment | Mating Housing | Terminal |
|---------|------------|---------------------------|---------------------------|
| 1 | DC COM | TKP 2502 or equivalent | TKP 8811 or equivalent |
| 2 | +12V | | |

- ※ Note: 1. The enclosed type (-C/TF/SF type) models are not suitable for configuration within a Class II (without FG) system, but suggested within a Class I (with FG) system.
2. Mounting Instruction for enclosed type.

■ **Installation Manual**

Please refer to : <http://www.meanwell.com/manual.html>