

# **QT-Brightek Lamp Series**

## **5mm Round Lamp**

**Part No.: QBL8IW30C-XX**

**XX (Color Code) = WW/NW/CW**

---

**Table of Contents:**

Introduction .....	3
Electrical / Optical Characteristic (Ta=25 °C) .....	4
Absolute Maximum Rating .....	4
CIE Chromaticity Diagram.....	5
Characteristic Curves.....	8
Ordering Information .....	9
Revision History .....	10
Disclaimer .....	10

**Introduction**

**Feature:**

- Clear lens
- Packed in bulk
- 5mm round lamp
- InGaN technology
- Viewing angle: 30° typ.

**Description:**

These bright 5mm round type lamps are suitable for all indicator applications such as electronic signs and electronic board indicator.

**Application:**

- General purpose indicator application
- Electronic signs and electronics board
- Indicator

**Certification & Compliance:**

- TS16949
- ISO9001
- RoHS Compliant



**Dimension:**

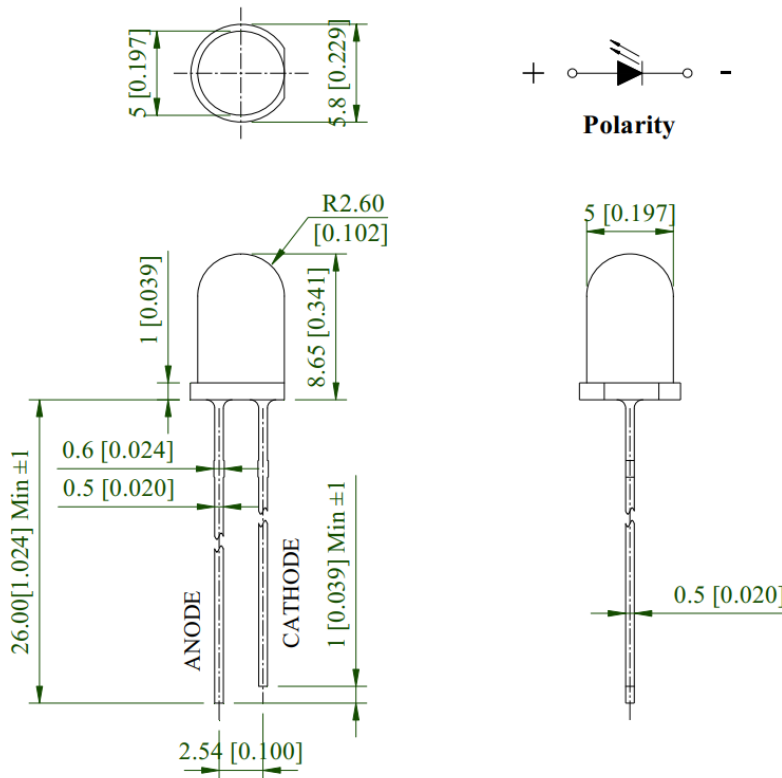

**Polarity**

Units: mm / general tolerance = +/-0.25mm unless otherwise specified

**Electrical / Optical Characteristic (Ta=25 °C)**

Product	Color	I <sub>F</sub> (mA)	V <sub>F</sub> (V)		Chromaticity Coordinate			I <sub>V</sub> (mcd)	
			Typ.	Max.	Min.	Typ.	Max.	Min.	Typ.
QBL8IW30C-WW	Warm White	20	3.1	3.6	-	X=0.43 Y=0.395	-	5000	8500
QBL8IW30C-NW	Natural White	20	3.1	3.6		X=0.335 Y=0.325		6500	11000
QBL8IW30C-CW	Cool White	20	3.1	3.6	-	X=0.28 Y=0.28	-	5000	8500

**Absolute Maximum Rating**

Material	P <sub>d</sub> (mW)	I <sub>F</sub> (mA)	I <sub>FP</sub> (mA)*	V <sub>R</sub> (V)	T <sub>OP</sub> (°C)	T <sub>ST</sub> (°C)	T <sub>SOL</sub> (°C)**
InGaN	95	25	100	5	-40 to +85	-40 to +100	260

\*Pulse width 0.1msec, duty 1/10

\*\*Wave Soldering for no more than 3 sec @ 260 °C

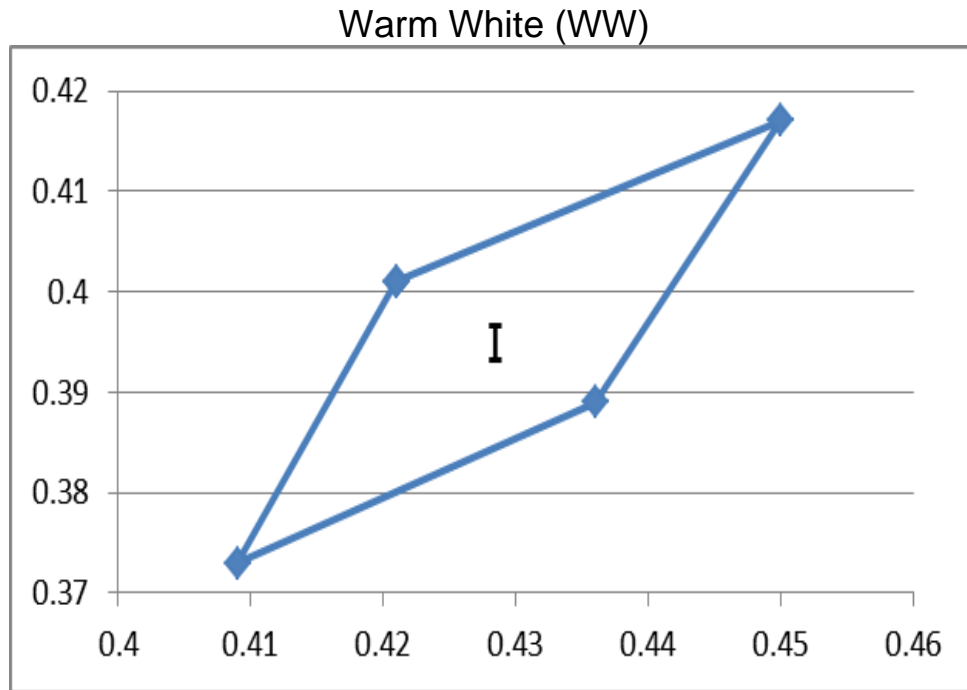
**CIE Chromaticity Diagram**

I	
X	Y
0.421	0.401
0.45	0.417
0.436	0.389
0.409	0.373
0.421	0.401

Natural White (NW)

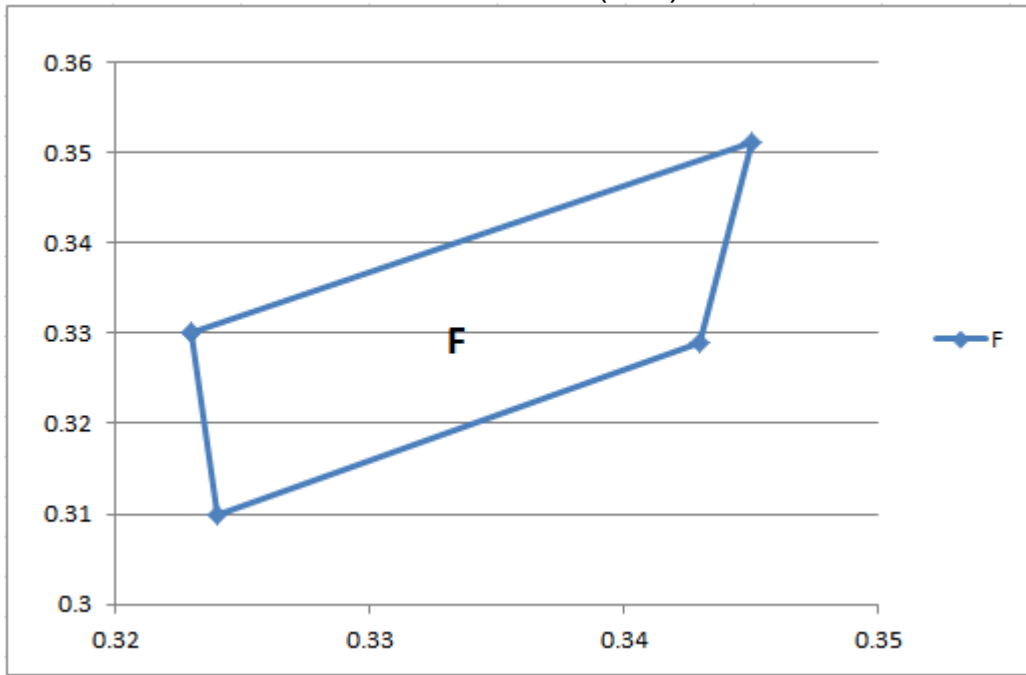

F	
X	Y
0.323	0.33
0.345	0.351
0.343	0.329
0.324	0.31
0.323	0.33

Cool White (CW)

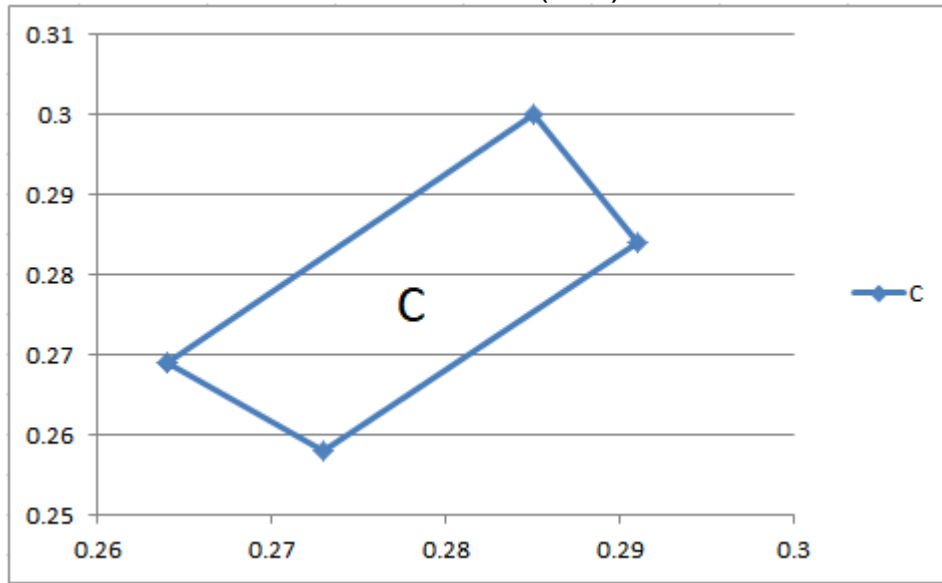

C	
X	Y
0.264	0.269
0.273	0.258
0.291	0.284
0.285	0.3
0.264	0.269

Tolerance of measurement of color coordinates:  $\pm 0.01$

## Characteristic Curves

Forward Current & Forward Voltage

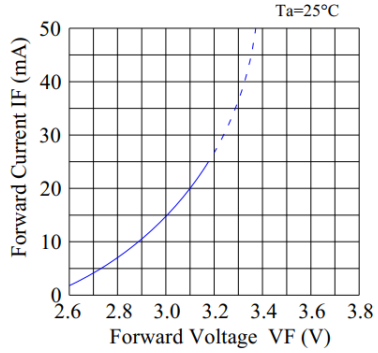

Luminous Intensity & Forward Current

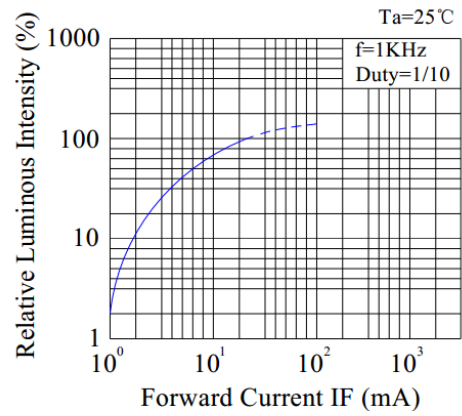

Forward Current Derating Curve

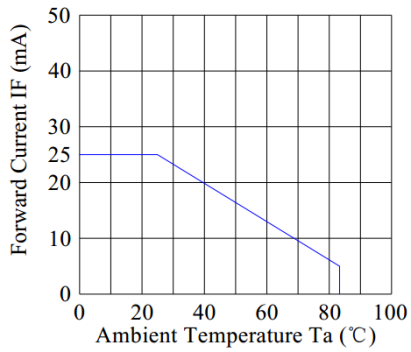

Luminous Intensity & Ambient Temperature

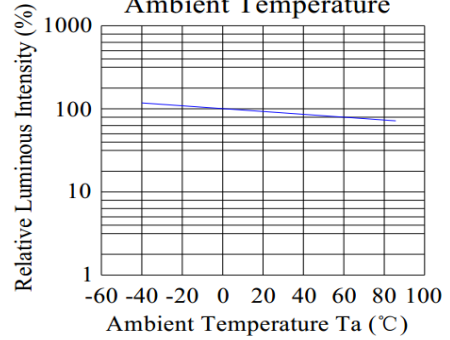

Radiation Diagram

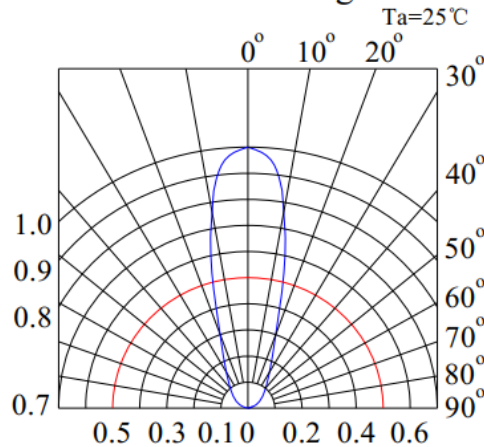



---

**Ordering Information**

Part #	Orderable Part #	Spec Range	Quantity per bag
QBL8IW30C-WW	QBL8IW30C-WW	Iv=8500mcd typ. @ 20mA, CCT Coordinate : (0.43, 0.395) typ.	500pcs
QBL8IW30C-NW	QBL8IW30C-NW	Iv=11000mcd typ. @ 20mA, CCT Coordinate : (0.335, 0.325) typ.	500pcs
QBL8IW30C-CW	QBL8IW30C-CW	Iv=8500mcd typ. @ 20mA, CCT Coordinate : (0.28, 0.28) typ.	500pcs

**Revision History**

Description:	Revision #	Revision Date
New Release of QBL8IW30C-XX	V1.0	02/09/2018

**Disclaimer**

QT-BRIGHTTEK reserves the right to make changes without further notice to any products herein to improve reliability, function or design. QT-BRIGHTTEK does not assume any liability arising out of the application or use of any product or circuit described herein; neither does it convey any license under its patent rights, nor the rights of others.

**Life Support Policy**

QT-BRIGHTTEK's products are not authorized for use as critical components in life support devices or systems without the express written approval of QT-BRIGHTTEK. As used herein:

1. Life support devices or systems are devices or systems which, (a) are intended for surgical implant into the body, or (b) support or sustain life, and (c) whose failure to perform when properly used in accordance with instructions for use provided in the labeling, can be reasonably expected to result in a significant injury of the user.
2. A critical component in any component of a life support device or system whose failure to perform can be reasonably expected to cause the failure of the life support device or system, or to affect its safety or effectiveness.