

WR-51 Standard Gain Horn with 10 dBi gain, SMA Female connector

## Technical Data Sheet

**PEWAN051-10SF**

### Mechanical Specifications

#### Size

Length	2.538 in [64.47 mm]
Width	1.31 in [33.27 mm]
Height	1.31 in [33.27 mm]
Weight	0.163 lbs [73.94 g]

#### RF Connector

Type	SMA Female
------	------------

#### Waveguide Interface

Waveguide Size	WR-51
----------------	-------

### Environmental Specifications

**Compliance Certifications** (see [product page](#) for current document)

### Plotted and Other Data

Notes:

Click the following link (or enter part number in "SEARCH" on website) to obtain additional part information including price, inventory and certifications: [WR-51 Standard Gain Horn with 10 dBi gain, SMA Female connector PEWAN051-10SF](#)

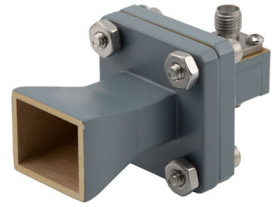

WR-51 Standard Gain Horn with 10 dBi gain, SMA Female connector

## Technical Data Sheet

**PEWAN051-10SF**

### Typical Performance Data

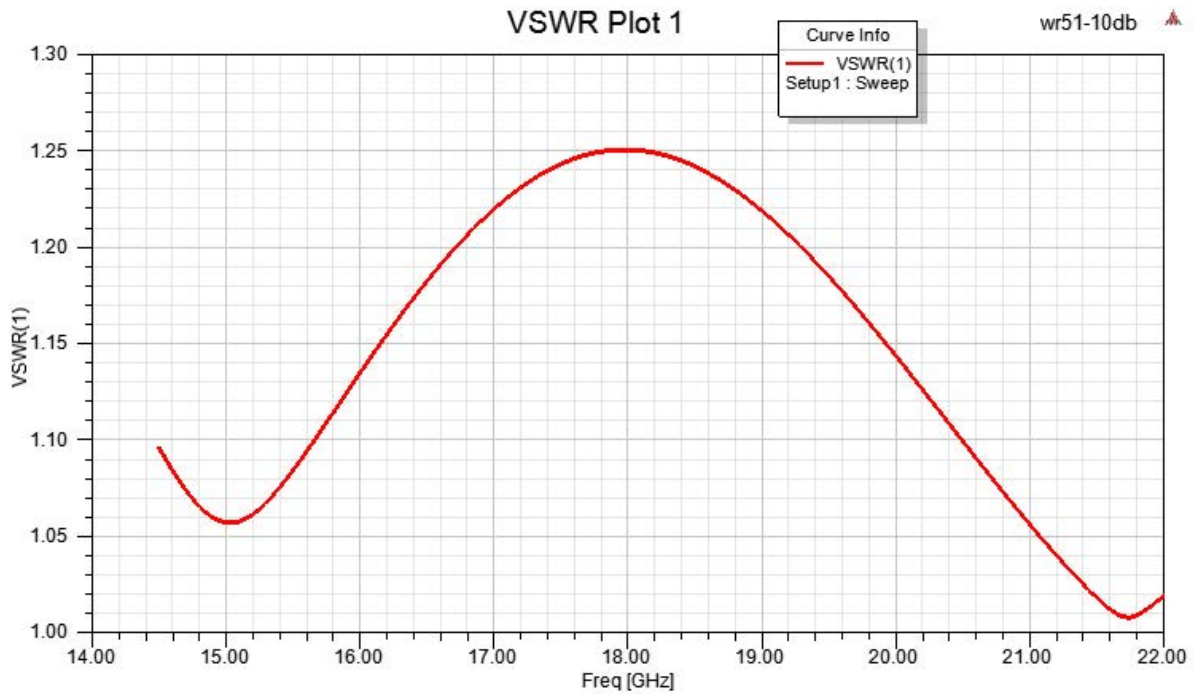

Click the following link (or enter part number in "SEARCH" on website) to obtain additional part information including price, inventory and certifications: [WR-51 Standard Gain Horn with 10 dBi gain, SMA Female connector PEWAN051-10SF](#)

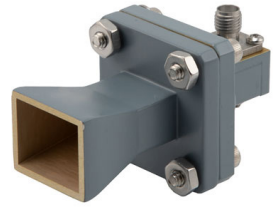

WR-51 Standard Gain Horn with 10 dBi gain, SMA Female connector

**Technical Data Sheet**

**PEWAN051-10SF**

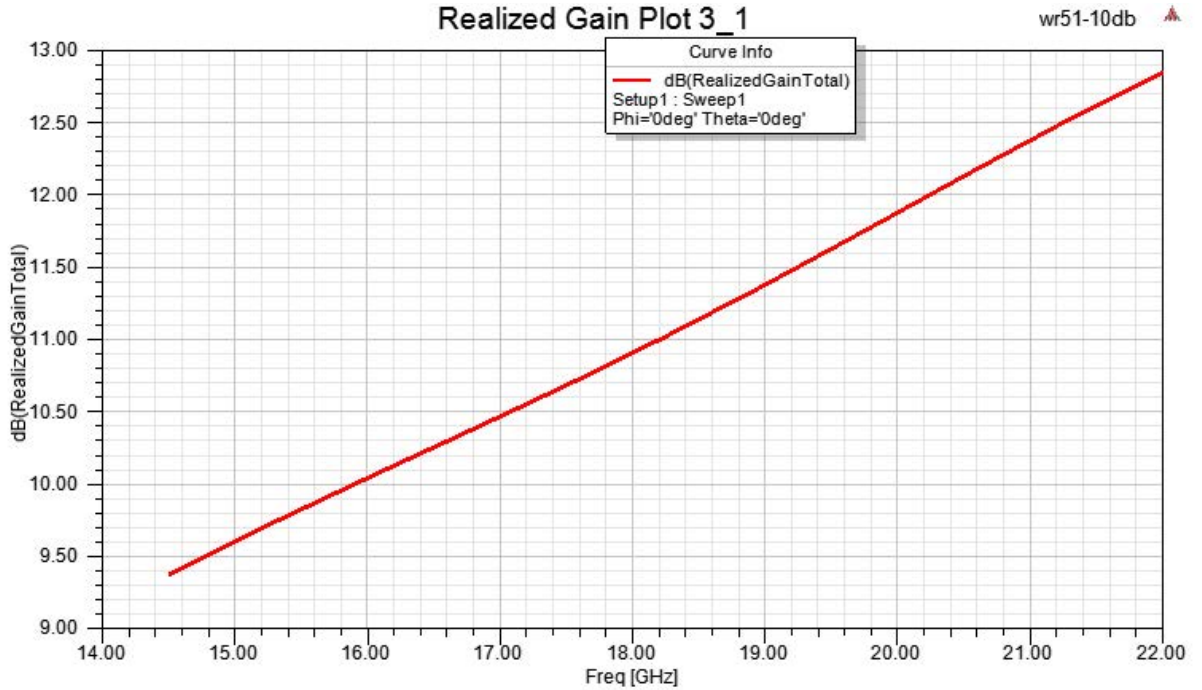

Click the following link (or enter part number in "SEARCH" on website) to obtain additional part information including price, inventory and certifications: [WR-51 Standard Gain Horn with 10 dBi gain, SMA Female connector PEWAN051-10SF](#)

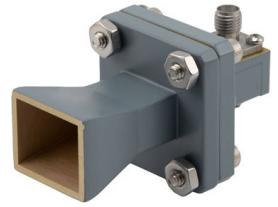

WR-51 Standard Gain Horn with 10 dBi gain, SMA Female connector

**Technical Data Sheet**

**PEWAN051-10SF**

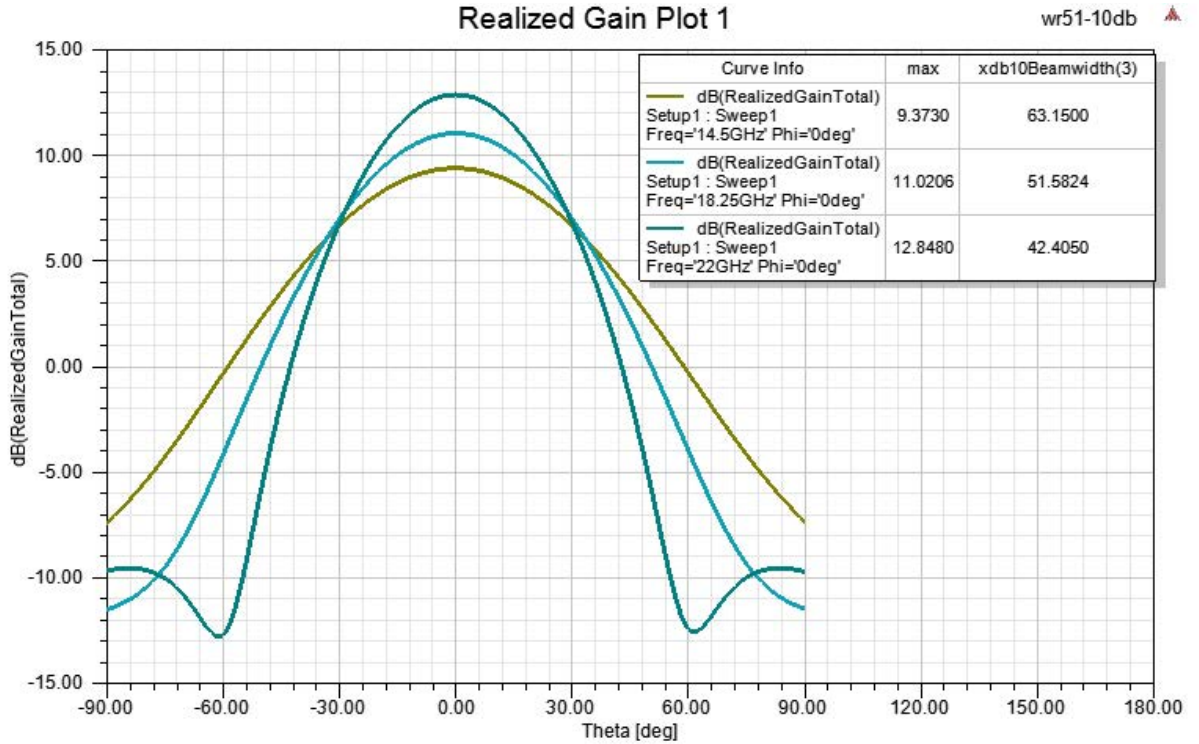

Click the following link (or enter part number in "SEARCH" on website) to obtain additional part information including price, inventory and certifications: [WR-51 Standard Gain Horn with 10 dBi gain, SMA Female connector PEWAN051-10SF](#)

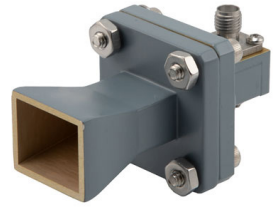

WR-51 Standard Gain Horn with 10 dBi gain, SMA Female connector

**Technical Data Sheet**

**PEWAN051-10SF**

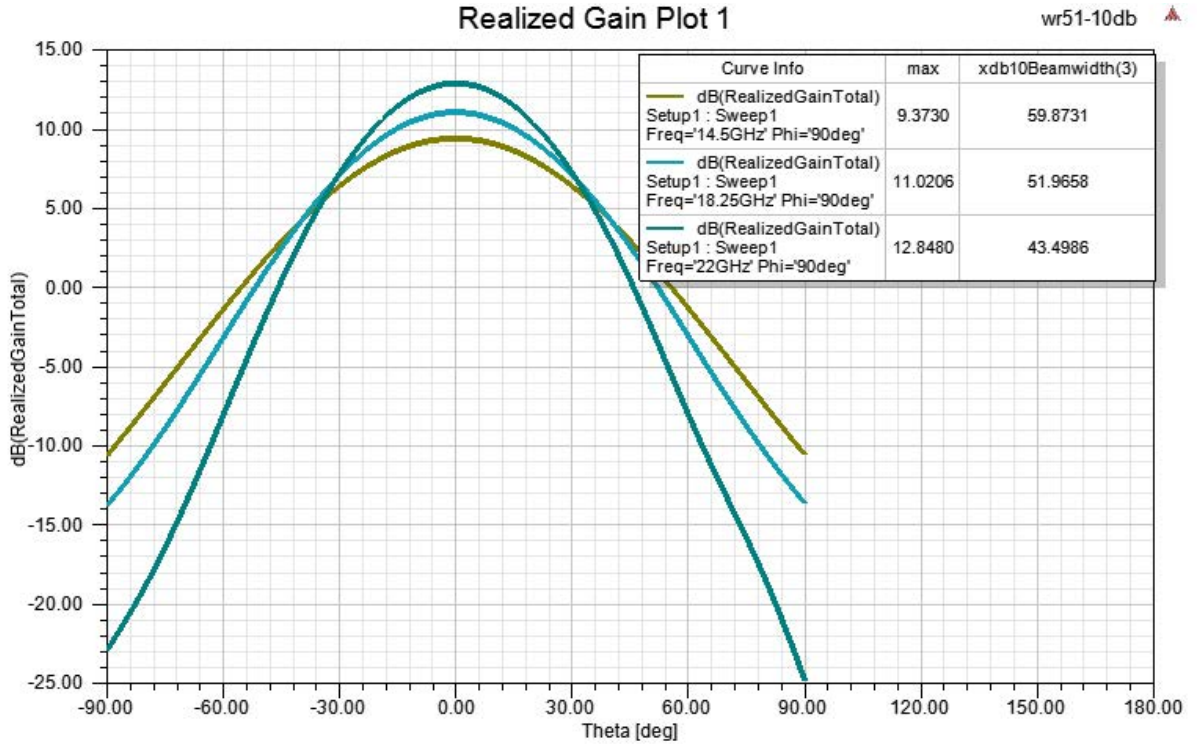

WR-51 Standard Gain Horn with 10 dBi gain, SMA Female connector from Pasternack Enterprises has same day shipment for domestic and International orders. Our RF, microwave and millimeter wave products maintain a 99.4% availability and are part of the broadest selection in the industry.

Click the following link (or enter part number in "SEARCH" on website) to obtain additional part information including price, inventory and certifications: [WR-51 Standard Gain Horn with 10 dBi gain, SMA Female connector PEWAN051-10SF](#)

URL:

The information contained in this document is accurate to the best of our knowledge and representative of the part described herein. It may be necessary to make modifications to the part and/or the documentation of the part, in order to implement improvements. Pasternack reserves the right to make such changes as required. Unless otherwise stated, all specifications are nominal. Pasternack does not make any representation or warranty regarding the suitability of the part described herein for any particular purpose, and Pasternack does not assume any liability arising out of the use of any part or documentation.

# PEWAN051-10SF CAD Drawing

WR-51 Standard Gain Horn with 10 dB gain, SMA Female connector

REVISIONS			
REV.	DESCRIPTION	DATE	APPROVED
A	INITIAL RELEASE	10/04/2021	KHIETPAS

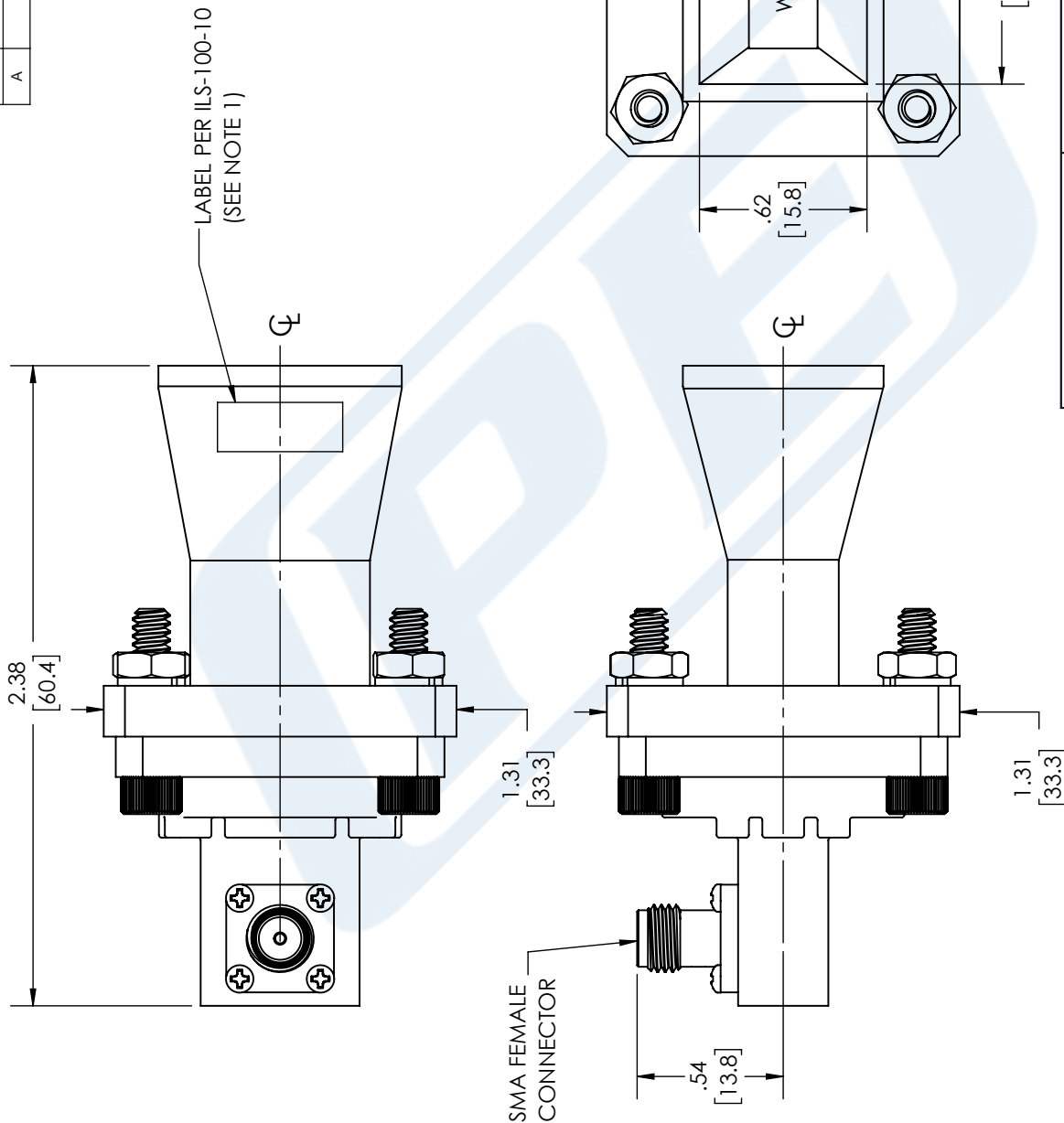

**PE PASTERNAK**  
an INFINITI® brand

Pasternack Enterprises, Inc.  
P. O. Box 16759, Irvine, CA 92623.  
Phone: 1.949.261.1920 | 1.866.727.8376  
Fax: 1.949.261.7451  
Website: www.pasternack.com  
E-mail: sales@pasternack.com

THIRD-ANGLE PROJECTION

THE INFORMATION AND DESIGN IN THIS DOCUMENT IS THE PROPERTY OF PASTERNAK CORPORATION. ALL RIGHTS RESERVED.

SHEET 1 OF 1

SCALE N/A

---

UNLESS OTHERWISE SPECIFIED LEADING DIMENSIONS ARE INCHES DIMENSIONS IN [ ] ARE MILLIMETERS

TOLERANCES:

.X = ±.2 [5.08]    FRACTIONS ± 1/32  
.XX = ±.02 [ .51]    ANGLES ± 1°  
.XXX = ±.005 [ .13]

CABLE LENGTH (L), TOLERANCES:

L ≤ 12 [305] = +1 [25] / -0  
12 [305] < L ≤ 60 [1524] = +2 [51] / -0  
60 [1524] < L ≤ 120 [3048] = +4 [102] / -0  
120 [3048] < L ≤ 300 [7620] = +6 [152] / -0  
300 [7620] < L = +5% / -0

ALL DIMENSIONS SHOWN ARE FOR REFERENCE ONLY.

SIZE [CAGE CODE] DRAWN BY ITEM NO.

A 53919 BPUCHASKI PEWAN051-10SF

**NOTES:**  
1. LABEL PER ILS-100-10 (FOR INTERNAL REFERENCE ONLY)  
LABEL LOCATION FOR REFERENCE ONLY

THESE COMMODITIES, TECHNOLOGY OR SOFTWARE WERE EXPORTED FROM THE UNITED STATES IN ACCORDANCE WITH THE EXPORT ADMINISTRATION REGULATIONS. DIVERSION CONTRARY TO U.S. LAW PROHIBITED.