

Features

Regulated Converter

- OVC III and PD3 up to 5000m altitude
- 85-528VAC input range
- -40°C to +90°C operating temperature:
- LPS limited power source
- EN55032 class “B”; floating outputs
- No load power consumption <0.3W



RAC25-K/480

25 Watt
3.2“ x 1.8“
Single Output



IEC/EN62368-1 certified
UL62368-1 certified
CAN/CSA-C22.2 No. 62368-1-14 certified
IEC/EN61010 certified
IEC/EN60335-1 certified
EN62233 certified
EN55032 compliant
EN55035 compliant
CB Report

Description

The RAC25-K/480 series AC/DC modules with ultra-wide input range of 100-480 VAC are specially designed for harsh industrial conditions of overvoltage category OVC III and pollution degree PD3 in both single-phase and phase-to-phase power connections of class II. These power supplies are capable of operating over a wide temperature range of -40° to 90°C (up to 70°C without derating) to be completed by the addition of an external fuse, offer LPS limited outputs with continuous overcurrent protection, surge immunity to level 3 and emission class B EMC compliance in potential free configurations. The silicone-free encapsulated modules are built extremely compact to fit on printed circuit boards without compromising board area. Global safety certifications ensure fast time-to-market when integrated into applications for markets such as Smart Grid, Smart Metering, Renewable Energy; Sensors and actuators or IoT applications.

Selection Guide

Part Number	Input Voltage Range [VAC]	Output Voltage [VDC]	Output Current [mA]	Efficiency typ ⁽¹⁾ [%]	Max. Capacitive Load ⁽¹⁾ [µF]
RAC25-05SK/480	85-528	5	5000	82	20000
RAC25-12SK/480	85-528	12	2080	84	18000
RAC25-15SK/480	85-528	15	1670	85	6000
RAC25-24SK/480	85-528	24	1040	87	4000

Notes:

Note1: Is tested at 230VAC input and constant resistive load at +25°C ambient

Model Numbering



Specifications (measured @ Ta= 25°C, nom. Vin, full load and after warm-up unless otherwise stated)

BASIC CHARACTERISTICS				
Parameter	Condition	Min.	Typ.	Max.
Nominal Input Voltage ⁽²⁾	50/60Hz	100VAC		277VAC
				480VAC
Input Voltage Range ⁽³⁾	47-63Hz	85VAC		528VAC
	DC	120VDC		750VDC
Input Current	115/230VAC 480VAC			500mA 400mA
Inrush Current	cold start	115VAC		20A
		230VAC		40A
		480VAC		50A

Notes:
 Note2: 480VAC limited to L-L connections
 Note3: The products were submitted for safety files at AC-Input operation

continued on next page

Specifications (measured @ Ta= 25°C, nom. Vin, full load and after warm-up unless otherwise stated)

BASIC CHARACTERISTICS

Parameter	Condition	Min.	Typ.	Max.
No Load Power Consumption	85-528VAC			300mW
Input Frequency Range	AC Input	47Hz		63Hz
Minimum Load		0%		
Power Factor	115VAC	0.45		
	230VAC	0.4		
	480VAC	0.3		
Start-up Time			130ms	
Rise Time			30ms	
Hold-up Time		30ms		
Internal Operating Frequency			50kHz	
Output Ripple and Noise ⁽⁴⁾	20MHz BW	V _{OUT} = 5VDC		100mVp-p
		others		1% of V _{OUT}

Notes:

Note4: Measurements are made with a 0.1µF MLCC & 10µF E-cap in parallel across output (low ESR).

Efficiency vs. Load

RAC25-05SK/480

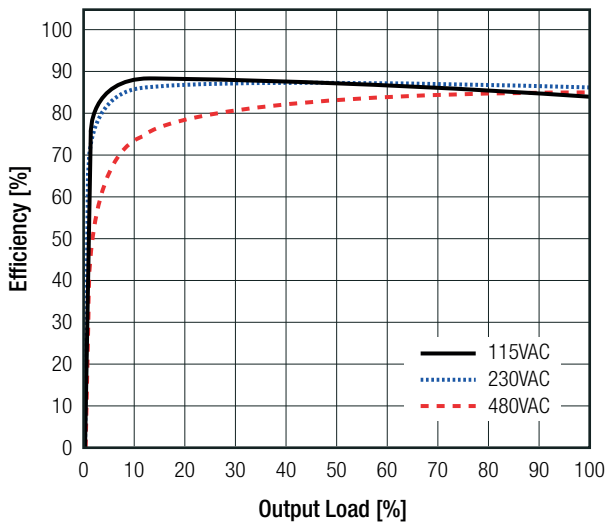

RAC25-12SK/480

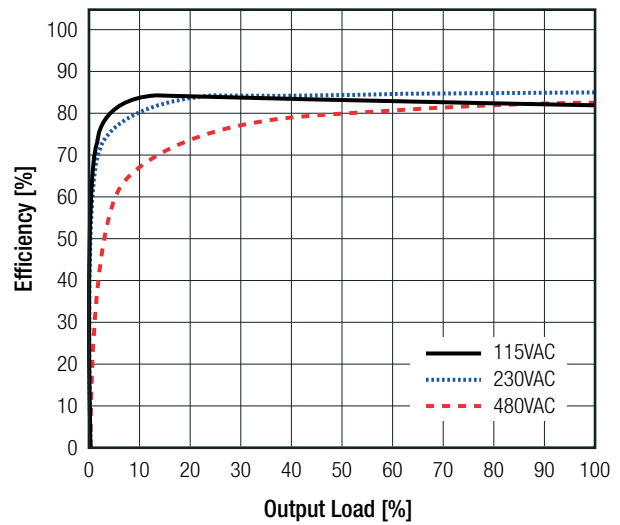

RAC25-15SK/480

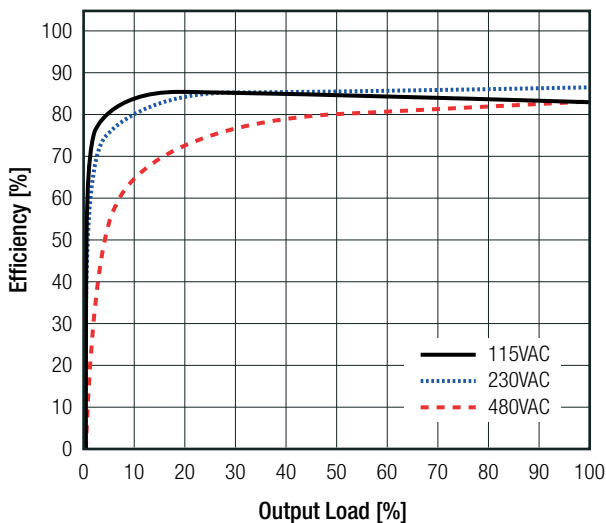

RAC25-24SK/480

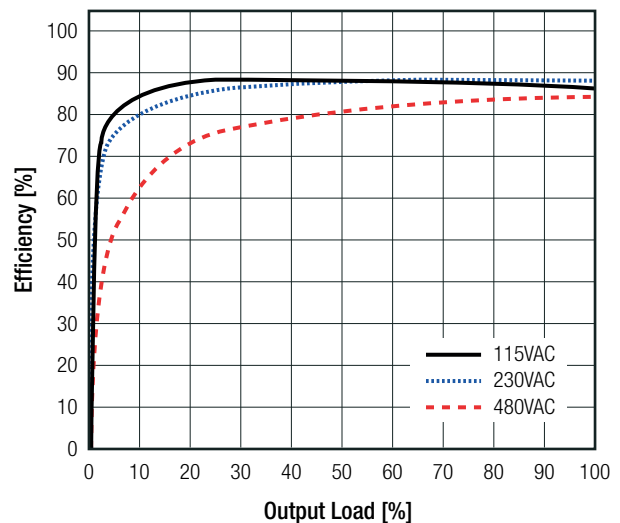

Specifications (measured @ Ta= 25°C, nom. Vin, full load and after warm-up unless otherwise stated)

REGULATIONS

Parameter	Condition	Value
Output Accuracy		±3.0% max.
Line Regulation	low line to high line	±2.0% typ.
Load Regulation ⁽⁵⁾	10% to 100% load	2.0% typ.
Transient Response	25% load step change	4.0% max.
	recovery time	1 ms typ.

Notes:

Note5: Operation below 10% load will not harm the converter, but specifications may not be met

Deviation vs. Load

RAC25-05SK/480

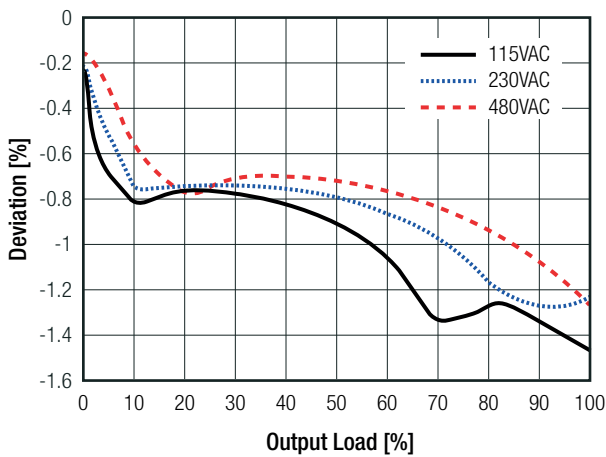

RAC25-12SK/480

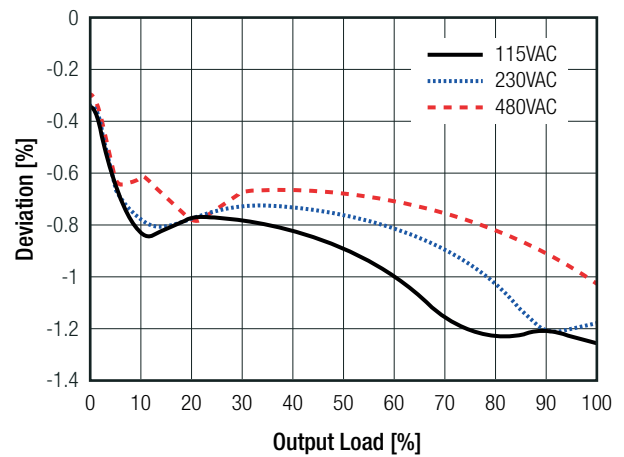

RAC25-15SK/480

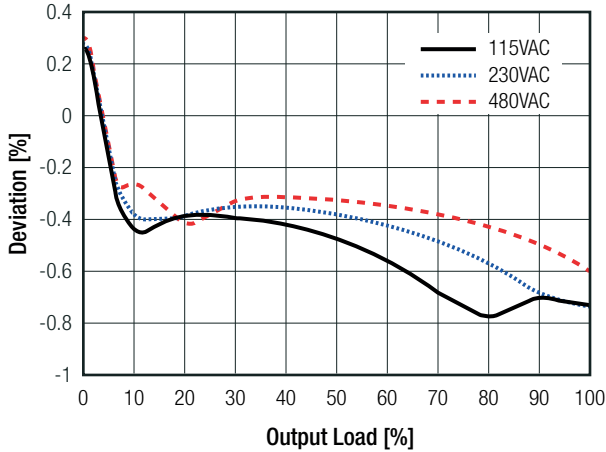

RAC25-24SK/480

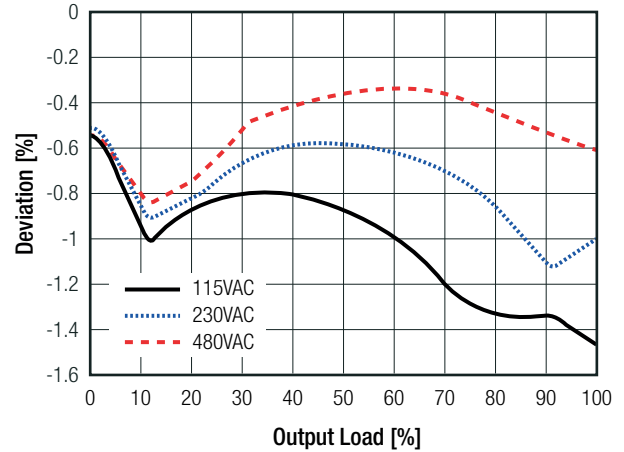

PROTECTIONS

Parameter	Type	Value
Input Fuse	external (refer to "Protection Circuit")	T2A, 600VAC min.
Limited Power Source (LPS)	according to IEC62368-1 CB Report	yes
Short Circuit Protection (SCP)	below 100mΩ	hiccup, auto recovery
Over Voltage Protection (OVP)		105% - 120%, hiccup mode
Over Current Protection (OCP)		128% - 155%, hiccup mode
Over Voltage Category	according to 61010-1	OVCIII (up to 5000m)

continued on next page

Specifications (measured @ Ta= 25°C, nom. Vin, full load and after warm-up unless otherwise stated)

Parameter	Type		Value
Isolation Voltage ⁽⁶⁾	tested for 1 minute	I/P to O/P	3.6kVAC
Isolation Resistance			1GΩ max.
Isolation Capacitance			3200pF max.
Insulation Grade			reinforced
Leakage Current			250μA max.

Protection Circuit

Notes:

Note6: For repeat Hi-Pot testing, reduce the time and/or the test voltage

An external fuse must be provided to protect the device against overcurrents caused by errors on the input side.
 Recom suggests a slow type, 600VAC, 2A, as default for AC-operation.
 Contact Recom for further Support

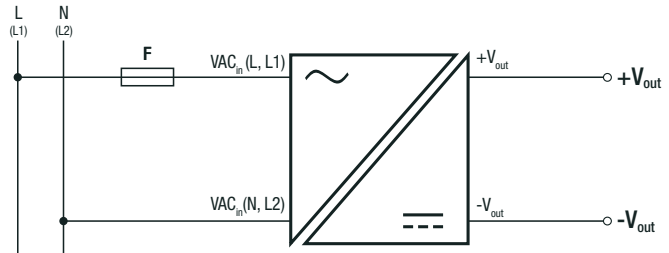

ENVIRONMENTAL

Parameter	Condition		Value	
Operating Temperature Range	refer to "Derating Graph"		-40°C to +90°C	
Maximum Case Temperature			+105°C	
Temperature Coefficient			0.02%/K	
Operating Altitude			5000m	
Operating Humidity	non-condensing		95% RH max.	
Polution Degree			PD3	
Vibration	according to MIL-STD-202G		10-500Hz, 2G 10min./1cycle, 60min. each along x,y,z axes	
Design Lifetime	230VAC/50Hz	+50°C	30 x 10 ³ hours	
MTBF	according to MIL-HDBK-217F, G.B.	V _{OUT} = 5, 12VDC	+25°C	950 x 10 ³ hours
		V _{OUT} = 15, 24VDC	+25°C	1040 x 10 ³ hours
		V _{OUT} = 5, 12VDC	+40°C	800 x 10 ³ hours
		V _{OUT} = 15, 24VDC	+40°C	920 x 10 ³ hours

Derating Graph

(@ Chamber and natural convection 0.1 m/s)

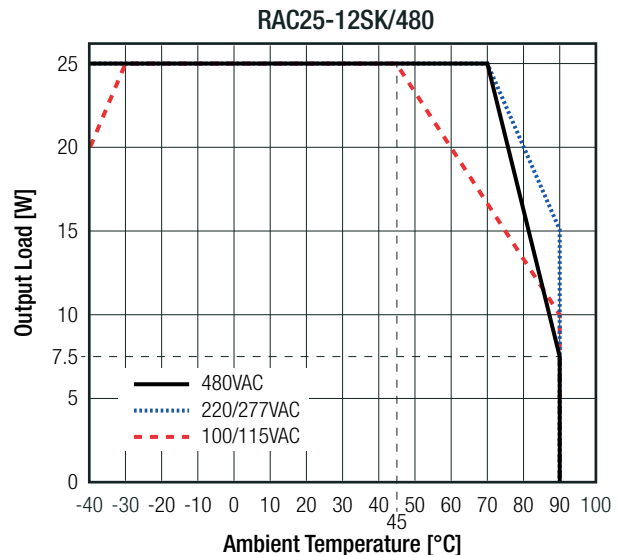
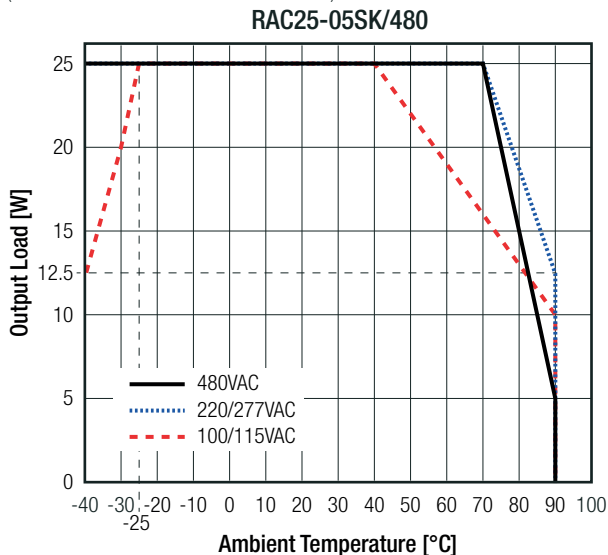

continued on next page

Specifications (measured @ Ta= 25°C, nom. Vin, full load and after warm-up unless otherwise stated)

Derating Graph

(@ Chamber and natural convection 0.1m/s)

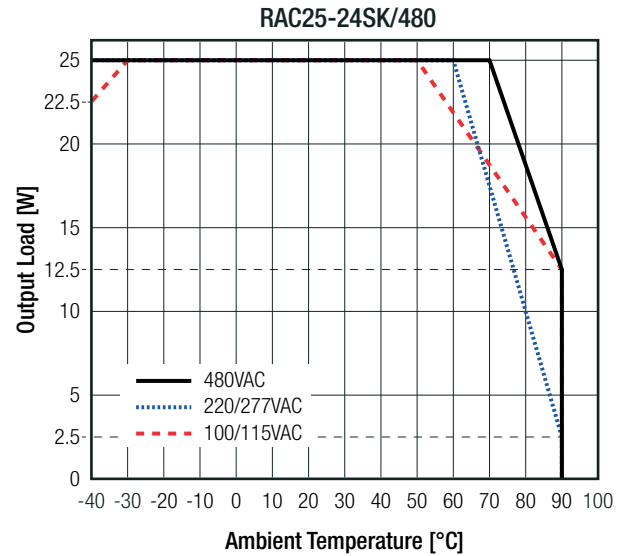
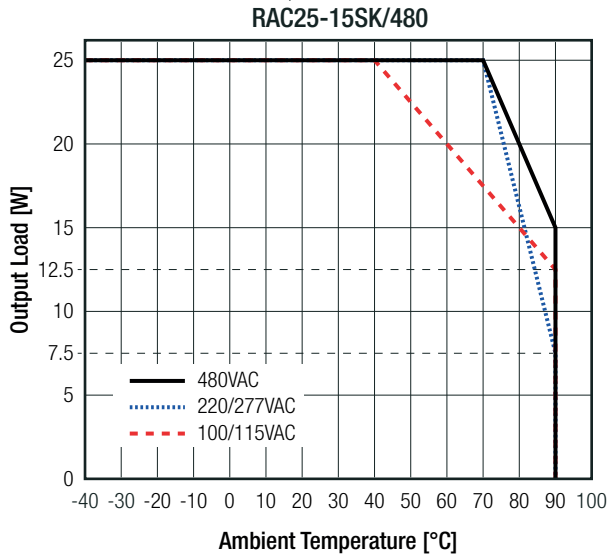

SAFETY AND CERTIFICATIONS

Certificate Type (Safety)	Report Number	Standard
Audio/Video, information and communication technology equipment - Safety requirements	E491408-A6020-UL	UL62368-1, 3rd Edition, 2019 CAN/CSA C22.2 Nr. 62368-1-14, 3rd Ed. 2019
Audio/Video, information and communication technology equipment - Safety requirements (CB)	211112013	IEC62368-1:2014 2nd Edition
Audio/Video, information and communication technology equipment - Safety requirements (LVD)		EN62368-1:2014 + A11:2017
Audio/Video, information and communication technology equipment - Safety requirements (CB)	211112012	IEC62368-1:2018 3rd Edition
Audio/Video, information and communication technology equipment - Safety requirements		EN/IEC62368-1:2020 + A11:2020
Electrical Equipment For Measurement, Control, and Laboratory Use; Part 1: General Requirements	085-210569601-000	IEC61010-1:2010 3rd Edition + A1:2019
Electrical Equipment For Measurement, Control, and Laboratory Use; Part 1: General Requirements	64.210.21.05696	EN61010-1:2010 + A1:2019
Household and similar electrical appliances – Safety – Part 1: General requirements	4389222.50	EN60335-1:2012 + A15:2020
Household and similar electrical appliances – Safety – Part 1: General requirements		IEC60335-1:2010 + A2:2016, 5th Edition EN60335-1:2012 + A15:2020
Measurement methods for electromagnetic fields of household appliances and similar apparatus with regard to human exposure		EN62233:2008
EAC		TP TC 004/2011
RoHS2		RoHS-2011/65/EU + AM-2015/863

EMC Compliance (EN55032) ⁽⁷⁾	Condition	Standard / Criterion
Electromagnetic compatibility of multimedia equipment - Emission requirements		EN55032:2015 + A11:2020, Class B
Electromagnetic compatibility of multimedia equipment – Immunity requirements		EN55035:2017 + A11:2020
ESD Electrostatic discharge immunity test	Air: ±2, 4, 8kV Contact: ±2, 4kV	EN61000-4-2:2009, Criteria A
Radiated, radio-frequency, electromagnetic field immunity test	3 V/m (80-5000MHz)	EN61000-4-3:2006 + A2:2010, Criteria A
Fast Transient and Burst Immunity	AC Port: L, N, L-N ±1kV	EN61000-4-4:2012, Criteria A
Surge Immunity	AC Port: L-N: ±1kV	EN61000-4-5:2015, Criteria A
Immunity to conducted disturbances, induced by radio-frequency fields	AC Port: 3Vrms (0.15-10MHz) 3-1Vrms (10-30MHz) 1Vrms (30-80MHz)	EN61000-4-6:2014, Criteria A

continued on next page

Specifications (measured @ Ta= 25°C, nom. Vin, full load and after warm-up unless otherwise stated)

Power Magnetic Field Immunity	1A/m	EN61000-4-8:2010, Criteria A
Voltage Dips	100% (0.5P, 0.5P) 30% (25P, 30P)	EN61000-4-11:2004, Criteria A EN61000-4-11:2004, Criteria A
Voltage Interruptions	100% (250P/300P)	EN61000-4-11:2004, Criteria B
EMC Compliance (EN61204-3) ⁽⁷⁾	Condition	Standard / Criterion
Low voltage power supplies, d.c. output Part 3: Electromagnetic compatibility (EMC)		EN IEC 61204-3:2018
ESD Electrostatic discharge immunity test	Air: ±2, 4, 8kV Contact: ±4kV	EN61000-4-2:2009, Criteria A
Radiated, radio-frequency, electromagnetic field immunity test	10V/m (80-1000MHz) 3V/m (1400-2000MHz) 1V/m (2000-2700MHz)	EN61000-4-3:2006 + A2:2010, Criteria A
Fast Transient and Burst Immunity	AC Port: L, N, L-N ±2kV	EN61000-4-4:2012, Criteria A
Surge Immunity	AC Port: L-N: ±1kV	EN61000-4-5:2014 + A1:2017, Criteria A
Immunity to conducted disturbances, induced by radio-frequency fields	AC Port: 10Vrms (0.15-80MHz)	EN61000-4-6:2014, Criteria A
Power Magnetic Field Immunity	30A/m	EN61000-4-8:2010, Criteria A
Voltage Dips	100% (0.5P, 0.5P) 100% (1.0P, 1.0P) 60% (10P, 12P) 30% (25P, 30P) 20% (250P, 300P)	EN61000-4-11:2004 + A1:2017, Criteria A
Voltage Interruptions	100% (250P, 300P)	EN61000-4-11:2004 + A1:2017, Criteria B
Limits of Harmonic Current Emissions		EN IEC 61000-3-2:2019
Limits of Harmonic Current Emissions		EN61000-3-2:2014
Limits of Voltage Fluctuations & Flicker		EN61000-3-3:2013 + A1:2019
Notes:		
Note7: With earth referenced output connections, use of an external common mode choke 45mH (E-type) may be considered at the input.		

DIMENSION AND PHYSICAL CHARACTERISTICS

Parameter	Type	Value
Material	case/baseplate	polycarbonate, (UL94V-0)
	potting	PU, (UL94V-0)
	PCB	FR4, (UL94V-0)
Dimension (LxWxH)		83.23 x 46.43 x 30.40mm
Weight		185g typ.

continued on next page

Specifications (measured @ Ta= 25°C, nom. Vin, full load and after warm-up unless otherwise stated)

Dimension Drawing (mm)

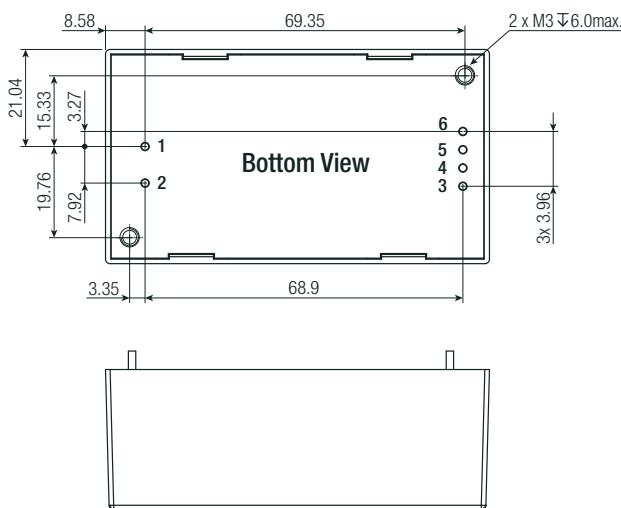
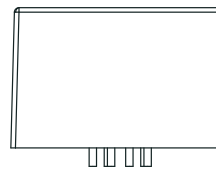
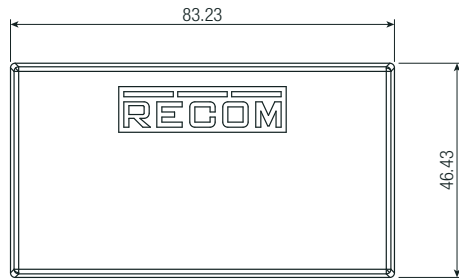

Recommended Footprint Details

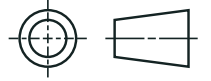
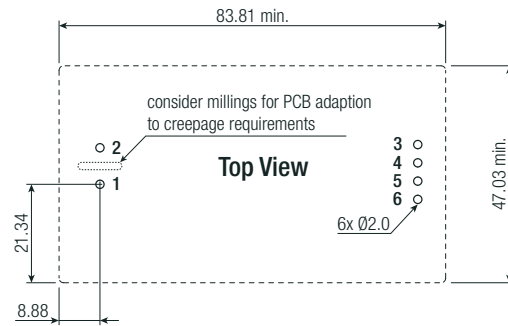

Pinning information

Pin #	Single
1	VAC in (N) (L2)
2	VAC in (L) (L1)
3	-Vout
4	-Vout
5	+Vout
6	+Vout

Tolerance: xx.x= ±0.5mm
xx.xx= ±0.25mm

PACKAGING INFORMATION

Parameter	Type	Value
Packaging Dimension (LxWxH)	tray	365.0 x 210.0 x 56.0mm
Packaging Quantity	tube	12pcs
Storage Temperature Range		-40°C to +90°C
Storage Humidity	non-condensing	95%

The product information and specifications may be subject to changes even without prior written notice. The product has been designed for various applications; its suitability lies in the responsibility of each customer. The products are not authorized for use in safety-critical applications without RECOM's explicit written consent. A safety-critical application is an application where a failure may reasonably be expected to endanger or cause loss of life, inflict bodily harm or damage property. The applicant shall indemnify and hold harmless RECOM, its affiliated companies and its representatives against any damage claims in connection with the unauthorized use of RECOM products in such safety-critical applications.